

Panasonic

Digital Super Hybrid System

User Manual

MODEL

KX-TD816E/KX-TD1232E

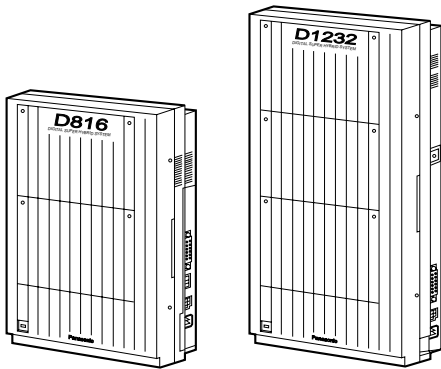

Please read this manual before connecting the Digital Super Hybrid System.

Thank you for purchasing the Panasonic Digital Super Hybrid System.

Telephones

This system can connect digital and analog Panasonic proprietary telephones. Single line devices such as a single line telephone, facsimile, cordless telephone, voice processing system, etc. can also be connected.

☞ 1-4

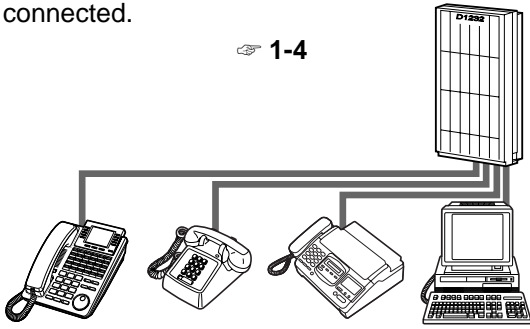

More Extensions

This system can double the extension capacity by connecting a proprietary telephone and a single line telephone. The proprietary telephone can share the extension with another single line telephone. Furthermore, you can connect a Panasonic digital proprietary telephone and a single line telephone to one jack and use them as individual extensions.

☞ 1-5

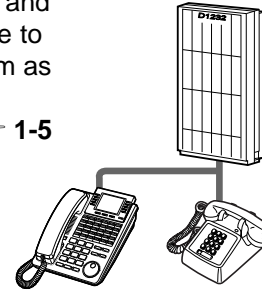

Saves on telephone charges (Automatic Route Selection)

This system chooses the most cost-effective carrier based on the outside number dialed and the time called.

☞ 2-9

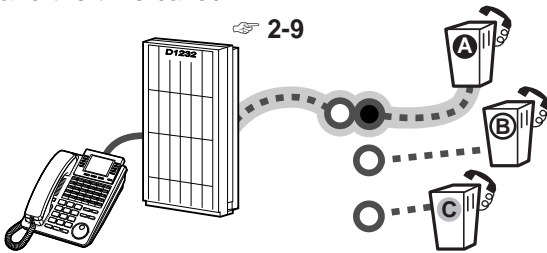

Call Record

(Station Message Detail Recording)

This system can record or print out call information: date, time, extension no., dialed no., duration, etc.

☞ Consult your dealer.

Date	Time	Ext
06/24/99	10:03 AM	123
06/24/99	11:07 AM	223

DECT System

This system optionally supports the DECT system. A DECT Portable Station (PS) can be used in the system with other wired telephone.

☞ DECT Portable Station

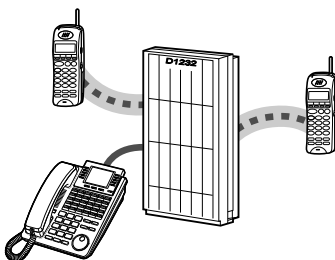

Voice Mail Integration

You can forward your call to a voice processing system and let callers leave their messages in your mailbox when you are unable to receive calls.

☞ 2-78

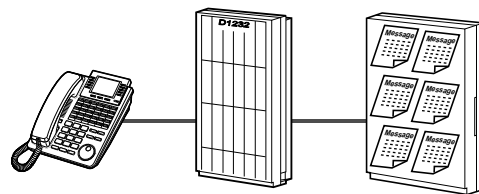

Note:

In this manual, the last letter of each model number is omitted.

Precaution

◆◆ **WARNING**

THIS UNIT MAY ONLY BE INSTALLED AND SERVICED BY QUALIFIED SERVICE PERSONNEL.

WHEN A FAILURE OCCURS WHICH RESULTS IN THE INTERNAL PARTS BECOMING ACCESSIBLE, DISCONNECT THE POWER SUPPLY CORD IMMEDIATELY AND RETURN THIS UNIT TO YOUR DEALER.

DISCONNECT THE TELECOM CONNECTION BEFORE DISCONNECTING THE POWER CONNECTION PRIOR TO RELOCATING THE EQUIPMENT, AND RECONNECT THE POWER FIRST.

THIS UNIT IS EQUIPPED WITH AN EARTHING CONTACT PLUG. FOR SAFETY REASONS THIS PLUG MUST ONLY BE CONNECTED TO AN EARTHING CONTACT SOCKET WHICH HAS BEEN INSTALLED ACCORDING TO REGULATIONS.

THE POWER SUPPLY CORD IS USED AS THE MAIN DISCONNECT DEVICE. ENSURE THAT THE SOCKET-OUTLET IS LOCATED/INSTALLED NEAR THE EQUIPMENT AND IS EASILY ACCESSIBLE.

TO PREVENT FIRE OR SHOCK HAZARD, DO NOT EXPOSE THIS PRODUCT TO RAIN OR MOISTURE.

◆◆ **WARNING**

Static sensitive devices are used. To protect printed circuit boards from static electricity, do not touch connectors indicated to the right. To discharge body static, touch ground or wear a grounding strap.

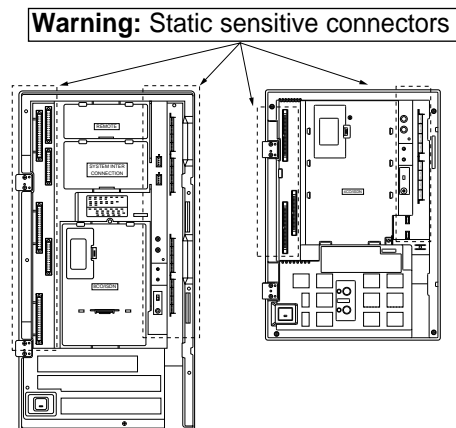

The following icons are used frequently in this manual.



Hints



Conditions

Attention

- Keep the unit away from heating appliances and electrical noise generating devices such as fluorescent lamps, motors and televisions. These noise sources can interfere with the performance of the unit.
- This unit should be kept free of dust, moisture, high temperature (more than 40°C) and vibration, and should not be exposed to direct sunlight.
- Never attempt to insert wires, pins, etc., into the vents or holes of this unit.
- If there is any trouble, disconnect the unit from the telephone line. Plug the telephone directly into the telephone line. If the telephone operates properly, do not reconnect the unit to the line until the problem has been repaired by an authorised Panasonic Factory Service Centre. If the telephone does not operate properly, chances are that the problem is in the telephone system, and not in the unit.
- Do not use benzine, thinner, or any abrasive powder to clean the cabinet. Wipe it with a soft cloth.

The serial number of this product may be found on the label affixed to the unit. You should note the model number and the serial number of this unit in the space provided and retain this manual as a permanent record of your purchase, to aid in identification in the event of theft.

MODEL NO.: _____

SERIAL NO.: _____

For future reference

DATE OF PURCHASE _____

NAME OF DEALER _____

DEALER'S ADDRESS _____

APPROVED for connection to telecommunication systems specified in the instructions for use subject to the conditions set out in them.

606055

KX-TD816

APPROVED for connection to telecommunication systems specified in the instructions for use subject to the conditions set out in them.

NS / 1010 / 235 / R / 604365

KX-TD1232

Safety Instructions

When using your telephone equipment, basic safety precautions should always be followed to reduce the risk of fire, electric shock and injury to persons, including the following:

1. Do not use this product near water, for example, near a bath tub, wash bowl, kitchen sink or laundry tub, in a wet basement or near a swimming pool.
2. Avoid using a telephone (other than a cordless type) during an electric storm. There may be a remote risk of electric shock from lightning.
3. Do not use the telephone to report a gas leak in the vicinity of the leak.
4. Use only the power cord and batteries indicated in this manual. Do not dispose of batteries in a fire. They may explode. Check with local codes for possible special disposal instructions.

SAVE THESE INSTRUCTIONS

Table of Contents

1 Overview

1-2	Capacity
1-3	Name and Locations
1-4	Connection Example
1-5	Adding Another Telephone in Parallel
1-7	Restarting the System

2 Operation

2-2	Before Operating the Telephones
2-8	Making Calls
2-8	Basic Calling
2-10	Easy Dialling
2-14	Redial
2-16	When the Dialed Line is Busy or There is No Answer
2-22	Calling without Restrictions
2-24	Alternating the Calling Method
2-25	Receiving Calls
2-25	Answering Calls
2-26	Answering Hands-free
2-27	Answering a Call Ringing at Another Telephone
2-29	Answering a Call via an External Speaker
2-30	During a Conversation
2-30	Holding a Call
2-35	Talking to Two Parties Alternately
2-36	Transferring a Call
2-38	Answering a Call Waiting
2-39	Three-party Conversation
2-41	Saving a Number
2-42	Mute
2-43	Letting Other People Listen to the Conversation
2-44	Before Leaving Your Desk
2-44	Forwarding Your Calls
2-48	Forwarding Calls from a Receiving Group
2-49	Showing an Absent Message on the Caller's Telephone Display
2-52	Preventing Other People from Using Your Telephone
2-53	Leaving a Call Distribution Group
2-54	Making / Answering an Announcement
2-54	Paging
2-57	Paging a Person and Transferring a Call
2-59	Answering a Paged Announcement
2-61	Setting the Telephone According to Your Needs
2-61	Setting the Alarm
2-63	Refusing Incoming Calls
2-65	Receiving a Call Waiting
2-66	Denying the Paged Announcement
2-67	Displaying Your Number on the Called Party and Calling Party's Telephone
2-68	Preventing Your Number Being Displayed on the Called Party's Telephone
2-69	Preventing Your Number Being Displayed on the Calling Party's Telephone
2-69	Denying Other People the Possibility of Picking up Your Calls
2-70	Turning on the Background Music
2-70	Checking the Day / Night Service Status
2-71	Setting the Parallel Connected Telephone Ringer
2-73	Clearing the Feature Settings at Your Extension
2-74	Using User-supplied Equipment
2-74	If a Doorphone / Door Opener is Connected
2-75	Forwarding Doorphone Calls to Outside Parties
2-77	If a Host PBX is connected
2-78	If a Voice Processing System is Connected
2-83	Using the Display Proprietary Telephone
2-83	Calling Using the Call Log
2-85	Recording a Call Log
2-86	Denying Other People the Possibility of Seeing Your Call Log
2-87	Using the KX-T7431, KX-T7433, KX-T7436 or KX-T7235

3

Operator Operation

3-2	Extension Control
3-2	Assigning Level of Service
3-3	Changing the Settings
3-4	System Control
3-4	Forwarding a Waiting Call
3-5	Day / Night Service
3-7	Turning on the External Background Music
3-8	Recording Outgoing Messages
3-9	Using the ANSWER / RELEASE Button
3-10	Hotel Use Features
3-15	Printing the System Working Report

4

Customising Your Phone & System

4-2	Customising Your Phone (Station Programming)
4-2	Initial Settings
4-4	Customising the Buttons
4-7	Charge Fee Management
4-8	Customising Your System (System Programming)
4-8	Programming Information
4-14	Date and Time Set (000)
4-15	System Speed Dialling Number Set (001)
4-16	System Speed Dialling Name Set (002)
4-23	Extension Number Set (003)
4-24	Extension Name Set (004)

5

DECT Portable Station

5-2	Safety Instructions
5-4	Before Operating the DECT Portable Station
5-6	Operation
5-9	Making Calls
5-11	Receiving Calls
5-12	Redial
5-13	Holding a Call
5-15	Transferring a Call
5-16	Using the Call Directory
5-23	Using Your PS in Parallel with the Wired Telephone
5-25	Locking the Keypads
5-26	Selecting the Feature Button on the Display
5-27	Other Operations
5-33	Customising Your PS & System
5-33	Programming Information
5-34	PS Programming
5-39	PBX Programming
5-40	Troubleshooting

6

Appendix

6-2	Troubleshooting
6-5	Feature Number List
6-8	Directory
6-15	What is This Tone?
6-18	Specifications
6-19	Quick Reference Card for a Single Line Telephone

7

Index

7-2	Index
-----	--------------



Overview

This section briefly outlines your system.

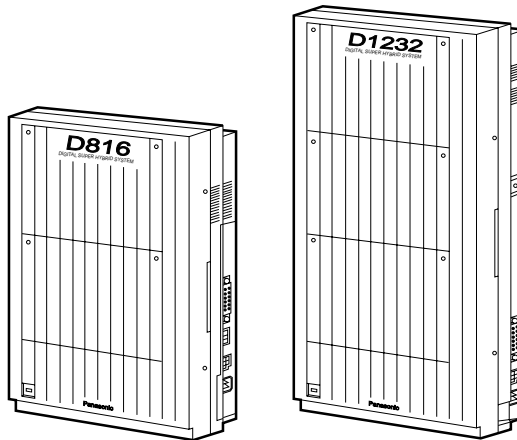

Capacity

You can connect the following number of extensions and outside lines to your system.

	Basic System	With optional units	System Connection
KX-TD816			
Outside line	0	8	—
Extension	8	16	—
KX-TD1232			
Outside line	0	12	24
Extension	16	32	64

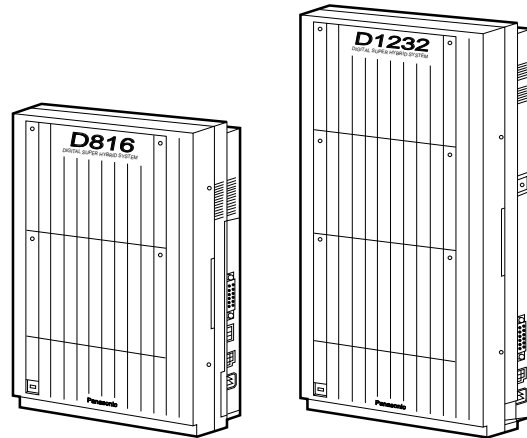

Names and Locations

KX-TD816

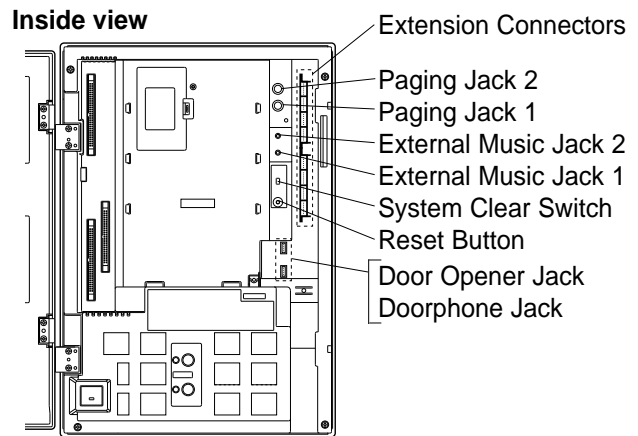
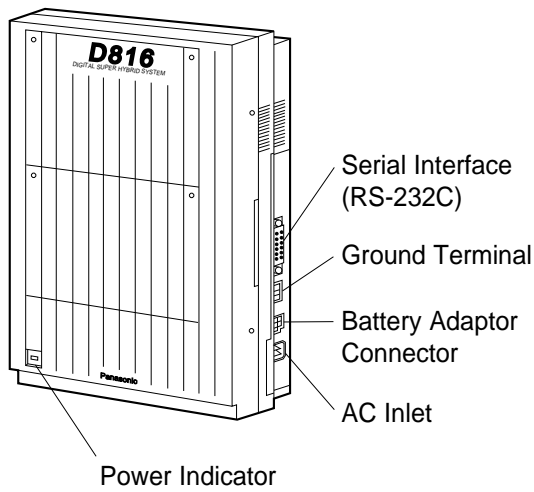

KX-TD1232

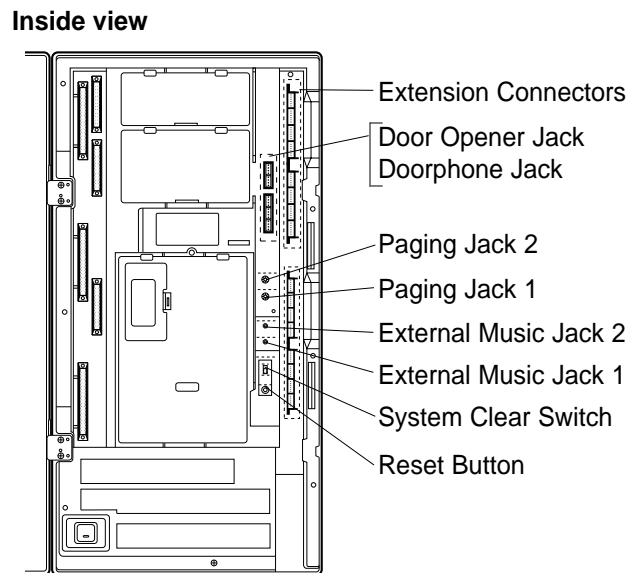
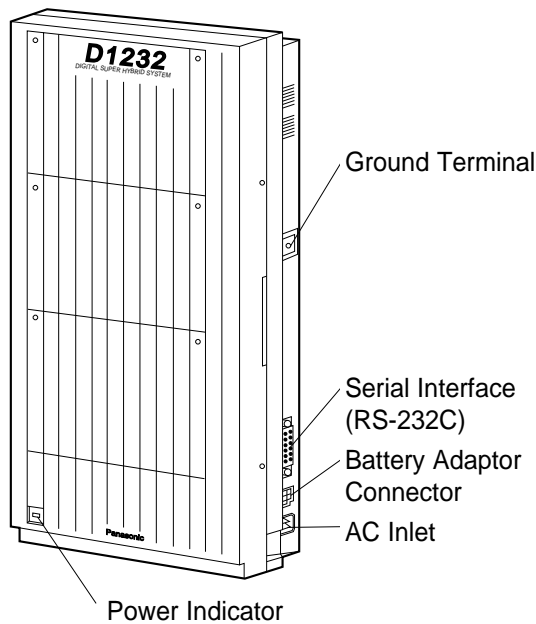

To open the front cover

- Loosen the two screws on the right side of the main unit.
The two screws are attached to the front cover with springs so that they will not be lost.

- Open the front cover in the direction of arrow **A**.

To close the front cover

- Reverse the steps above.

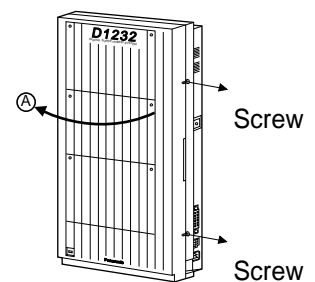

Connection Example

This diagram shows you a connection example including optional equipment.

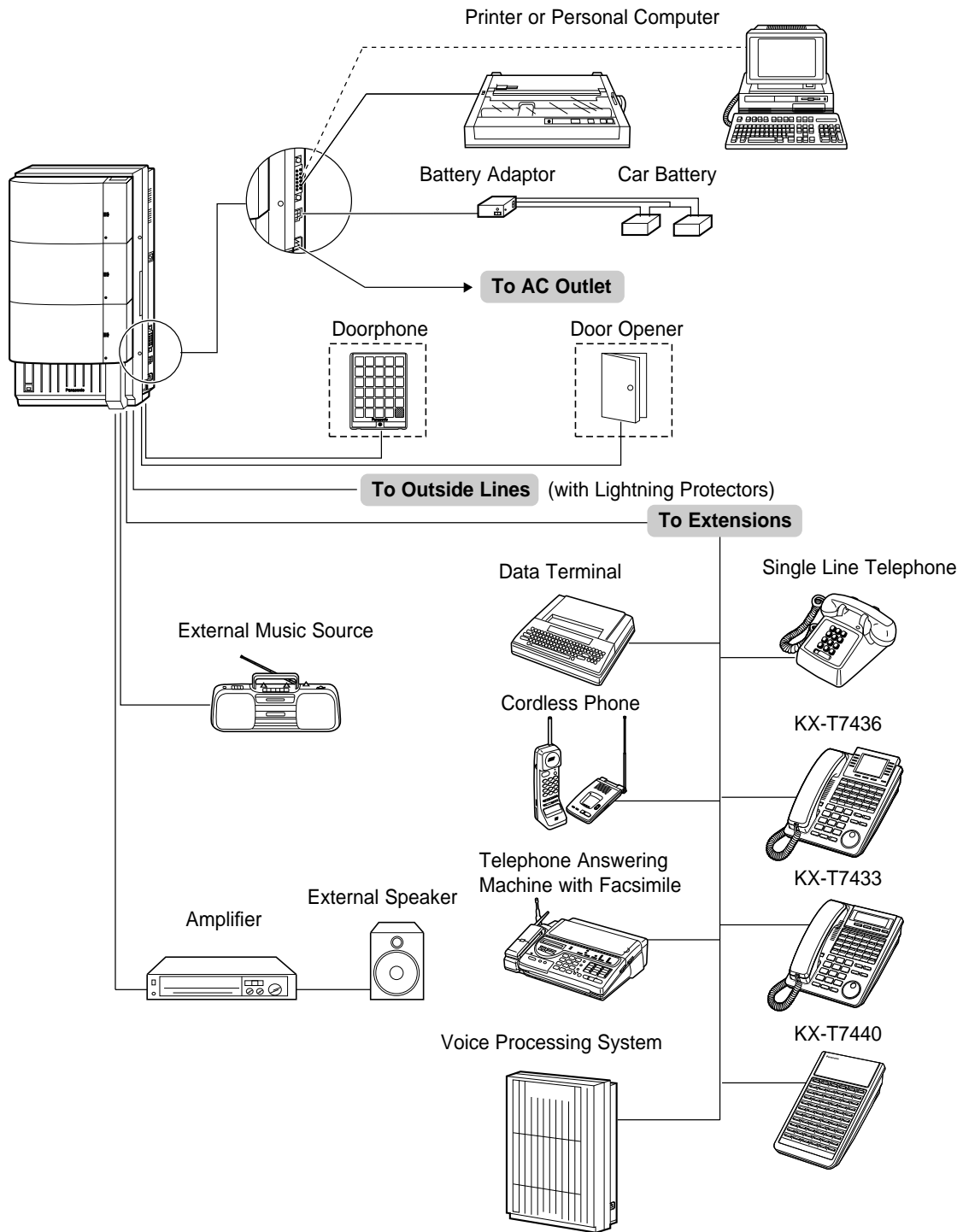

  : needs Optional Cards or Adaptor.

Adding Another Telephone in Parallel

A Panasonic proprietary telephone and a single line telephone, including a facsimile, cordless telephone, etc., can be connected to one extension jack in parallel. There are two types of parallel connections.

• Paralleled Telephone Connection

- Any proprietary telephone and a single line telephone

These telephones share the same extension number. Follow Method 1 or 2.

To ring the single line telephone, set to ring (on) if necessary. (“Setting the parallel connected telephone ringer” in “Operations”)

• EXtra Device Port (XDP)

- Digital proprietary telephone and a single line telephone

Each telephone has a different extension number and can work individually. For more information, contact your dealer. Follow Method 2 or 3.

Method 1

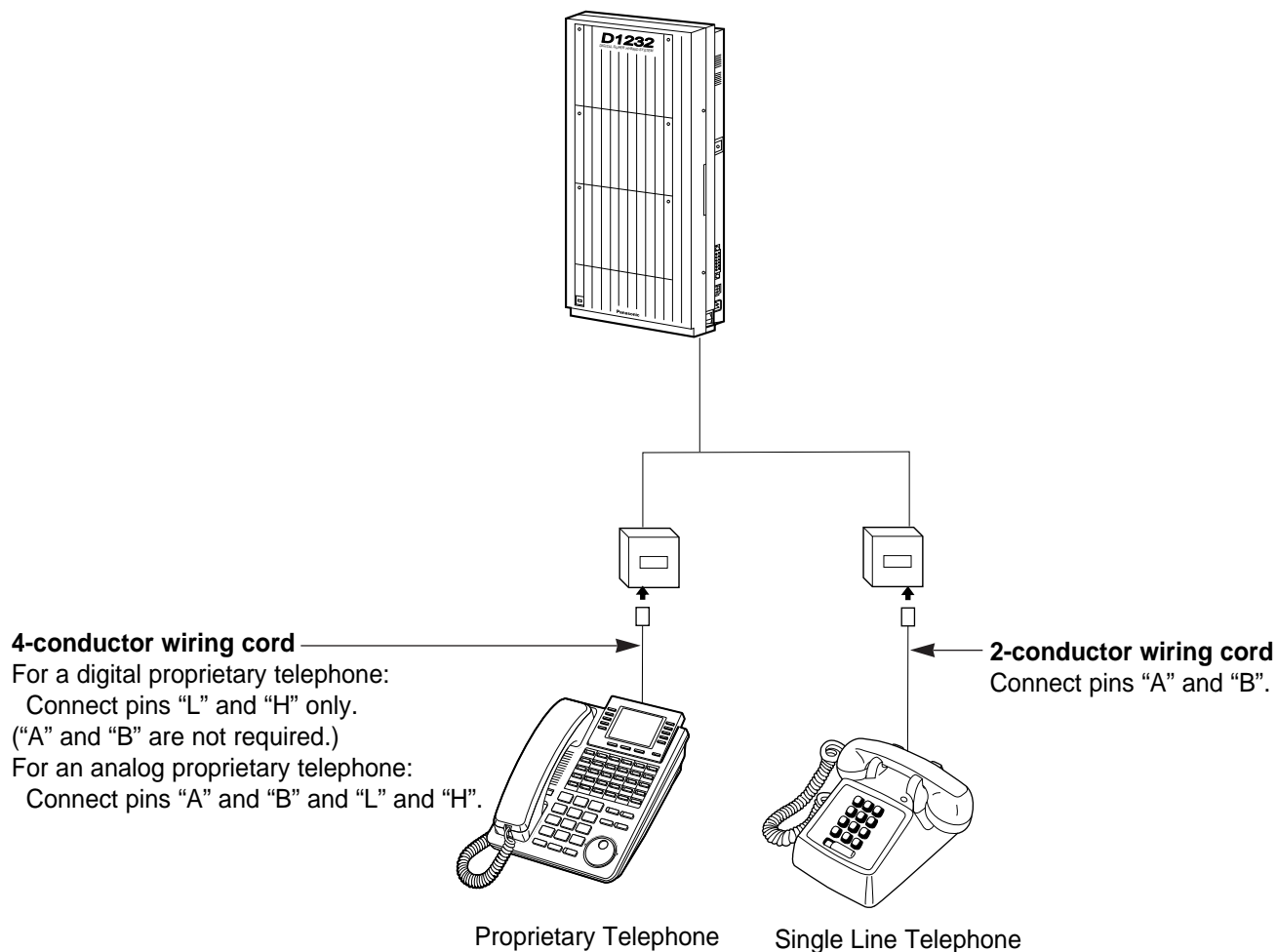

Adding Another Telephone in Parallel

Method 2

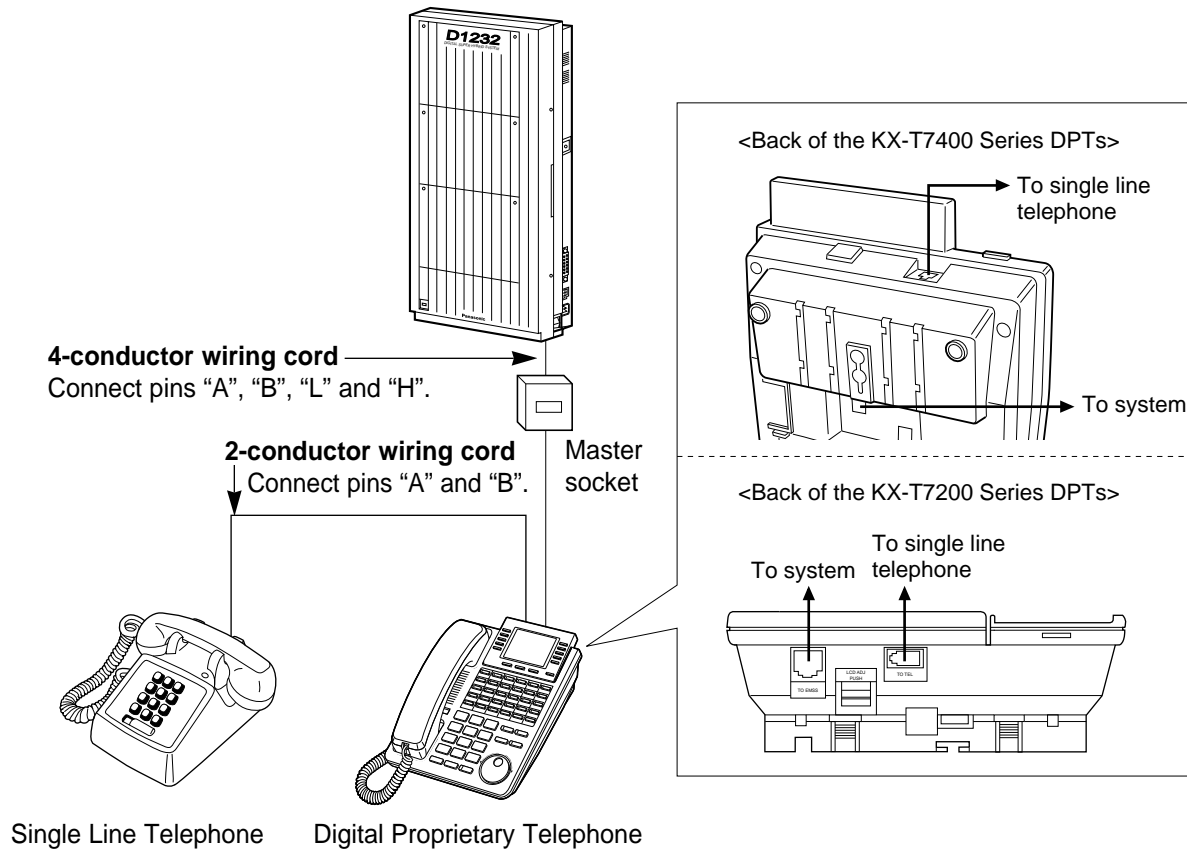

Method 3

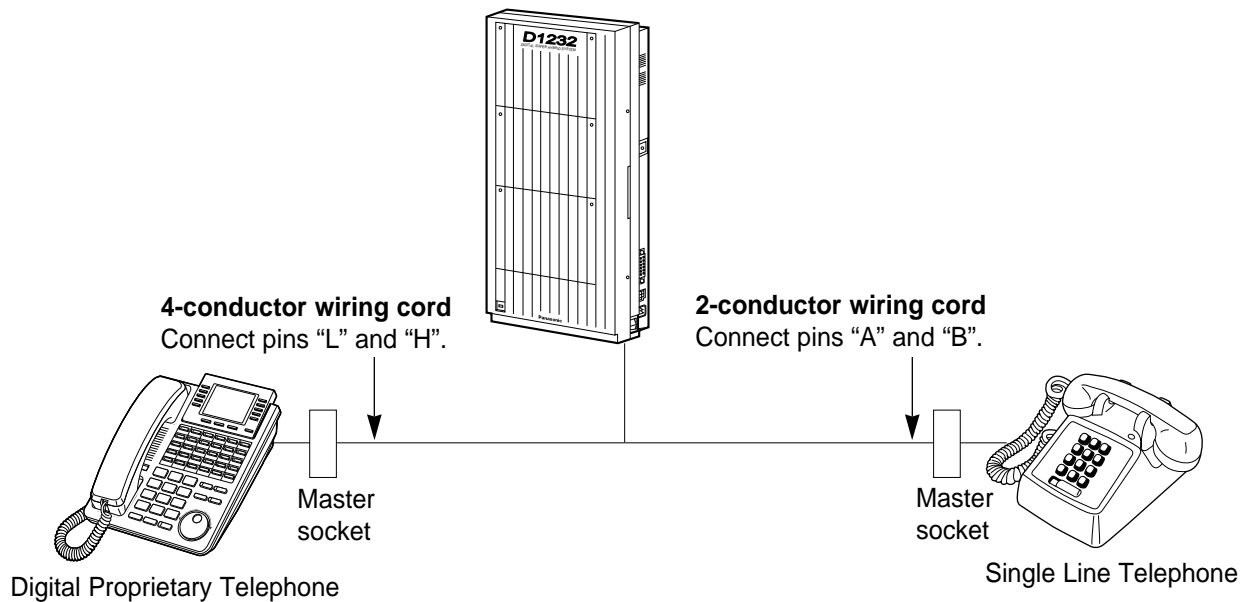

Restarting the System

After starting the system, if it does not operate properly, restart. Only the following will be cleared. If your system does not operate properly, consult your dealer.

- Automatic Callback Busy (Camp-On) is cleared.
- Calls in system parking zones are cleared.
- Calls on Hold are terminated.
- Calls in progress are terminated.
- Calls on Exclusive Hold are cleared.

1. Make sure that the System Clear Switch is set to the “NORMAL” position.
2. Press the Reset Button with a pointed object.

KX-TD816

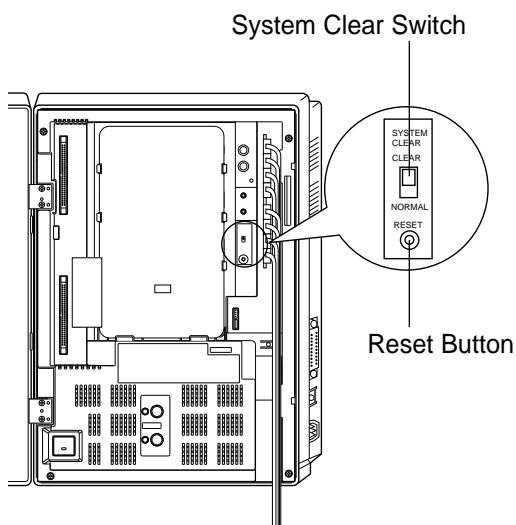

KX-TD1232

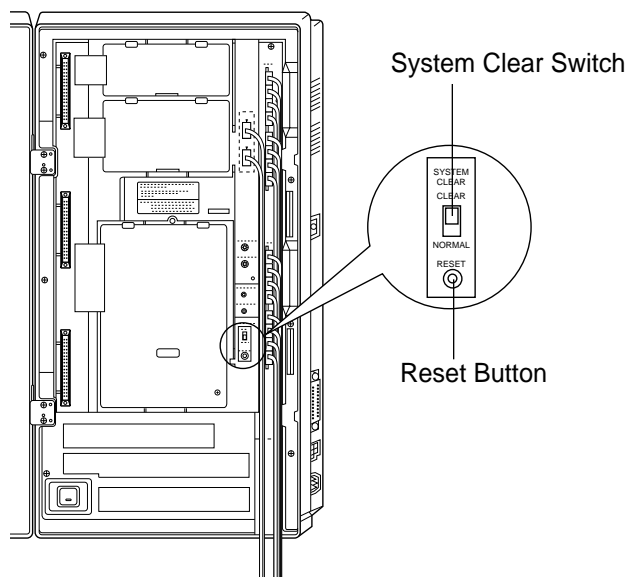

Notice:

- If, after pressing the Reset Button, you notice that the System Clear Switch was in the “CLEAR” position, do not change it to the “NORMAL” position for at least 30 seconds. Otherwise all the system programming data will reset to default values. Slide to the “NORMAL” position over 30 seconds later. Then the system works as before.

2

Operation

This chapter shows you how to operate each feature step by step.

Read this chapter to become familiar with the many useful features of this system.

Before Operating the Telephones

◆◆ What kind of telephone can be used?

You can use a single line telephone (SLT), such as a rotary pulse telephone or a Panasonic proprietary telephone (PT) such as the KX-T7436. Operate the feature depending on the telephone you are using. If you are using a Panasonic proprietary telephone with a special function button such as  and/or has a display (D – PT), you can follow the operation with the button or display messages for easy programming.

If you use a large display telephone (e.g. KX-T7436), you can follow the displayed messages to operate the features.

If your telephone does not have function buttons and/or a display, you may operate the unit by entering a feature number instead. Follow the available operation with your telephone.

If you use a Console, you can use the buttons on the Console as the buttons on the connected proprietary telephone.

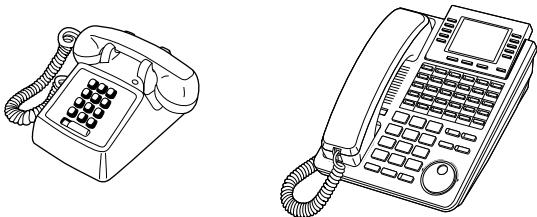

- If you use a Panasonic proprietary telephone which does not have function buttons, you may change one of the unused flexible buttons to a function button. Refer to “Customising the Buttons” (Customising Your Phone & System).

◆◆ Feature Numbers

To operate certain features, you need to enter specified feature numbers (and an additional parameter, if required).

There are two types of feature numbers as follows:

- Flexible feature number
- Fixed feature number

Fixed feature numbers cannot be changed. However, you can change the flexible numbers to other numbers for easier use. If you want to change the numbers, consult your dealer. In this manual, the default numbers (factory installed) are used for operations.

A flexible number is shown as  (half-shaded key). Use the new programmed number if you have changed the feature number. Write the new number in the “Feature Number List” (Appendix).



If you use a single line telephone which does not have the “*” or “#” keys; it is not possible to access features that have “*” or “#” in their feature numbers.

◆◆ Tones

You will hear various tones, during or after an operation, for confirmation. Refer to “What is This Tone?” (Appendix).



◆◆ Display

In this manual, you will see “the display ...”. This refers to the display of a Panasonic proprietary telephone. If your telephone is not a Panasonic proprietary telephone with a display, the message will not be displayed.

If you use a Panasonic display proprietary telephone, the display helps you confirm the settings. For example, when you set the Do Not Disturb feature, the display shows “Do Not Disturb”. Some proprietary telephones also give you easy access to operations. A message is displayed depending on the operation. By pressing the corresponding button on the side or bottom of the display, or rotating a jog dial, you can access the desired feature. For example, if turning background music on becomes available, “BGM” will be shown on the display. Follow the instructions in each operation.

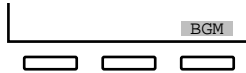

Furthermore, depending on the display proprietary telephone, you can operate features or make calls using the display message. Refer to “Using the Display Proprietary Telephone”.

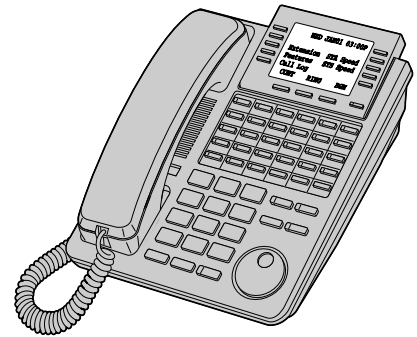

◆◆ Your Extension Number

If you use a Panasonic display proprietary telephone, you can check your own extension number on the display. Refer to “Customising Your System – Programming Information” (Customising Your Phone & System).

◆◆ Examples

The displays and the illustrations shown as examples are from a telephone connected to the KX-TD1232.

◆◆ Restrictions

Some features may be restricted at your extension under system programming. Consult your manager or dealer.

Before Operating the Telephones

◆◆ Icon Descriptions

The following icons show you the feature availability, notes and action to operate the features. While operating the unit, you can easily refer to the Icons noted on the inside back cover of this manual.



This feature cannot be operated with a single line telephone.



Related Programming Title
See "Programming", if necessary.



Off-hook (One of the following).
 • Lift the handset.
 • Press the SP-PHONE button.
 • Press the MONITOR button. (To start talking, lift the handset.)



On-hook (One of the following).
 • Hang up.
 • Press the SP-PHONE button.
 • Press the MONITOR button.



Press the corresponding function button on the proprietary telephone. (See to "When You Use a Panasonic Proprietary Telephone".)

desired no.

Enter the required number.

<Example>

account code

Enter the account code.

extension no.

Dial an extension number.

phone no.

Dial the telephone number.



(CO)

OR



OR



to



Seize an external line (One of the following).
 • Press the CO button.
 • Dial automatic line access number 0.
 • Dial outside line number 81 to 88.



Press the Call button on the Doorphone.



(Recall)

Press the Recall button on a single line telephone.



Wait for an answer.



Talk.



You will hear a confirmation, dial, ring or ringback tone.

C. Tone: confirmation tone

D. Tone: dial tone

R. Tone: ring tone

R. B. Tone: ringback tone



One short beep



◆◆ When You Use a Panasonic Proprietary Telephone

If you use a Panasonic proprietary telephone and the Console, they may have some of the useful function buttons listed below. These buttons make operations simple. The illustrations may differ from the buttons on your telephone.

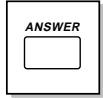

ANSWER: Used to answer an incoming call.

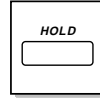

HOLD: Used to place a call on hold.



AUTO ANSWER / MUTE: Used to receive an incoming intercom call in the hands-free mode or mute the microphone during a conversation.

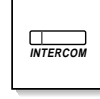

INTERCOM: Used to make or receive an intercom call.



AUTO DIAL / STORE: Used for System Speed Dialling or storing program changes.



MESSAGE: Used to leave a message waiting indication or call back the party who left the message waiting indication.

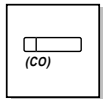

CO: Used to make or receive an outside call. A Loop-CO button supports all lines. Pressing this button seizes an idle line automatically. (Button assignment is required.)
(Only the CO "number" (e.g. 1, 2) may be shown on some telephones.)

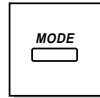

MODE: Used to shift the display to access various features.

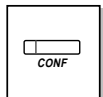

Conference: Used to establish a three-party conversation.

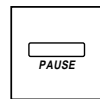

PAUSE: Used to insert a pause during dialling. Used to enter the programming mode instead of using the PROGRAM button.

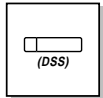

DSS: Used to access the extension. (Only the "S" may be shown on some telephones.)

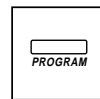

PROGRAM: Used to enter and exit the Programming mode.

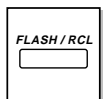

FLASH / RCL: Used to send a flash signal to the Central Office or another connected PBX. Or used to disconnect the current call and make another call without hanging up.

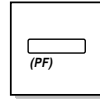

Programmable Function: *Located on the upper part of the CO button or on the DSS Console.* Assigns the desired button and used to access the stored function. Mostly used as a one-touch dialling button. (Only the "F and number" may be shown on some telephones.)

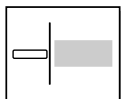

Function: *Located beside the display.* Used to perform the displayed function or operation.

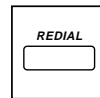

REDIAL: Used to redial.

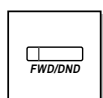

Call Forwarding / Do Not Disturb: Used to perform Call Forwarding or Do Not Disturb.



RELEASE: Used to disconnect the line.

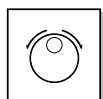

Jog Dial: Used to adjust the volume and the display contrast or select desired items for each function.

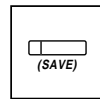

SAVE: Used to store a dialled phone number and redial.

Before Operating the Telephones

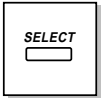

SELECT: Used to select the displayed function or to call the displayed phone number.

If the term is in parentheses like (Account) in this section, it means a flexible button has been made into an "Account" button.



SHIFT: Used to alternate between the subfunctions on the display.



Soft: Used to perform a function or operation appearing on the bottom line of the display.



Speakerphone: Used for the hands-free operation.



TRANSFER: Used to transfer a call to another party.

◆◆ Using a Jog Dial

The Jog Dial can be used for the display contrast and the volume control or you can search for desired items on the display. Rotate the Jog Dial in the either direction as desired. The contrast or the volume level and the items will change as follows:

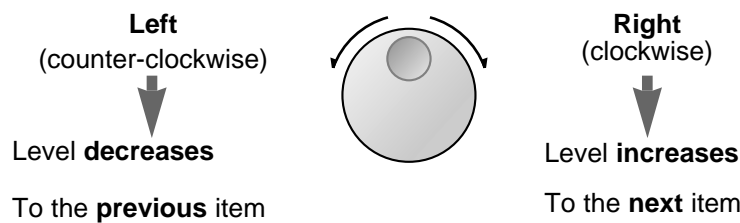

◆◆ How to Follow the Steps

A sample operation is shown below.

Feature title

Calling Without a Restriction

◆◆ **Using an account code (Account Code Entry)**

An Account Code gives information about outside calls for accounting and billing purposes. You may not be able to make an outside call without an account code entry. The mode is assigned to each user. Ask your manager for your mode.

Sub feature title

Description

PT / SLT

Off-hook.

ACCNT

 OR

(Account)

 OR

4 9

account code

 Enter **account code**
(max. 10 digits).

#

 OR

9 9

Press # or dial 99.

C.Tone

(CO)

 OR

line access no.

phone no.

 Enter **phone number.**

Press **CO** or enter **line access number**
(9 or 81-88).

Operation steps

The description of the icons are explained on page 2-4 and the inside back cover of this manual.

Conditions

- **A Panasonic proprietary telephone user** can enter an account code during a conversation and when hearing a reorder tone after the other party hangs up.
- **If you enter the wrong code**, press the "x" key while entering the account code and then re-enter the code.
- **To cancel the entry**, press the Account button or the hookswitch while entering the code.
- **For your convenience**, you can store the code with the phone number in memory (e.g. Speed dialling).
- **If you hear a reorder tone**, the entered account code is wrong. Enter the correct code.

Customising Your Phone

- **Customising the Buttons**
Create or re-arrange an Account button.

Hints

!!

You may give a specified account code to extension users and check their telephone usage. You can specify an account code to each client and check the call duration.

Programming References: The related or required programming is noted. To programme, see "Customising Your Phone & System".

Making Calls

Basic Calling

Calling another extension

To another extension (Intercom Call)

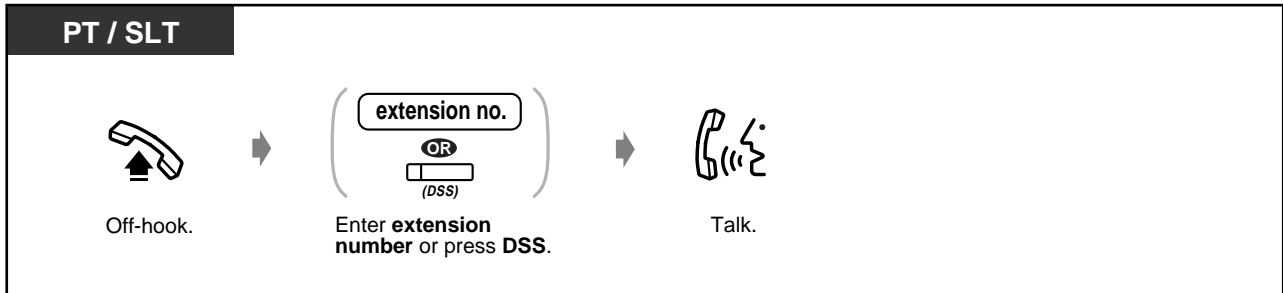

<Example>
When you call Mr. Thomas....
Mr. Thomas's extension number is 123.

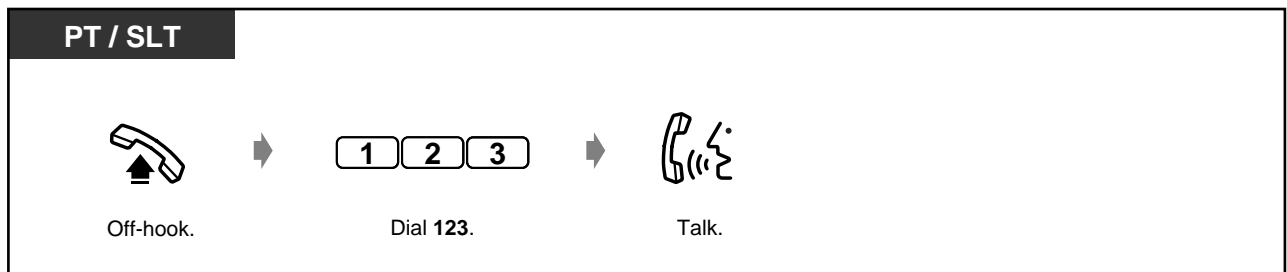

- The DSS button light shows the current status as follows:
Off: The extension is idle.
Red on: You or another extension is using the line.



Customising Your Phone

- Customising the Buttons**
Create or re-arrange a DSS button.
- Customising Your System**
 - System Speed Dialling Number Set
 - System Speed Dialling Name Set



- Do you have an extension directory?**
Complete the directory on page 6-8 and make a photo copy for your reference.
- For quick operation**
If you are an operator or dial some extensions frequently, the DSS button is useful.
- Confirming the dialled number before connecting**
You can go off-hook after confirming the number you dialled. If you misdial, press "*" to clear each number from the right or press the FLASH/RCL button to clear all numbers.

To an operator (Operator Call)

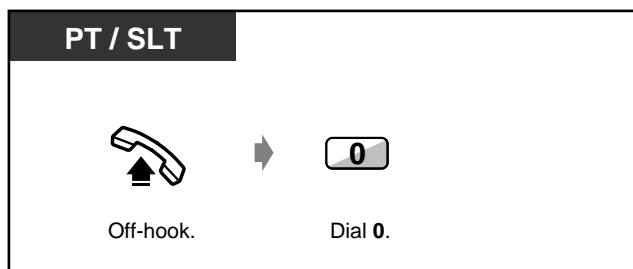









◆◆ Calling an external party

You have to seize an outside line before dialling an outside phone number because external calls are made via your system.

Select one of the following methods:

- Press an idle  button.
- Dial automatic line access number  .
An idle line is selected automatically.
- Dial outside line number   to   .
A specific line is selected.

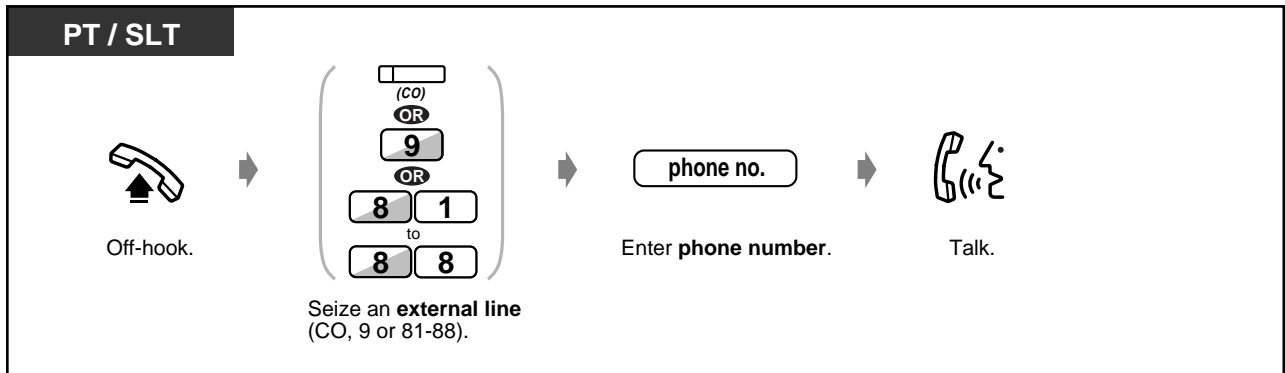

- The CO button light shows the current status as follows:
 - Off:** The line is idle.
 - Green on:** You are using the line.
 - Red on:** The line is in use.
- CO1 to CO8 correspond to outside line numbers 81 to 88 respectively.
- **Emergency call**
You can dial pre-programmed emergency numbers without any restrictions.
(Default: 999, 112)



Customising Your Phone

- **Initial Settings – Preferred Line Assignment — Outgoing**
Select the seized line when going off-hook.
- **Customising the Buttons**
Create or re-arrange the Terminate button.
- **Charge Fee Management**



Hands-free operation

You can have a conversation in the hands-free mode using the SP-PHONE button. You can then perform other tasks at the same time.

Helpful hints for hands-free operation

- Use your telephone in a quiet room for best performance.
- If the other party has difficulty hearing you, decrease the volume.
- If you and the other party talk at the same time, parts of your conversation will be lost. To avoid this, talk alternately.

To select the less expensive line automatically, dial “9” or press the Loop-CO button to seize a line. (Automatic Route Selection)

Confirming the dialled number before connecting

You can go off-hook after confirming the number you dialled. If you misdial, press “✕” to clear each number from the right or press the FLASH/RCL button to clear all numbers.

Call information

The following information can be referred to by repeatedly pressing the CO button in use.

- Phone number (outgoing call) or call duration (incoming call)
- Meter
- Call charge

To call another party without hanging up, just press the Terminate button or “TRM” button on the display, re-access an outside line and dial the new phone number.

Making Calls

Easy Dialling

This is convenient for frequently dialled phone numbers.

- With one touch button
- Using numbers stored at your extension
- Using numbers stored in the system
- To a pre-set party by going off-hook
- Using a single digit number
- To a Phantom extension

◆◆ With one touch button (One-Touch Dialling)

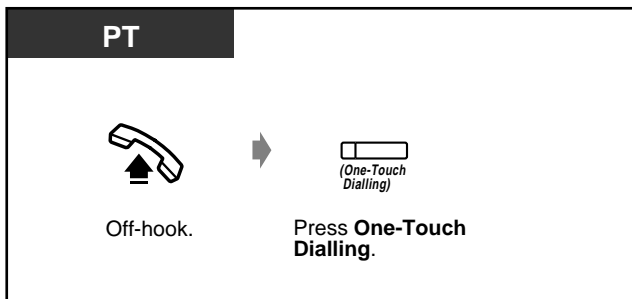

☞ Customising Your Phone

• Initial Settings – Full One-Touch Dialling Assignment

Allow or cancel the one-touch operation while on-hook. (Default: Allow)

• Customising the Buttons

Create or re-arrange the One-Touch Dialling button and store the desired number, phone number, feature number, etc.

◆◆ Using numbers stored at your extension (Station Speed Dialling)

You can store up to ten numbers at your extension for your personal use.

◆ To store a phone number

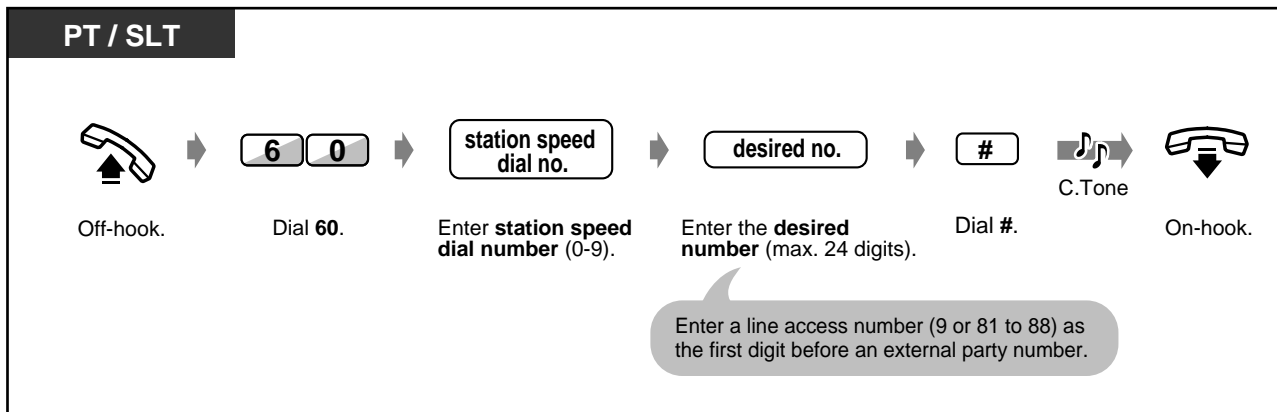

- “*” and PAUSE can also be stored as digits.



◆ To dial

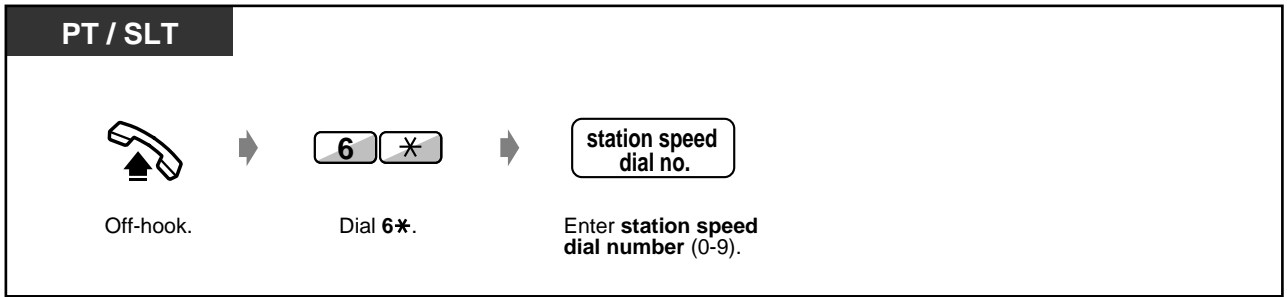

◆◆ Using numbers stored in the system (System Speed Dialling)

Up to 500 parties can be stored in the system. Refer to the directory on page 6-10.

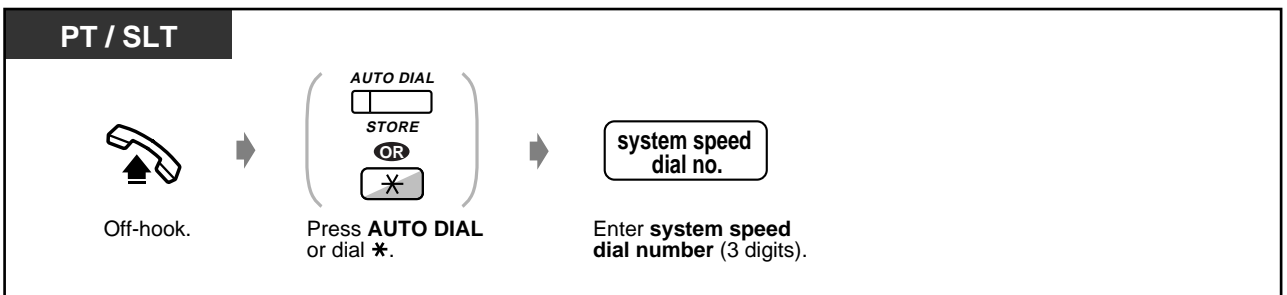

- More than one speed dial number can be used for long telephone numbers, if the number is divided when stored.

<Dialling Example>

If the number is divided and stored in system speed dial numbers 001 and 002:

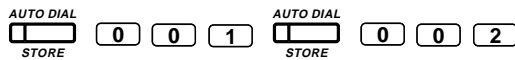

Customising Your System

- System Speed Dialling Number Set
- System Speed Dialling Name Set

Making Calls

◆◆ To a pre-set party by going off-hook (Pickup Dialling)

You can make an outside call simply by going off-hook if you pre-assigned.

◆ To store a phone number

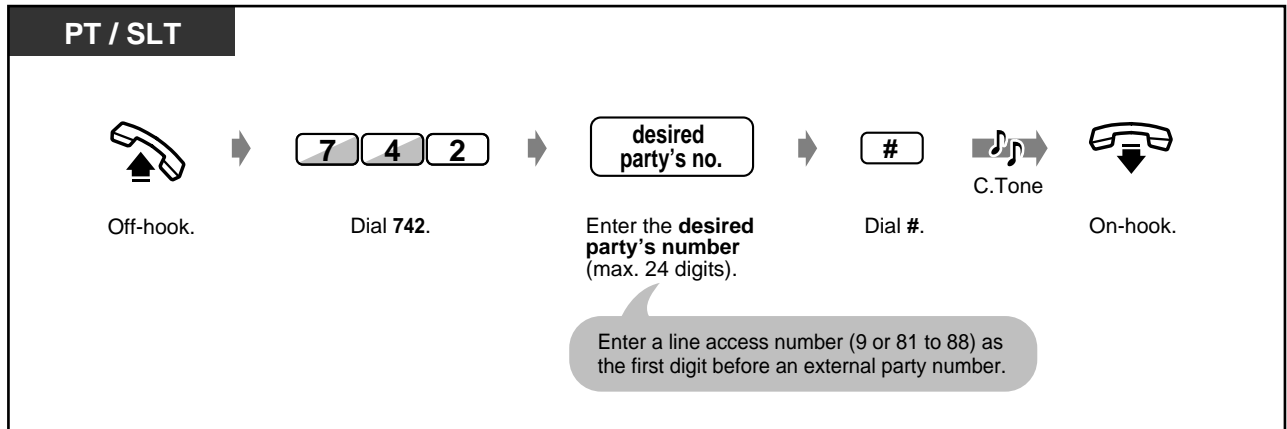

◆ To set / cancel

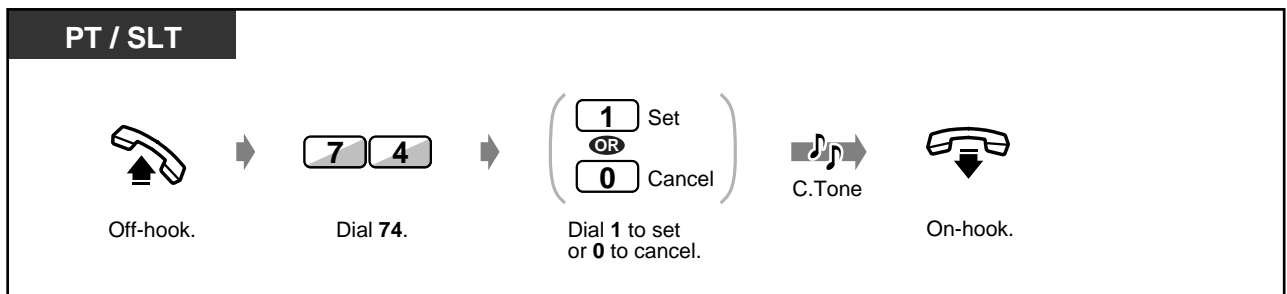

◆ To dial



- You can set or cancel this feature by simply pressing the Pickup Dialling button. If set, the button light turns red.
- **To call another party**, dial the desired party's phone number before the pre-set line is connected. (Default: 1 second)
- “*” can also be stored as a digit.
- This feature is not available for an ISDN telephone user.



Customising Your Phone

• Customising the Buttons

Create or re-arrange a Pickup Dialling button.

◆◆ Using a single digit number (Quick Dialling)

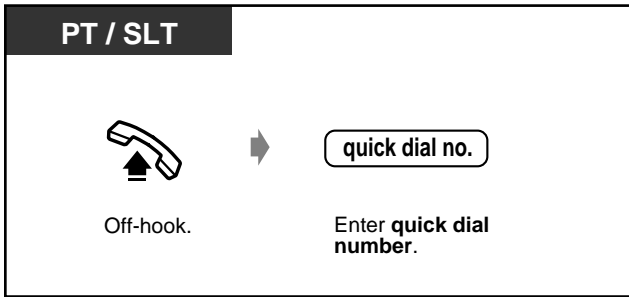

◆◆ To a Phantom extension

You can call extensions associated with a Phantom extension. The call arrives at all extensions who have the corresponding Phantom extension button.

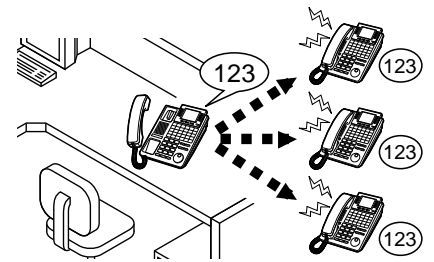

◆ To call or transfer to a phantom extension

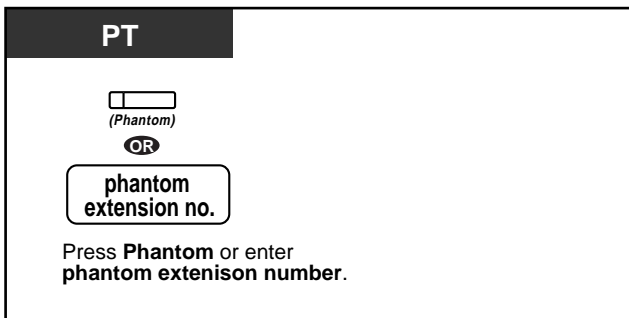

◆ To answer

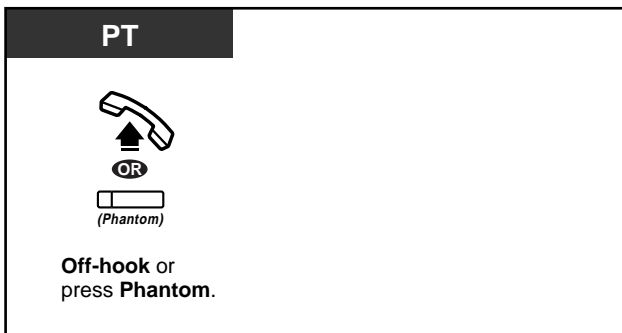

- The Phantom extension button light shows the current status as follows:
 - Off:** Idle
 - Red on:** You are calling a phantom extension.
 - Flashing green:** Incoming call
- To set ringing or not, refer to "Customising Your Phone".



Customising Your Phone

- **Customising the Buttons**
 - Create or re-arrange a Phantom extension button.

Making Calls

Redial

This is convenient when calling the same external party again.

- Redialling the last number you dialled
- Saving the number and redialling



- Up to twenty-four digits can be programmed and redialled. The line access number is not counted as a digit.



Customising Your Phone

- **Initial Settings – Full One-Touch Dialling Assignment**
Allow or cancel the one-touch operation while on-hook. (Default: Allow)



- **To redial automatically**, go off-hook with the SP-PHONE button or press the REDIAL button directly. It will keep trying the busy number until the called party answers within a specified time (Automatic Redial). You can perform other tasks during dialling. To cancel, press the RECALL/RCL button.

◆◆ Redialling the last number you dialled (Last Number Redial)

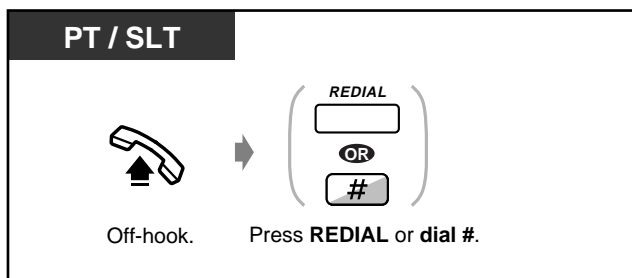



◆◆ Saving the number and redialling (Saved Number Redial)

The saved number is programmed until another number is stored.

◆ To save

PT

During a conversation or while hearing a busy tone

AUTO DIAL



STORE

Press **STORE**.

➔



(Save)

Press **SAVE**.

◆ To dial

PT



Off-hook.

➔



(Save)

Press **SAVE**.



Customising Your Phone

- **Customising the Buttons**
Create or re-arrange a SAVE button.

Making Calls

When the Dialed Line is Busy or There is No Answer

- Reserving a busy line
- Leaving a message waiting indication
- Completing a call to a busy party on an ISDN line
- Joining an existing call
- Sending a call waiting tone

Reserving a busy line (Automatic Callback Busy)

You can set the telephone to receive call-back ringing when a dialed line becomes idle.

When you answer the call-back ringing:

For an outside call: The line is seized.

For an intercom call: The called extension starts ringing automatically.

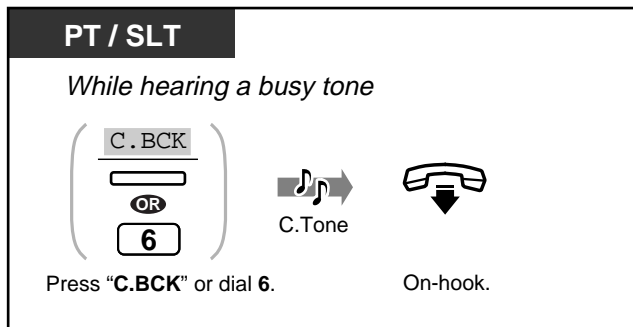

To answer and call

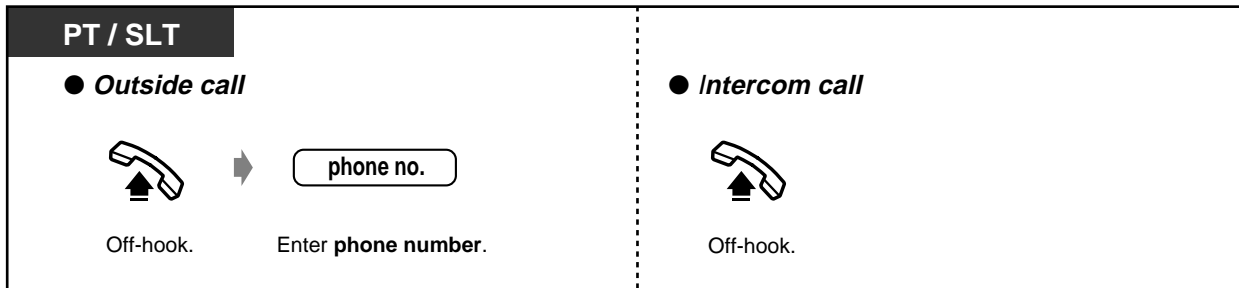

To cancel

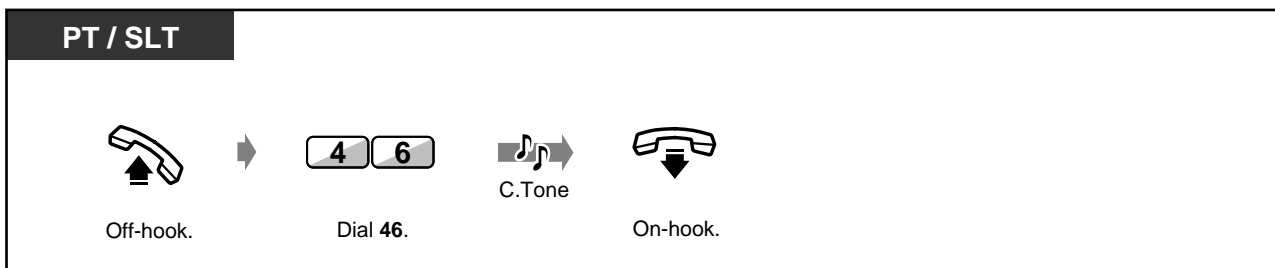



- If you do not answer after four call-back rings, this feature will be cancelled.
- This feature is not available for an ISDN telephone user.



- If you connect to an ISDN line, the busy party will automatically be dialed. "CCBS" will be displayed instead of "C.BCK". Refer to "Completing a call to a busy party on an ISDN line".

◆◆ **Completing a call to a busy party on an ISDN line (Completion of Calls to Busy Subscriber [CCBS])**

You can set the telephone to receive call-back ringing when a busy called party on an ISDN line becomes free. When you answer the call-back ringing, the called party's telephone number is automatically dialed.

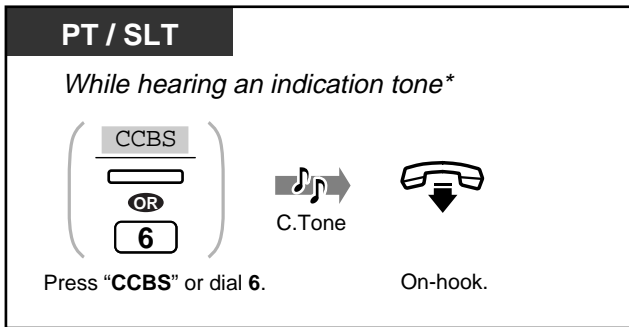

◆ **To answer and call**



◆ **To cancel**

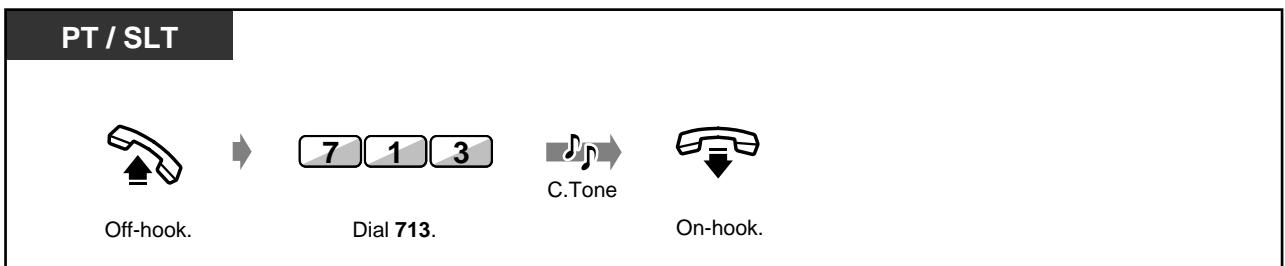

Making Calls



- If you do not answer after four call-back rings, this feature will be cancelled.
- This feature is not available for an ISDN telephone user.
- *Indication tone



- Availability of this feature depends on the ISDN service of your telephone company.



◆◆ Sending a call waiting tone (Busy Station Signalling [BSS])

The party will know your call is waiting.

PT / SLT

While hearing a busy tone

BSS

OR

2

Press "BSS" or dial 2.



- If **"BSS" is not displayed or you hear a reorder tone**, this feature is not set at the other party's phone. This feature is only available if the called extension has set the "Call Waiting" feature.
- **Depending on the other party's telephone**, the "Off-Hook Call Announcement (OHCA)" and the "Whisper OHCA" functions can be applied. You can talk to the other party through the speaker and the microphone (OHCA) or you only send a call announcement through the handset (Whisper OHCA), while they are having another conversation using the handset.
- This feature is not available for an ISDN telephone user.



◆◆ Leaving a message waiting indication (Message Waiting)

The called extension receives a message waiting indication (MESSAGE button light turns on and / or indication tone* is emitted when going off-hook) to call you back.

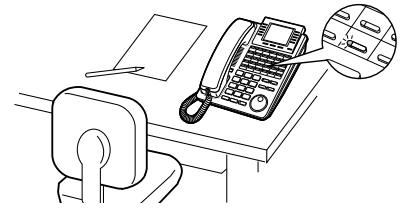

◆ To leave a message waiting indication

PT

When the called extension is busy or does not answer

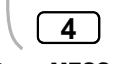
 **OR** 

Press **MESSAGE** or dial **4**.

 C.Tone

 On-hook.

◆ To leave / cancel a message waiting indication

PT / SLT

 Off-hook.

→  Dial **70**.

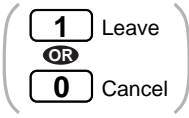
→  Dial **1** to leave or **0** to cancel.

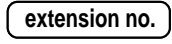
→  Enter **extension number**.

→  C.Tone

→  On-hook.

T7431

 Press **MODE** until "Feature Access" is displayed.

→  Rotate **Jog Dial** until "MSG Off" or "MSG On" is displayed.

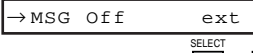
→  Press **SELECT**. "MSG On": Leave "MSG Off": Cancel.

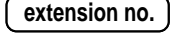
→  Enter **extension number**.

→  C.Tone

→  On-hook.

T7433

 Press **SHIFT** until "FEAT" is displayed.

→  Press "FEAT".

→  Rotate **Jog Dial** until "MSG Off" or "MSG On" is at the arrow.

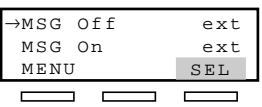
→  Press "SEL". "MSG On": Leave "MSG Off": Cancel

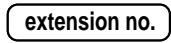
→  Enter **extension number**.

→  C.Tone

→  On-hook.

Making Calls

◆ To leave / cancel a message waiting indication (contd.)

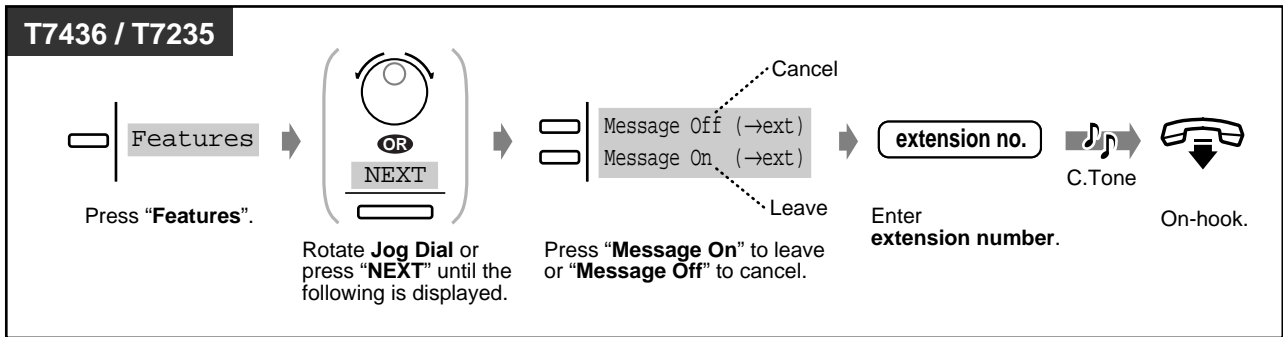

◆ To check and select the party

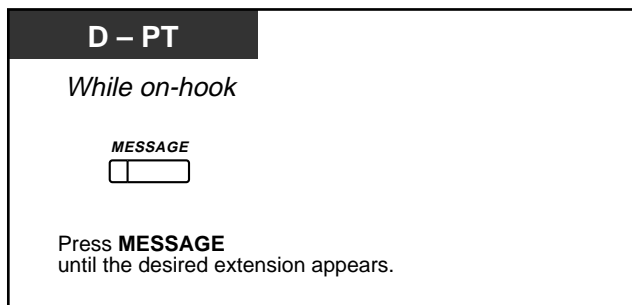

- The extension number and name are shown in the received order.
- Single line telephone users may hear a special ring tone as notification while on-hook, if required.
- This feature is not available for an ISDN telephone user.
- * Indication tone



◆ To call back

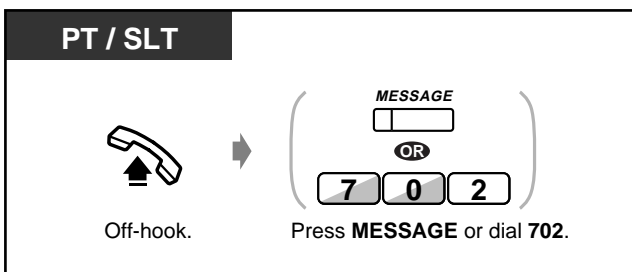



◆ **To clear all message waiting indications**

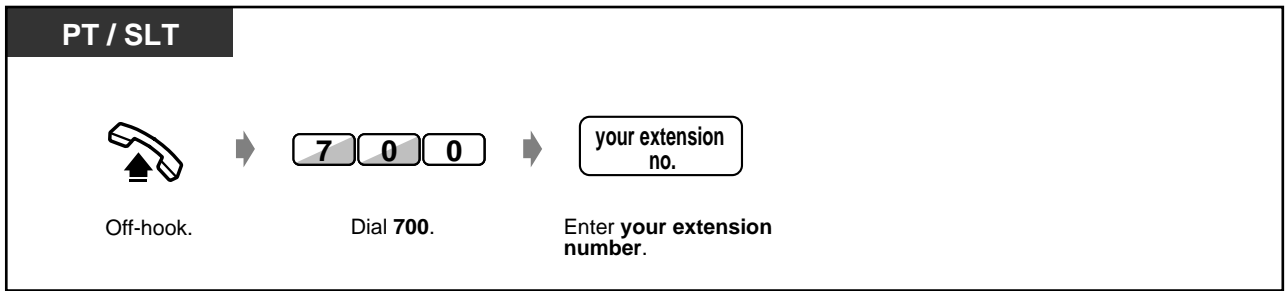

Customising Your Phone

• **Customising the Buttons**

Create or re-arrange a MESSAGE button.

Making Calls

Calling without Restrictions

- Using an account code
- Changing the dialling mode
- To an extension refusing the call

◆◆ Using an account code (Account Code Entry)

An Account Code gives information about outside calls for accounting and billing purposes. You may not be able to make an outside call without an account code entry. A mode is assigned to each user. Ask your manager for your mode.

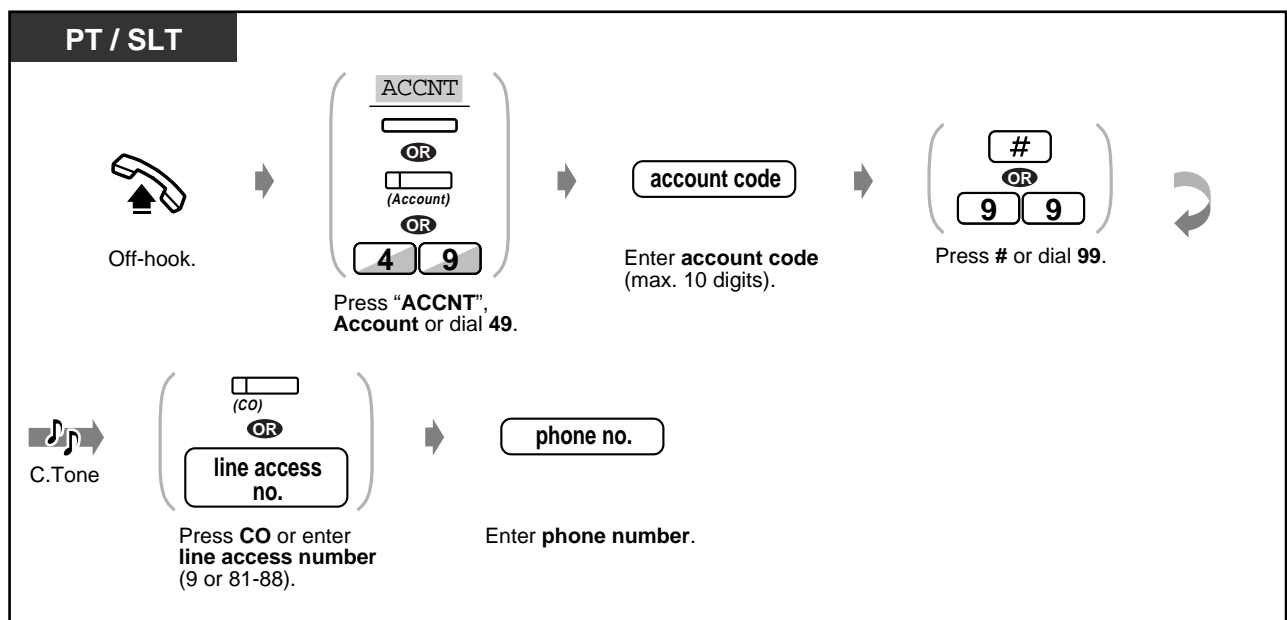

- A Panasonic proprietary telephone user can enter an account code during a conversation and when hearing a reorder tone after the other party hangs up.
- If you enter the wrong code, press the "×" key while entering the account code and then re-enter the code.
- To cancel the entry, press the Account button while entering the code.
- For your convenience, you can store the code with the phone number in memory (e.g. Speed dialling).
- If you hear a reorder tone, the entered account code is wrong. Enter the correct code.



- You may give a specified account code to extension users and check their telephone usage. You can specify an account code to each client and check the call duration.



Customising Your Phone

- Customising the Buttons
Create or re-arrange an Account button.



◆◆ To an extension refusing the call (DND Override)

PT / SLT

While hearing the DND tone

Over

OR

2

Press "Over" or dial 2.



- This feature is not available for an ISDN telephone user.

◆◆ Changing the dialling mode (Pulse to Tone Conversion)

To access services such as computer telephone services, Voice Mail, etc., that require a tone, you can temporarily change the dialling mode from Pulse to Tone.

PT / SLT

After the line is connected

*# → desired no.

Dial *#. Enter **desired number**.

Making Calls

Alternating the Calling Method (Alternate Calling — Ring / Voice)

The calling method, either ring or voice, is set by the called extension when an intercom call is received. However, you can change the method temporarily. With Voice-Calling, you can talk to the party as soon as the line is connected. (Default: Ring-Calling)

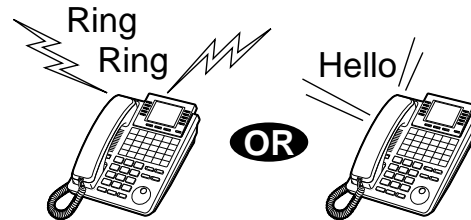

◆ For voice-calling

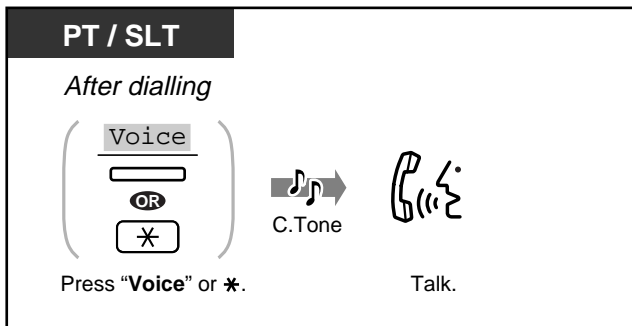

◆ For ring-calling

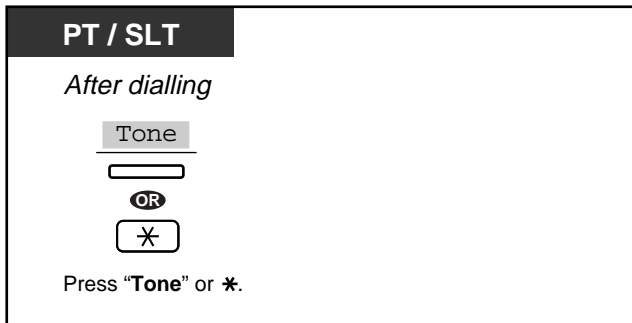

- If the called party uses a single line telephone, only Ring-Calling is available.



Customising Your Phone

• Initial Settings – Intercom Alert Assignment

Which way do you prefer to receive an intercom call?

Receiving Calls

Answering Calls

PT / SLT



Off-hook. Talk.

Select one of the following methods:

- Lift the handset to receive the preferred line. (Default: Ringing line is selected.)
- Press the SP-PHONE button.
- Press the flashing red CO or green INTERCOM button directly.

Customising Your Phone

- **Initial Settings – Preferred Line Assignment – Incoming**
Select the seized line when going off hook.
- **Intercom Alert Assignment**
Select the Calling method, either ring or the other party's voice.
- **Customising the Buttons**
Re-arrange the CO button and change the ringing tone for each CO button.



• Hands-free operation

You can have a conversation in the hands-free mode with the SP-PHONE button. You can perform other tasks at the same time.

Helpful hints for the hands-free operation

- Use your telephone in a quiet room for best performance.
- If the other party has difficulty hearing you, decrease the volume.
- If you and the other party talk at the same time, parts of your conversation will be lost. To avoid this, talk alternately.

- **If the Caller ID feature is available**, you may confirm the caller's phone number and name before answering an outside call. Pressing the SHIFT button displays the outside line number and name.

<Example>

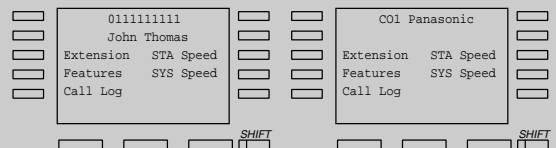

The caller's information from your telephone company will only be sent to the pre-assigned extension.

Receiving Calls

Answering Hands-free (Hands-free Answerback)

You can answer an intercom call without going off-hook as soon as the line is connected.
You will hear the caller talking without the phone ringing.



◆ **To set / cancel**

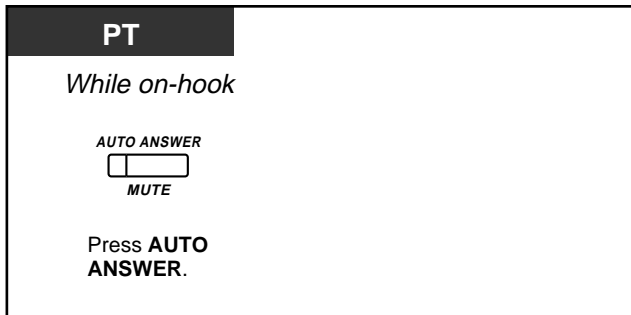

- The AUTO ANSWER button light shows the current status as follows:
On: Set.
Off: Not set.



Answering a Call Ringing at Another Telephone (Call Pickup)

You can answer an incoming call that is ringing at another extension from your phone without leaving your desk.

The following types are available:

- Outside (CO) Call Pickup:** Picks up an outside call.
- Group Call Pickup:** Picks up a call within your extension group.
- Directed Call Pickup:** Picks up a specified extension's call.

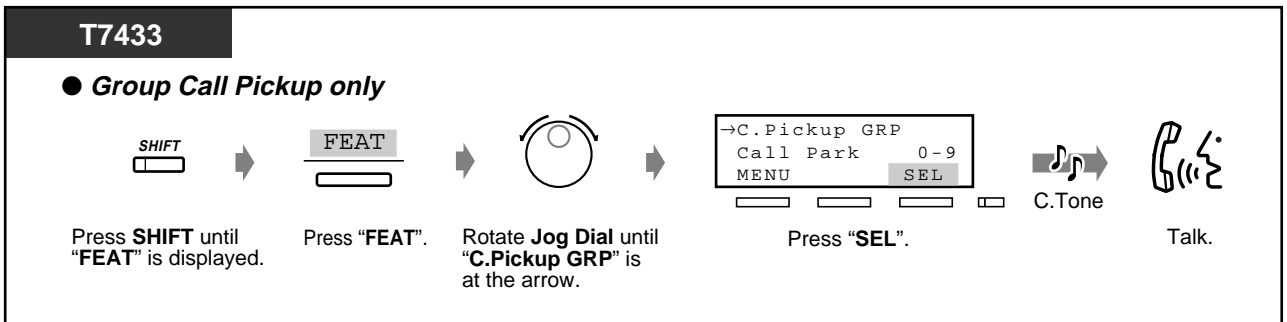
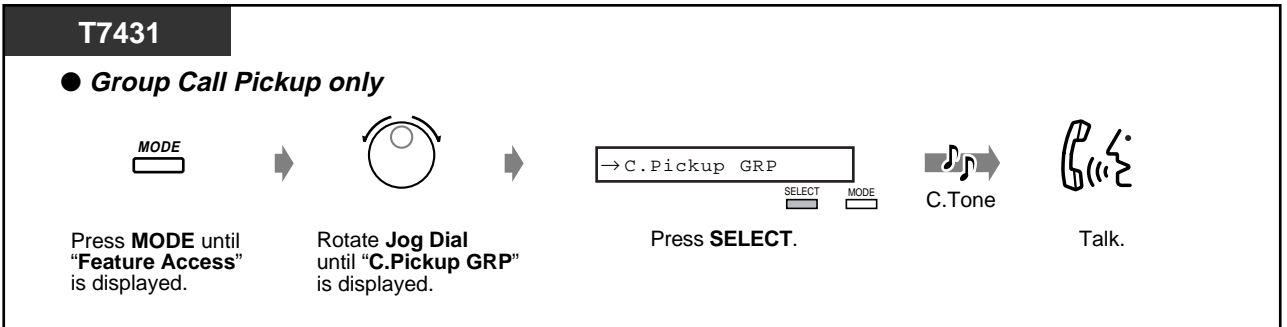
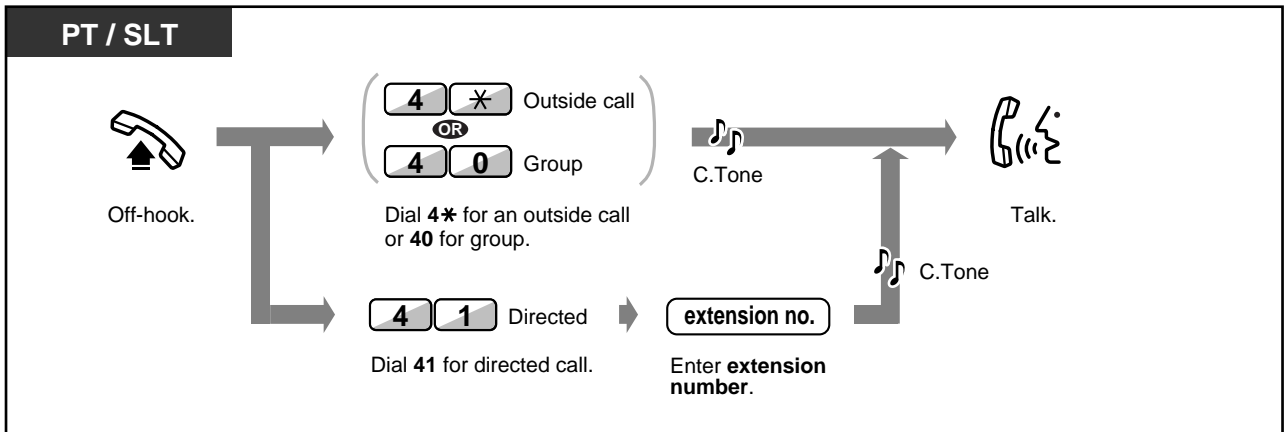

Receiving Calls

T7436 / T7235

● Group Call Pickup only

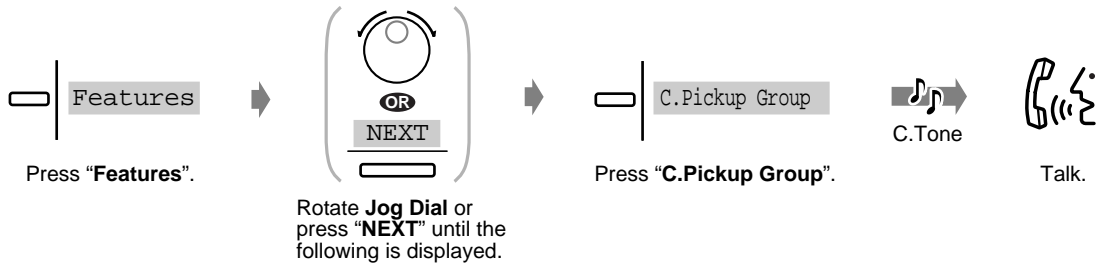

- If you receive a call waiting tone, you can ask a third party to pick up your second call with Directed Call Pickup.
- "Group Call Pickup" is not available for an ISDN telephone user.



- You can also deny other people the possibility of picking up your calls. Refer to "Setting the Telephone According to Your Needs".

Answering a Call via an External Speaker

(Trunk Answer From Any Station [TAFAS])

You can answer an incoming outside call paged through an external speaker from any extension.

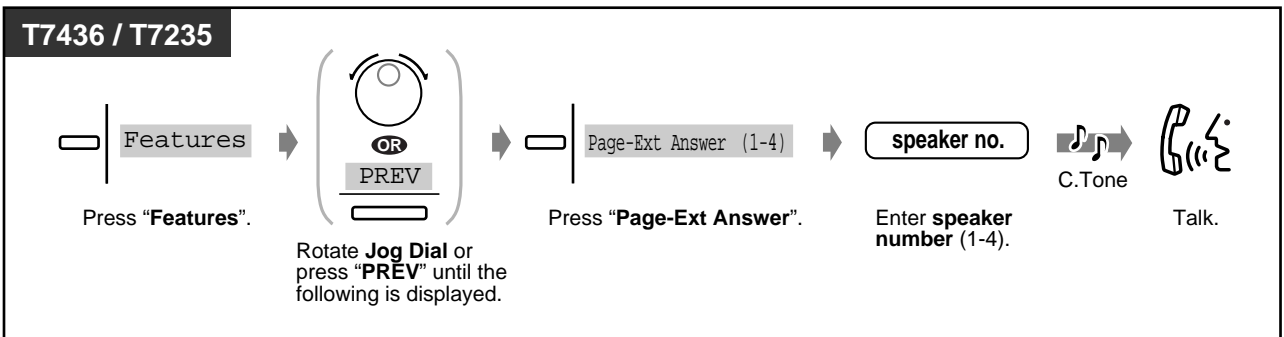
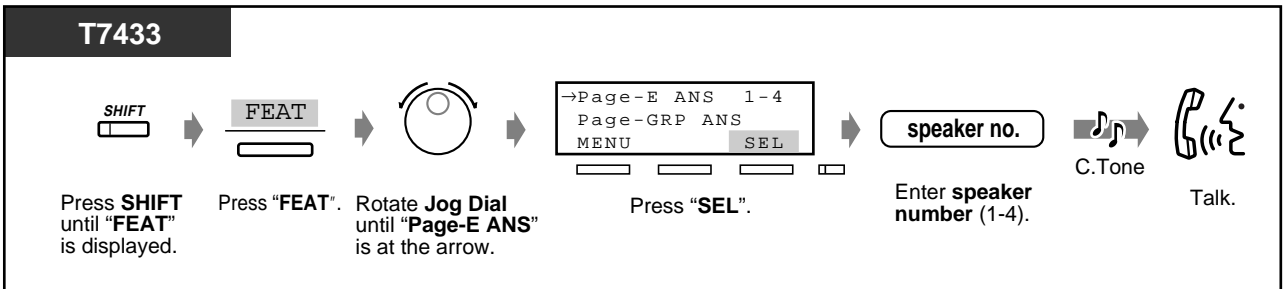
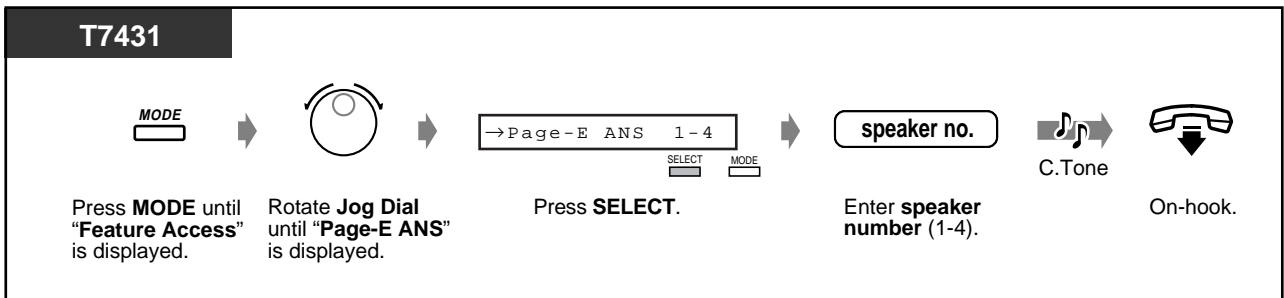
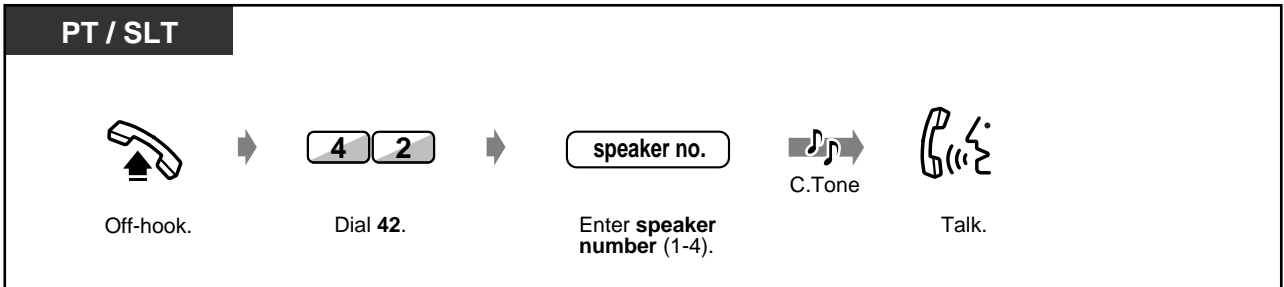

!!

- You can also receive a paged announcement via a speaker with this operation.

During a Conversation

Holding a Call

- Holding
- Denying other people the possibility of retrieving your held calls
- Holding in a system parking zone



- If a call is not retrieved within a specified time, you will hear an alarm as a reminder.
- If a call is not retrieved within fifteen minutes, it is automatically disconnected.

Holding (regular)

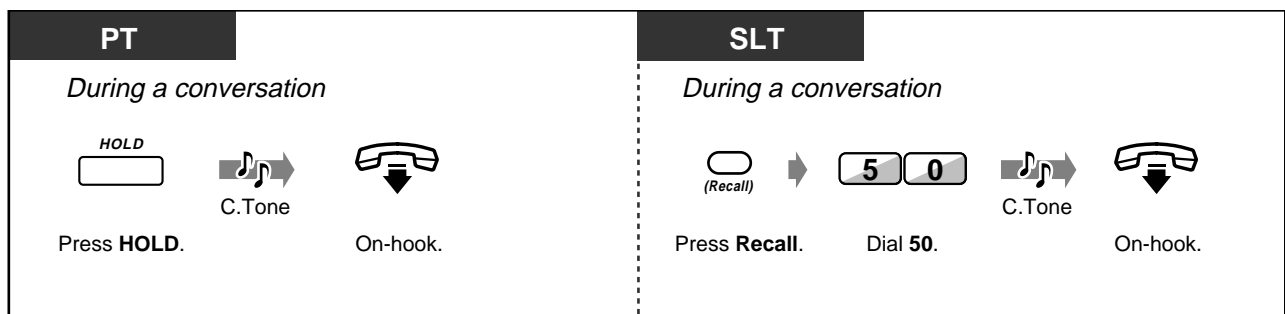

To retrieve a call

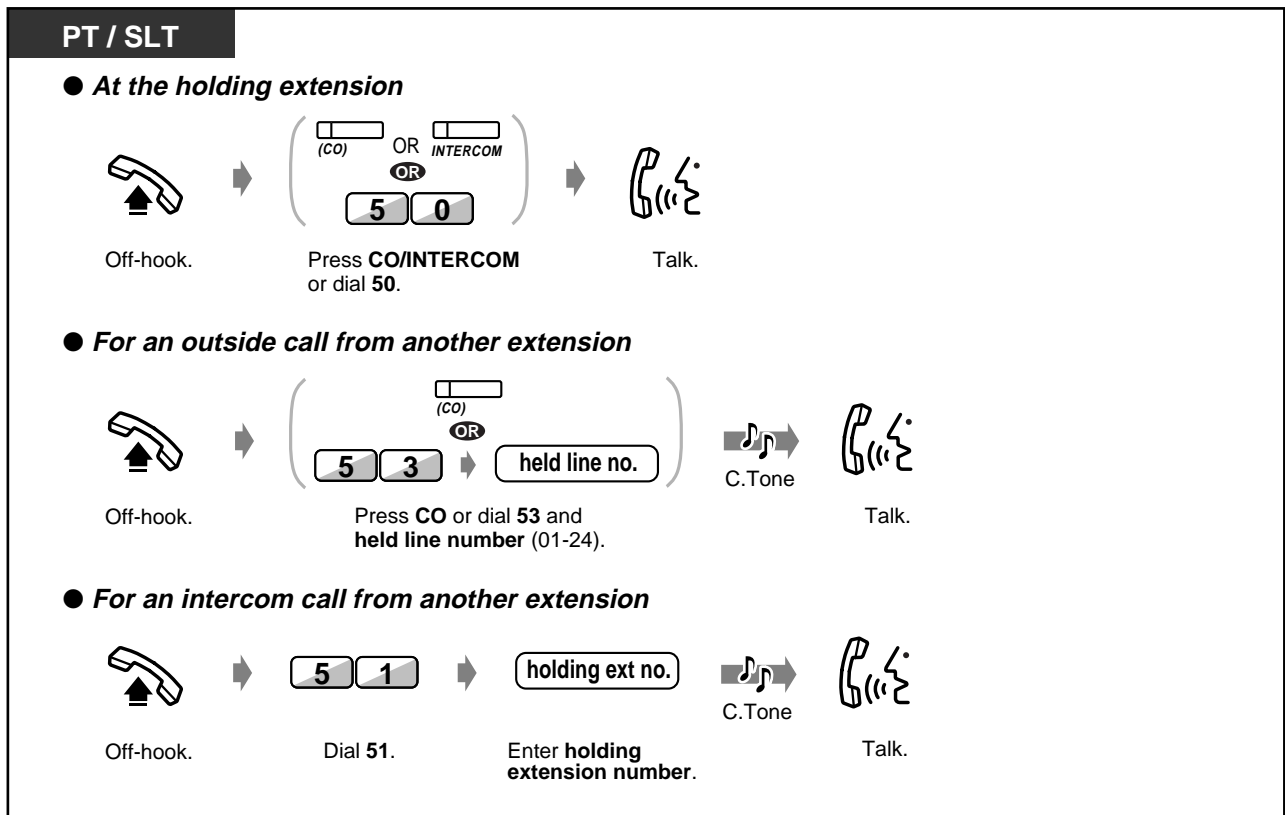



• The CO or INTERCOM button light shows the current status as follows:

Flashing green: Your held call

Flashing red: Another extension's held call

- A single line telephone user can hold either an intercom call or an outside call at one time.
- A proprietary telephone user can hold an intercom call and multiple outside calls.
- **To hold multiple intercom calls,** use the "Call Park" feature.
- This feature is not available for an ISDN telephone user.

◆◆ Denying other people the possibility of retrieving your held calls (*Exclusive Call Hold*)

Only the held extension can retrieve the call.

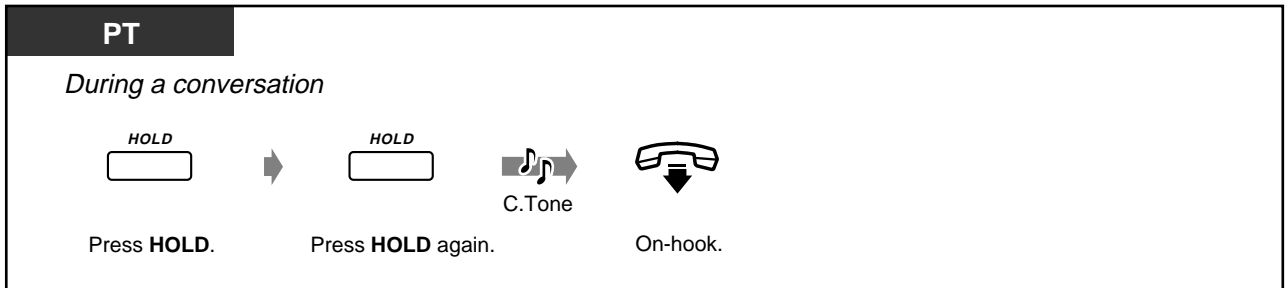

◆ To retrieve a call

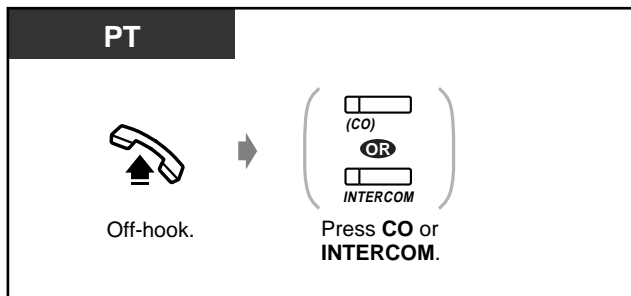

• You can hold an intercom call and multiple outside calls.

During a Conversation

◆◆ Holding in a system parking zone (Call Park)

You can park a call and perform other operations. The parked call can be retrieved by any extension. Up to ten calls can be parked.

◆ To set

PT

During a conversation

Press **TRANSFER**. Dial **52**. Enter **parking zone number** (0-9). C.Tone On-hook.

SLT

During a conversation

Press **Recall**. Dial **52**. Enter **parking zone number** (0-9). C.Tone On-hook.

T7431

During a conversation

Press **TRANSFER**. Press **MODE** until "Feature Access" is displayed. Rotate **Jog Dial** until "Call Park" is displayed. Press **SELECT**. Enter **parking zone number** (0-9). C.Tone On-hook.



◆ To set (contd.)

T7433

During a conversation

Press **TRANSFER**.

Press **SHIFT** until "FEAT" is displayed.

Press "FEAT".

Rotate **Jog Dial** until "Call Park" is at the arrow.

Press "SEL".

Enter **parking zone number** (0-9).

C.Tone

On-hook.

T7436 / T7235

During a conversation

Press **TRANSFER**.

Press "Features".

Rotate **Jog Dial** or press "NEXT" until the following is displayed.

Press "Call Park".

Enter **parking zone number** (0-9).

C.Tone

On-hook.

During a Conversation

◆ To retrieve

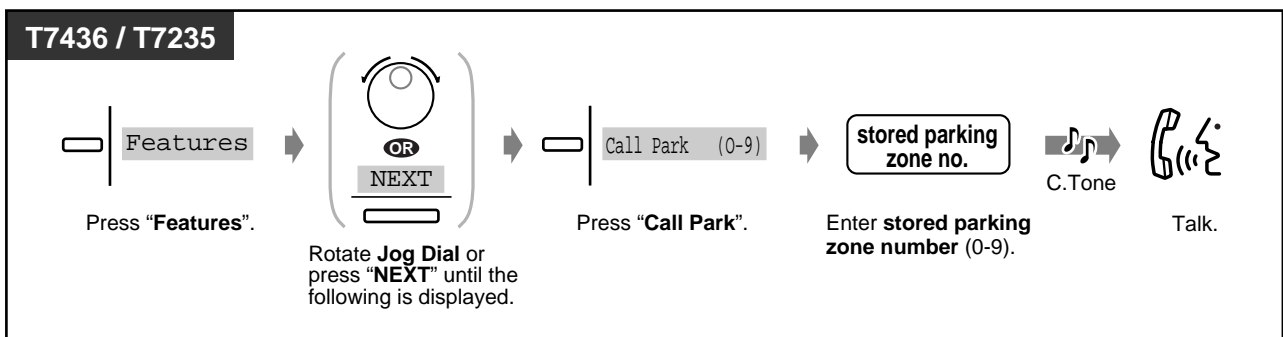
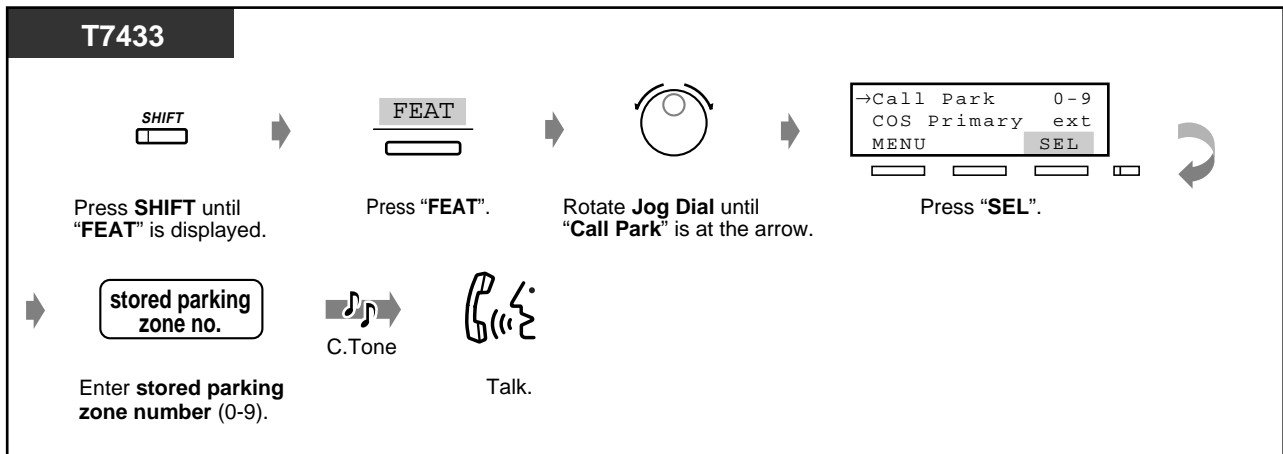
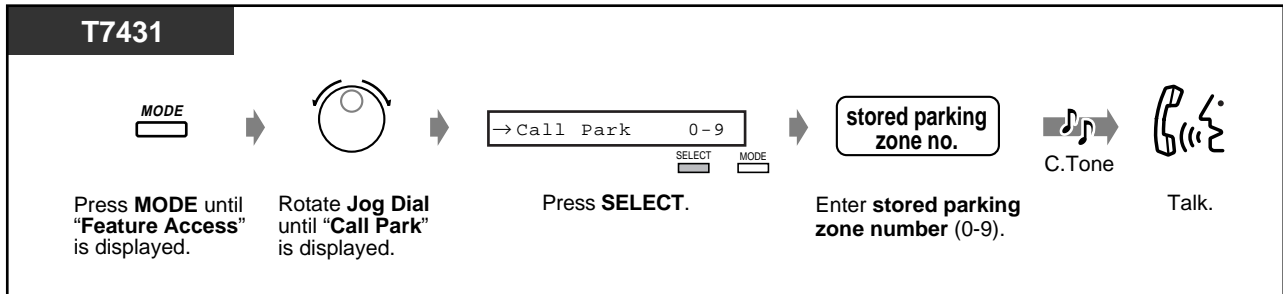
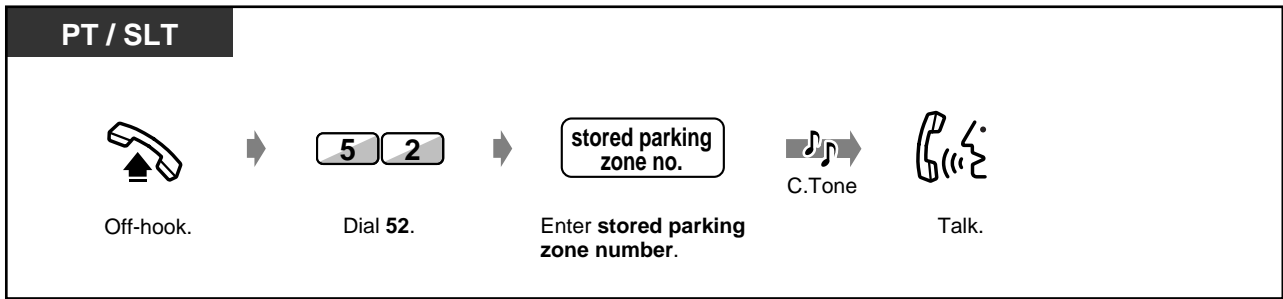





• This function is not available for an ISDN telephone user.



• If you hear a busy tone when entering the zone number, the zone is in use. Enter another number.



Talking to Two Parties Alternately (Call Splitting)

PT	
<p><i>When either party is an outside party</i></p> <p> (CO)</p> <p> OR</p> <p> INTERCOM</p> <p>Press CO or INTERCOM.</p>	<p><i>When both parties are an extension party</i></p> <p> HOLD</p> <p>Press HOLD.</p>

SLT
<p><i>During a conversation</i></p> <p> (Recall)</p> <p>Press Recall.</p>

During a Conversation

Transferring a Call

– Transferring to an extension

– Transferring to an external party

◆◆ Transferring to an extension

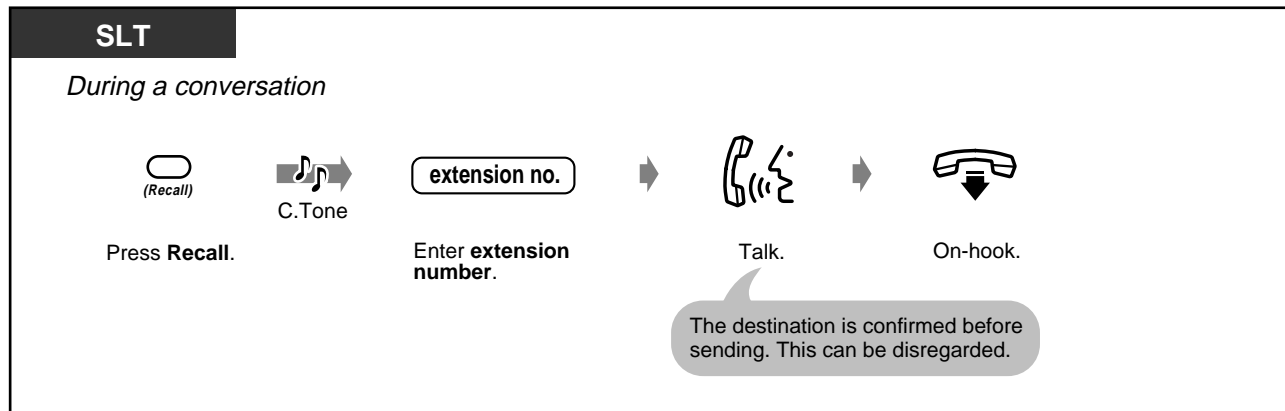
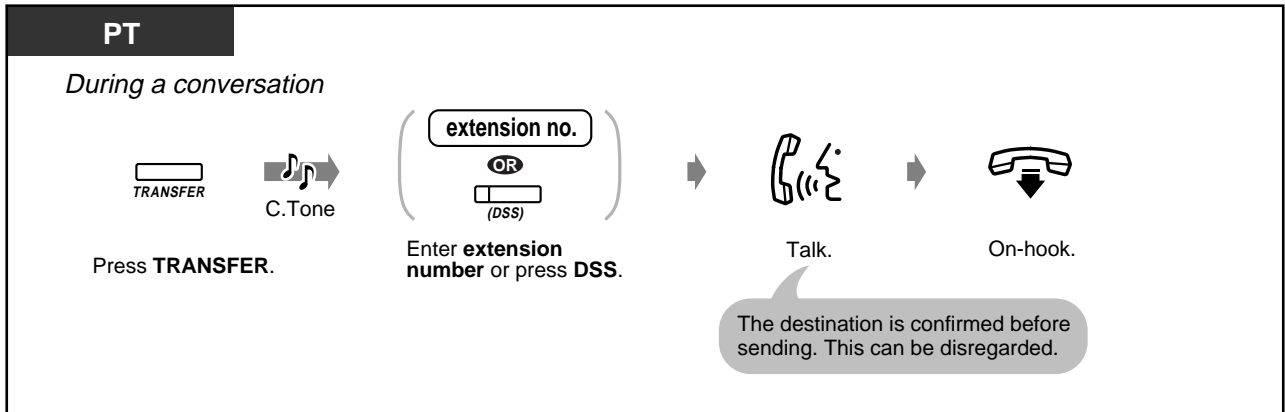



◆◆ Transferring to an external party

Some extensions may be restricted from performing this function.

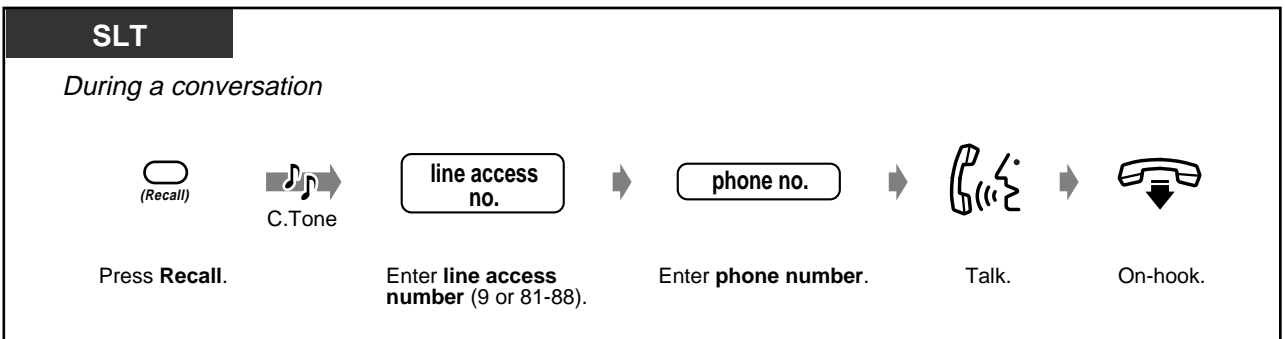
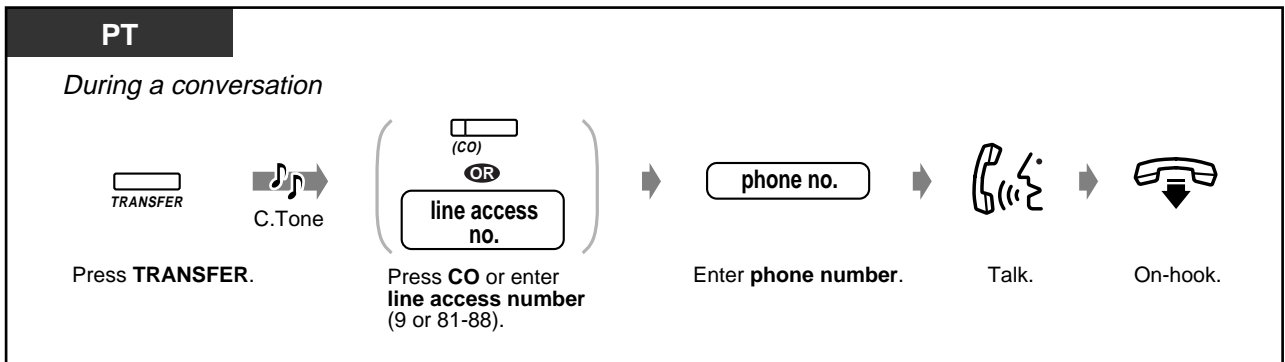

- **If you misdial**, press the FLASH/RCL (PT only) button, and re-enter the number.
- **To return to the held call**, press the TRANSFER button, corresponding CO, INTERCOM button, or the Recall (SLT only), before the destination answers.
- **To return to the conversation**, press the corresponding CO button.
- **If you hear an alert tone**, the destination extension did not answer the call. Answer the call.
- This feature is not available for an ISDN telephone user.



- **If you transfer a call with the DSS or One-Touch Dialling with Auto Hold button**, you do not have to press the Transfer button (One-Touch Transfer).



Customising Your Phone

• Customising the Buttons

Create or re-arrange a DSS and One-Touch Dialling with Auto Hold button.

During a Conversation

Answering a Call Waiting

During a conversation, a call waiting tone or voice announcement through the speaker or the handset occurs when an outside call is received or another extension is letting you know another call is waiting. To activate this feature, set to “On”. (Default: No tone) You can answer the second call by disconnecting the current call or placing it on hold.

◆ To talk to the new party

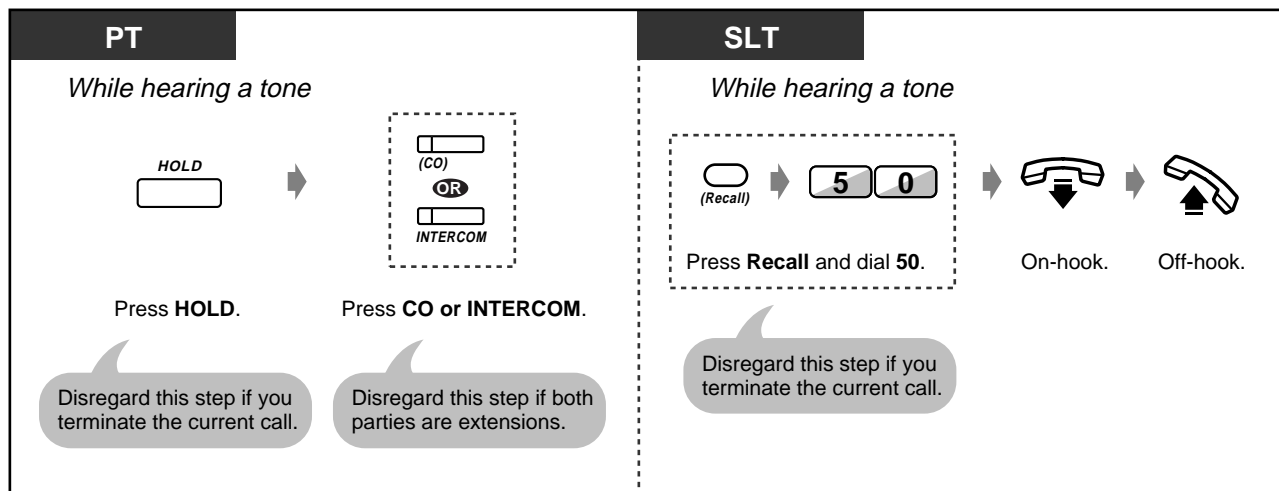

- Depending on the other party's telephone, the "Off-Hook Call Announcement (OHCA)" and the "Whisper OHCA" functions can be applied. You can talk to the other party through the speaker and the microphone (OHCA) or you only receive a call announcement through the handset (Whisper OHCA), while they are having another conversation using the handset.
- The calling extension's name or number is displayed for five seconds in ten second intervals before answering a call.
- This feature is not available for an ISDN telephone user.



Customising Your Phone

• Initial Setting – Call Waiting Tone Type Selection

Determine the tone depending on the second party, either an outside call or an extension.

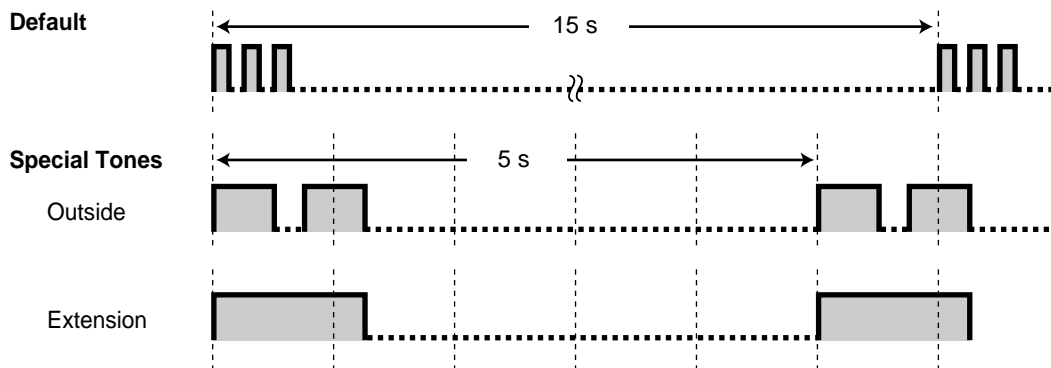



Three-party Conversation

- Adding a third party during a conversation
- Leaving a conference

◆◆ Adding a third party during a conversation (Conference)

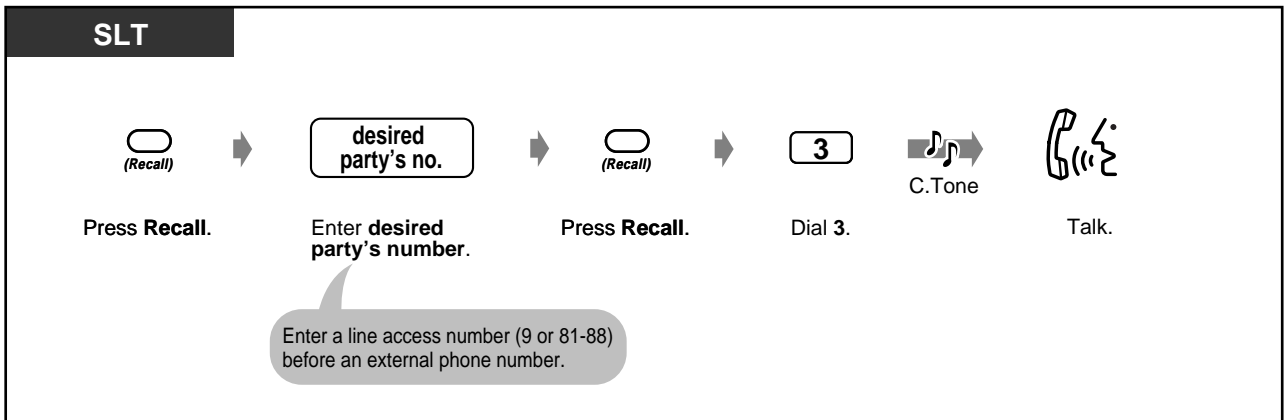
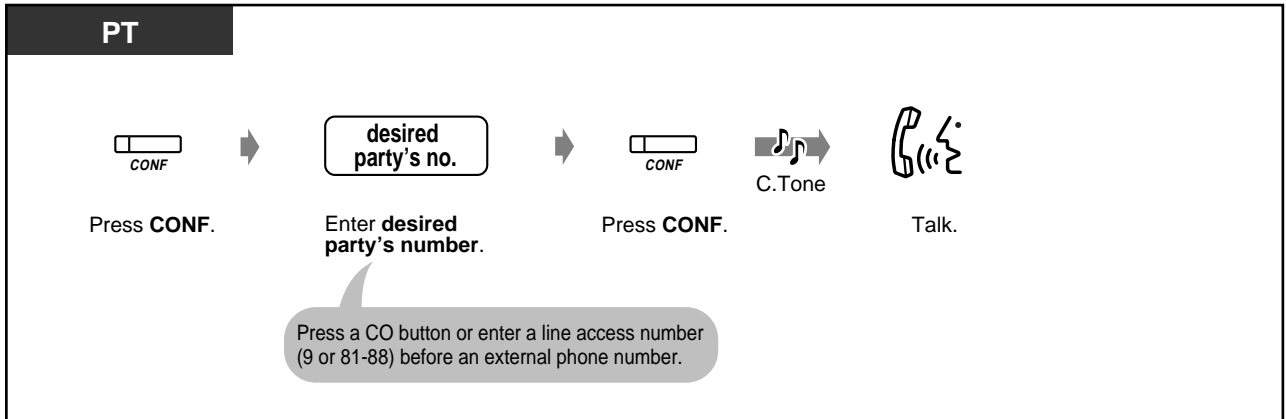

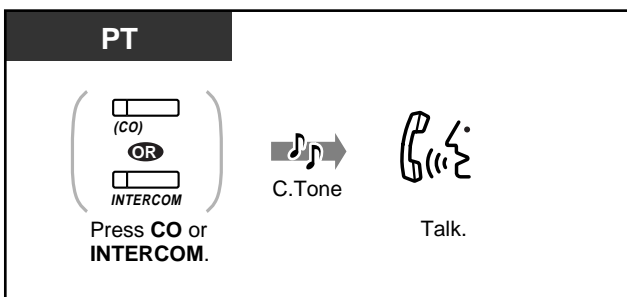

◆ To talk to one party by disconnecting the other when one of these parties is an outside call



During a Conversation

◆◆ Leaving a conference

The other two parties can continue their conversation.

PT / SLT	PT
<p><i>When you are talking with two extensions or one extension party and one external party</i></p>  <p>On-hook.</p>	<p><i>When you are talking with two external parties (Unattended Conference)</i></p>  <p>Press CONF.</p> <div data-bbox="974 472 1372 556" style="border: 1px solid gray; border-radius: 15px; padding: 5px; background-color: #e0e0e0;"><p>Some extensions may be restricted from performing this function.</p></div>

◆ To return

PT
<p><i>While the others are talking</i></p>  <p>Press CO.</p>



• This feature is not available for an ISDN telephone user.



Customising Your Phone

• Customising the Buttons

Create or re-arrange a Conference button.



Saving a Number (Notebook Function)

You can store a desired outside phone number in memory during a conversation or while on-hook. You can dial the stored number easily.



◆ To store

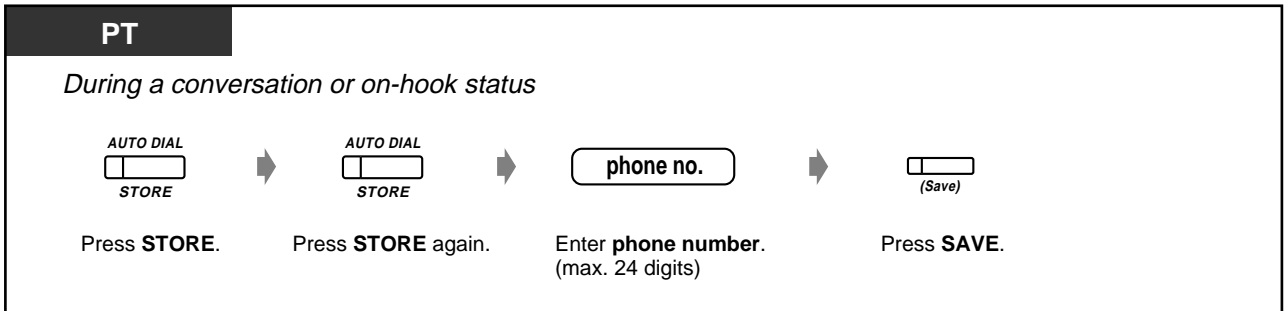

◆ To dial



- You do not have to store a line access number before the phone number. An outside line is automatically accessed.
- “*” and “#” can also be stored as a digit.



Customising Your Phone

- **Customising the Buttons**
Create or re-arrange a SAVE button.

During a Conversation

Mute

You can disable the microphone or the handset to consult privately with others in the room while listening to the other party on the phone through the speaker or the handset.



There are two types of mute as follows:

Handset Mute: During a conversation using the handset.
This function is available for the KX-T7400 series telephone users only.

Microphone Mute: During a conversation using the microphone.

◆ To set / cancel

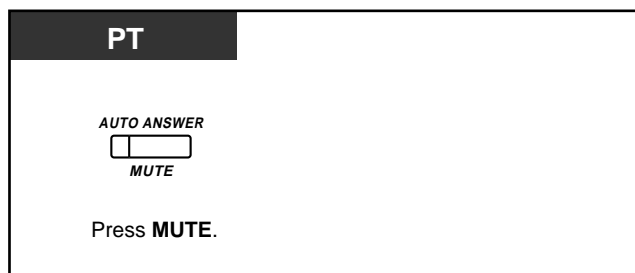

- The AUTO ANSWER/MUTE button light shows the current status as follows:

Flashing red: Mute

Off: Normal

Letting Other People Listen to the Conversation (Off-Hook Monitor) [KX-T7400 series telephone only]

You can let other people in the room listen to the conversation through the speaker while continuing the conversation using the handset.



◆ **To set / cancel**



- This feature is only available during a conversation using the handset.
- The SP-PHONE button light shows the current status as follows:
 - On:** The voice is heard through the speaker.
 - Off:** The voice is heard through the handset.

Before Leaving Your Desk

Forwarding Your Calls (Call Forwarding)

You can have your incoming calls forwarded to a specific destination. Internal destination may be an extension or a receiving group.

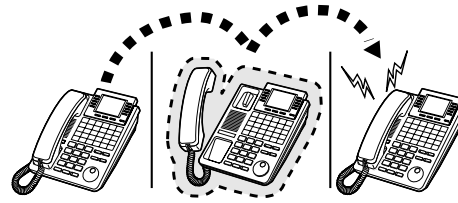

All Calls: All calls are forwarded to another internal destination.

Busy: All calls are forwarded to another internal destination when your extension is busy.

No Answer:

All calls are forwarded to another internal destination when you do not answer the call.

Busy/No Answer (BSY N/A):

All calls are forwarded to another internal destination when you do not answer or when your extension is busy.

To Outside Line (CO Line):

All calls are forwarded to an external party. Some extensions may be restricted.

Follow Me (From):

If you forget to set "All Calls" to be forwarded before you leave your desk, you can set the same functions from the destination extension.

By ISDN Line:

All calls are forwarded to an external party by ISDN line in one of the following conditions.

- Unconditionally (Call Forwarding Unconditional [CFU])
- When you do not answer (Call Forwarding No Reply [CFNR])
- When your extension is busy (Call Forwarding Busy [CFB])

Some extensions may be restricted.



- You can set your mailbox or mobile telephone as the forwarding destination.



◆ To set (except "Call Forwarding by ISDN Line")

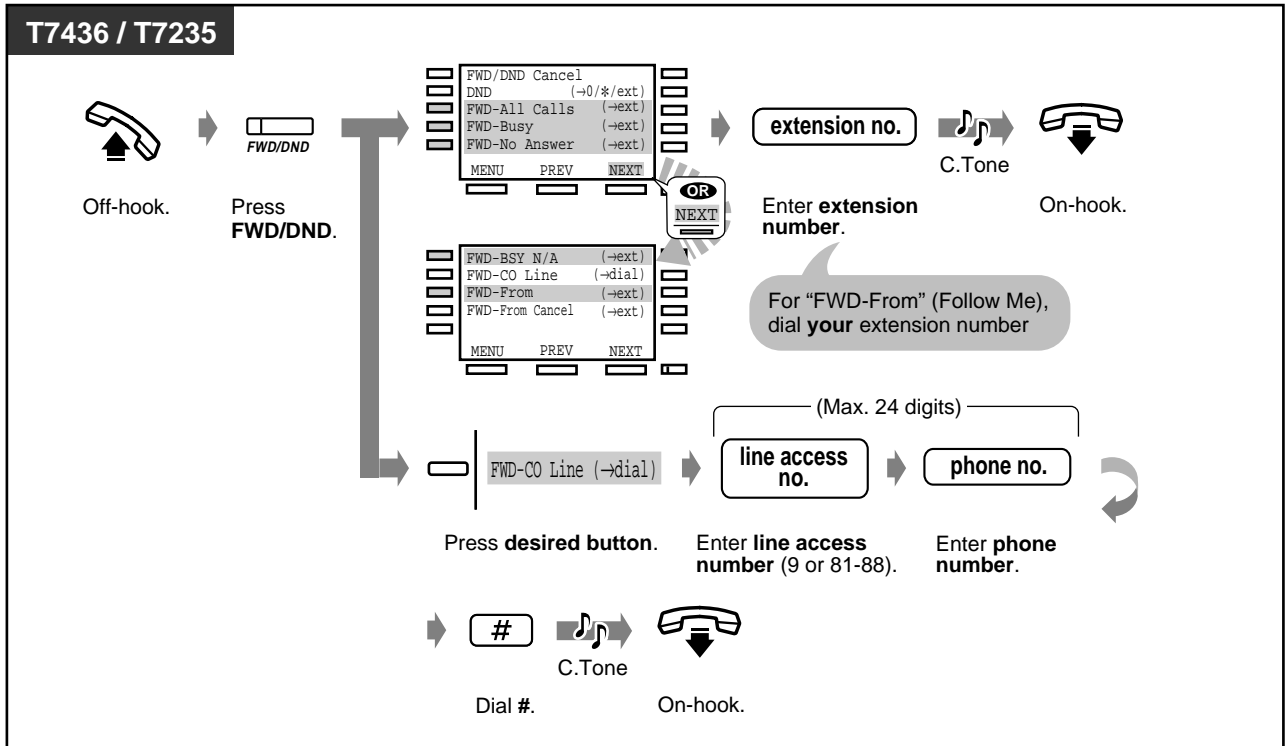
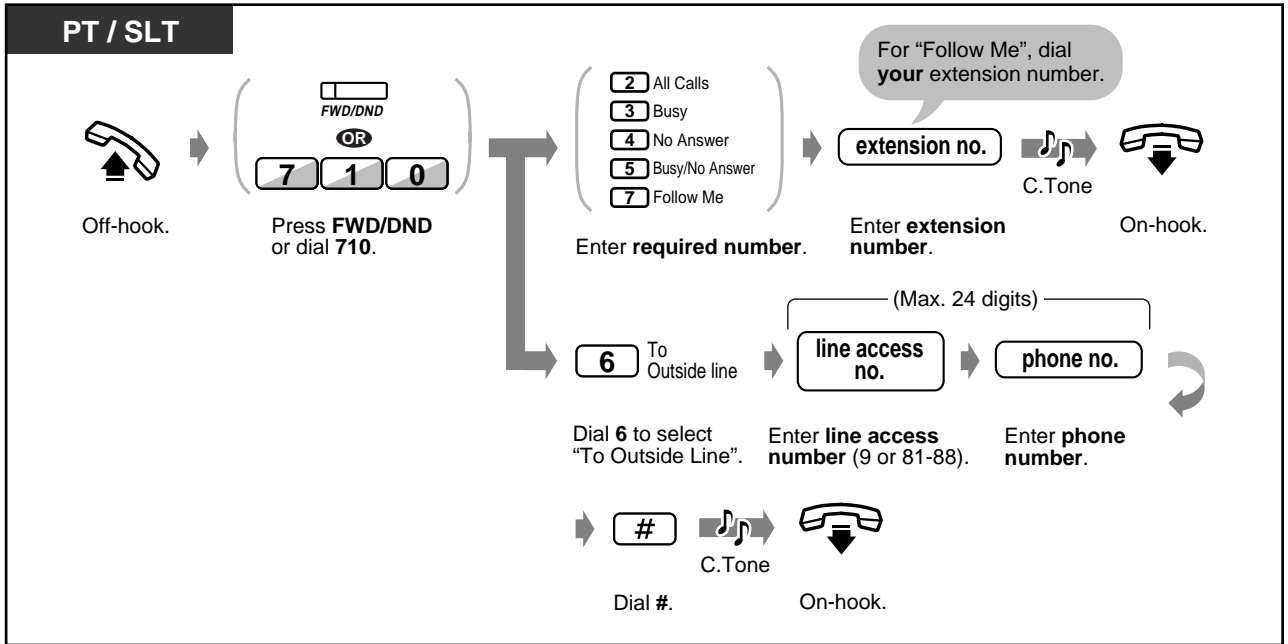

Before Leaving Your Desk

◆ To cancel (except “Call Forwarding by ISDN Line”)

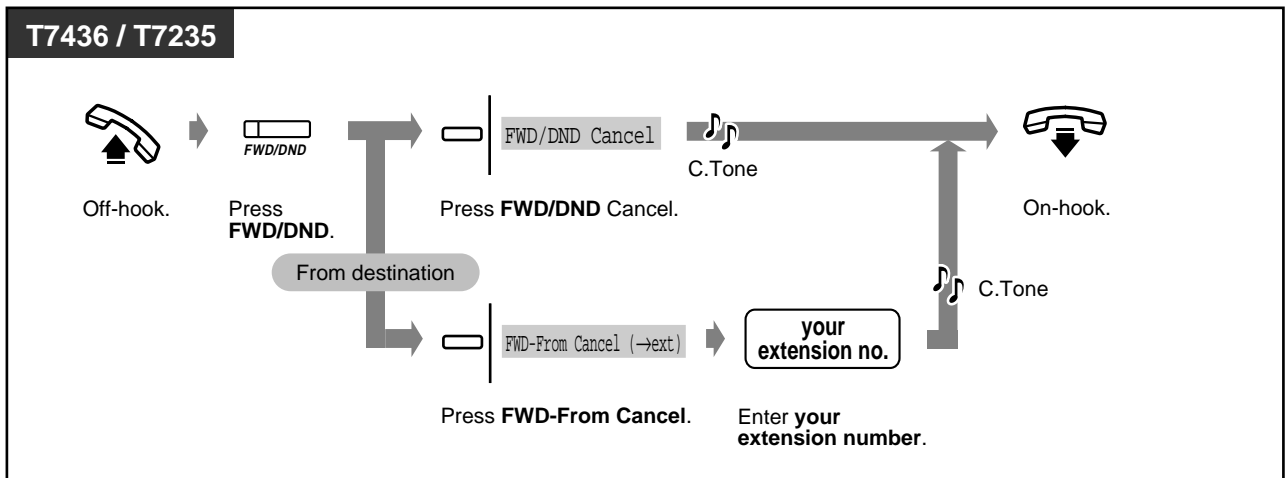
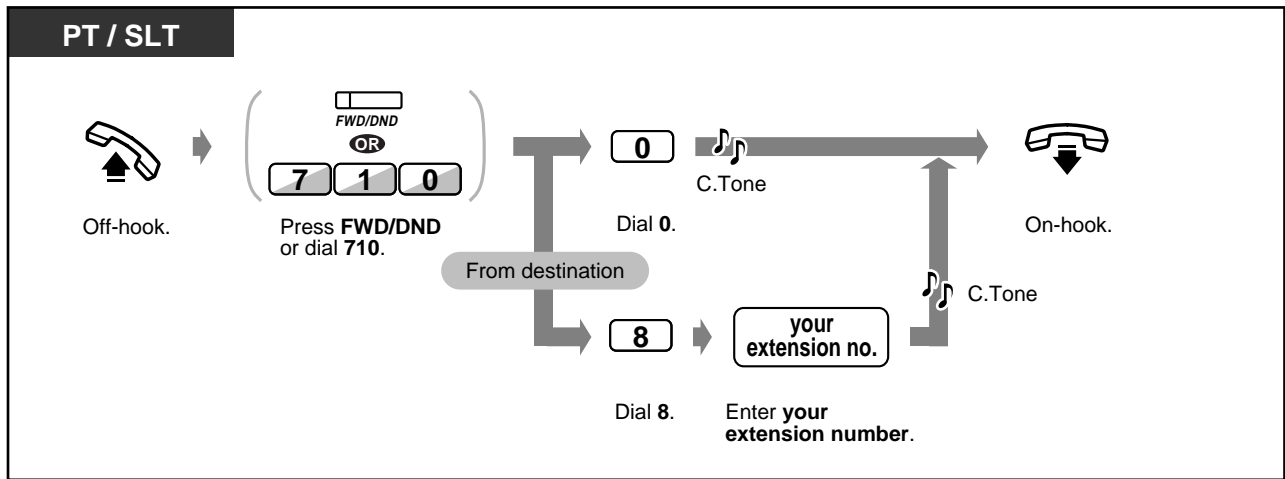

◆ To set “Call Forwarding by ISDN Line”

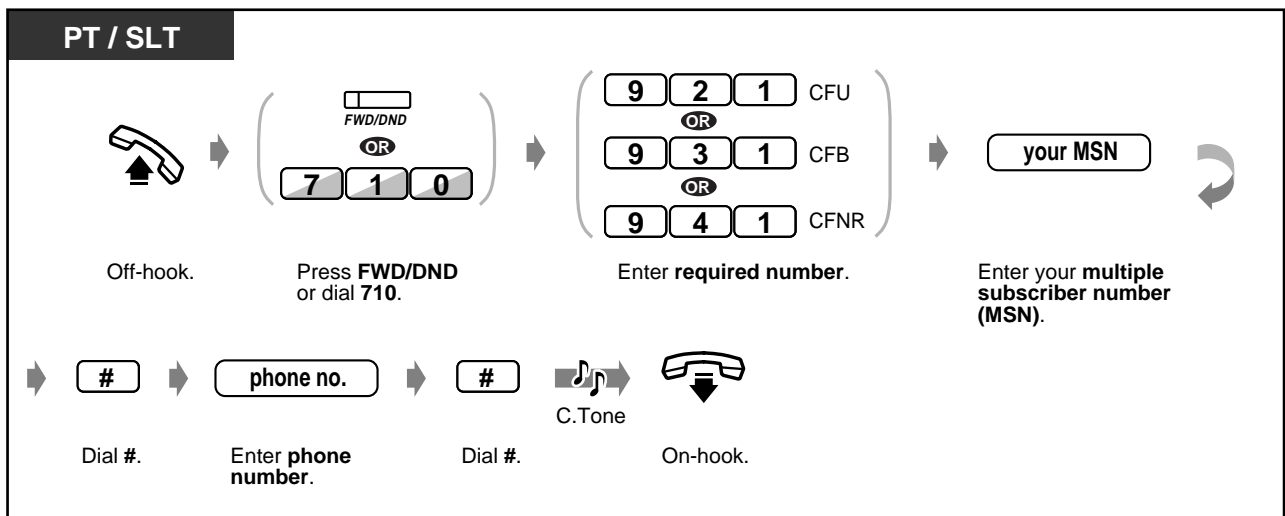



◆ To cancel “Call Forwarding by ISDN Line”

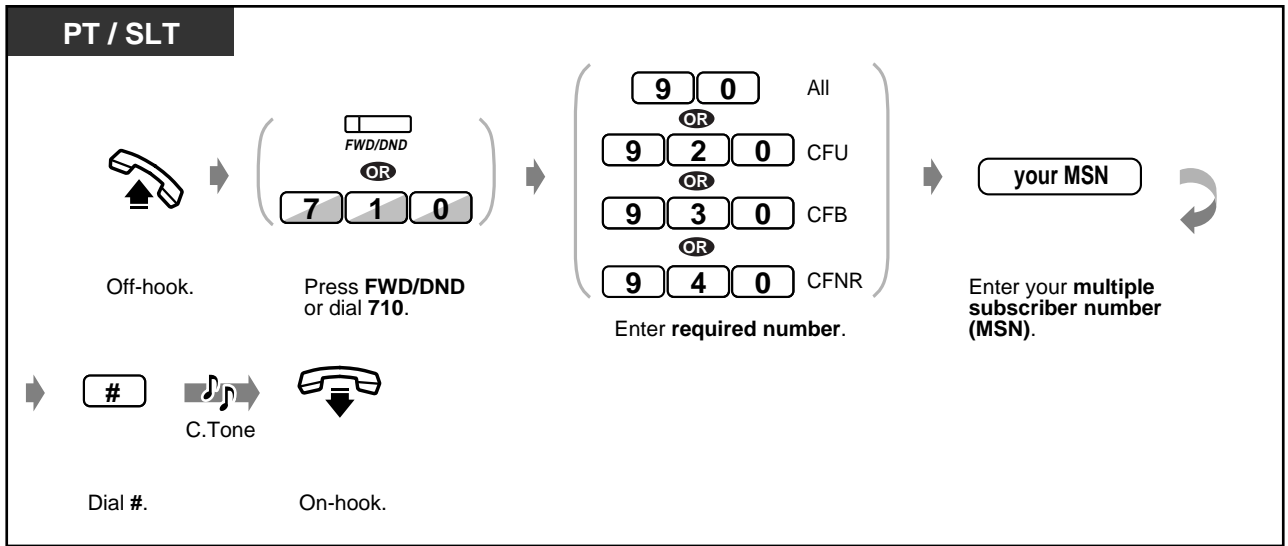

- Each call can be forwarded up to four times. The fifth time will be disregarded.

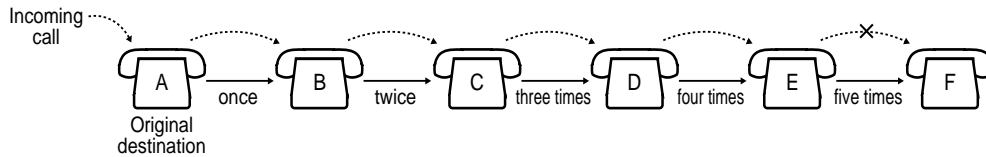

• Boss-Secretary function

The extension which has been set as the destination can call the forwarding extension. Also, any extension in the receiving group which has been set as the forwarded destination can call the forwarding extension.

<Example>

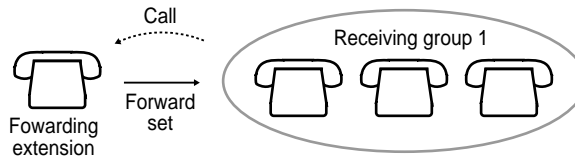

- The FWD/DND button light flashes red when the Call Forwarding feature is set.
- This feature is not available for an ISDN telephone user.



Customising Your Phone

• Customising the Buttons

Create or re-arrange a FWD/DND button.

Before Leaving Your Desk

Forwarding Calls from a Receiving Group (Call Forwarding – from Hunting Group)

Pre-assigned extension users can forward calls arriving at any receiving group or calls arriving just at your own receiving group. The destination can be another receiving group or a specific extension. Some extensions may be restricted.

◆ To set

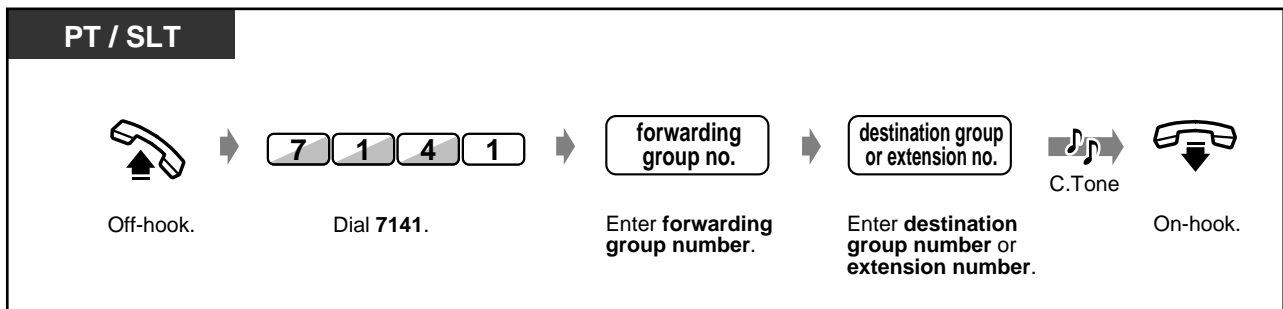

◆ To cancel

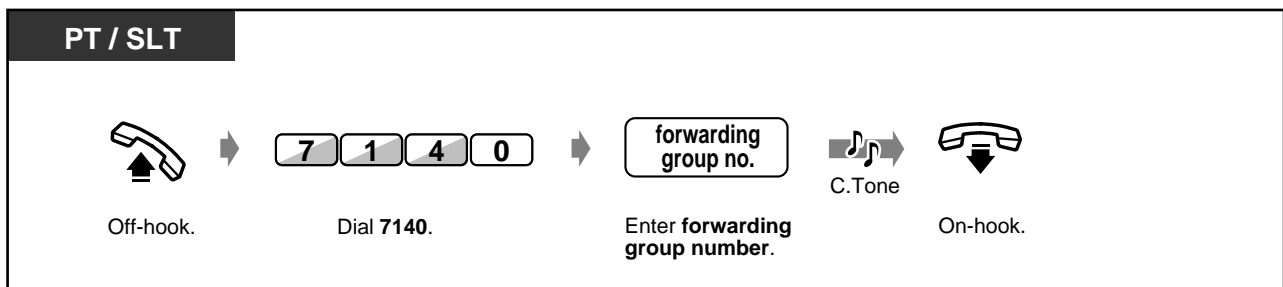

- You can set or cancel this feature by simply pressing the Call Forwarding from Hunting Group button. If set, the button light turns red.
- Each call can be forwarded up to four times. The fifth time will be disregarded.

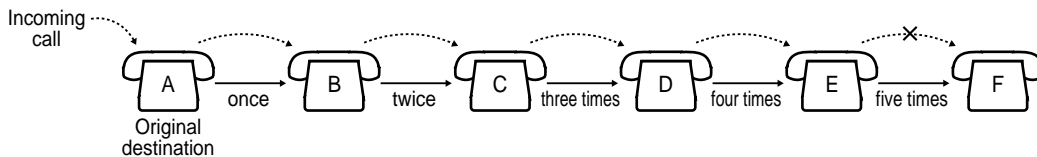

• Boss-Secretary function

The destination extension can call the forwarding receiving group.
<Example>

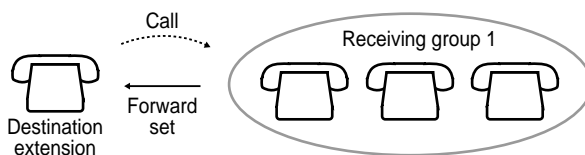

Customising Your Phone

• Customising the Buttons

Create or re-arrange a Call Forwarding from Hunting Group button.



Showing an Absent Message on the Caller's Telephone Display (Absent Message Capability)

You can show the reason for your absence, if the calling extension uses a Panasonic proprietary telephone with a display. This way the caller will know when you will be available. You can choose one of nine messages.

Message no.	Default Message
1	Will Return Soon
2	Gone Home
3	At Ext %%% (Extension number)
4	Back at %%.%% (Hour:Minute)
5	Out until %%%/%% (Month/Day)
6	In a Meeting
7	
8	
9	



- Enter the desired value in the “%” space. You must make your message in all of the “%”s using 0 to 9, #, or *.
- The message can be changed. Consult your dealer.

◆ To set

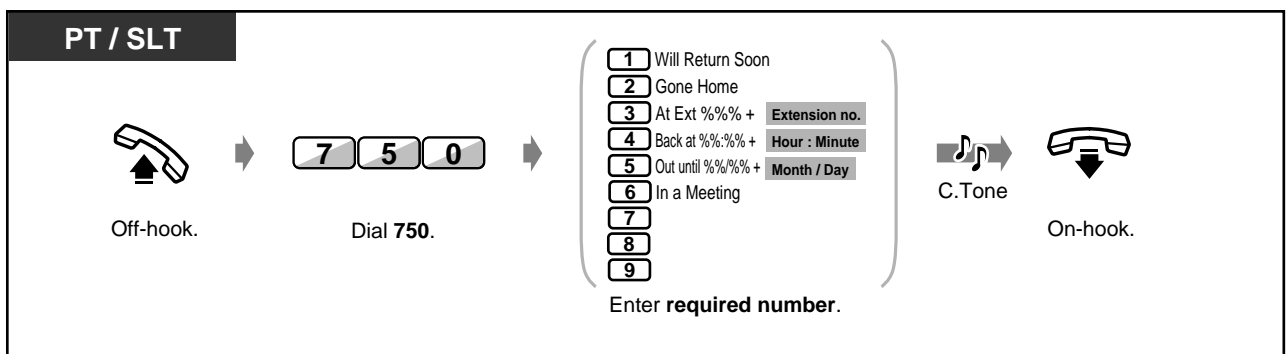

Before Leaving Your Desk

◆ To set (contd.)

T7431

Press **MODE** until "Feature Access" is displayed.

Rotate **Jog Dial** until "ABST MSG On" is displayed.

Press **SELECT**.

Enter **required number**.

1 Will Return Soon
2 Gone Home
3 At Ext %%% + Extension no.
4 Back at %%% + Hour : Minute
5 Out until %%% + Month / Day
6 In a Meeting
7
8
9

C.Tone
On-hook.

T7433

Press **SHIFT** until "FEAT" is displayed.

Press "FEAT".

Rotate **Jog Dial** until "ABST MSG On" is at the arrow.

Press "SEL".

Enter **required number**.

1 Will Return Soon
2 Gone Home
3 At Ext %%% + Extension no.
4 Back at %%% + Hour : Minute
5 Out until %%% + Month / Day
6 In a Meeting
7
8
9

C.Tone
On-hook.

T7436 / T7235

Press "Features".

Rotate **Jog Dial** or press "NEXT" until the following is displayed.

Press "Absent MSG On".

Enter **required number**.

1 Will Return Soon
2 Gone Home
3 At Ext %%% + Extension no.
4 Back at %%% + Hour : Minute
5 Out until %%% + Month / Day
6 In a Meeting
7
8
9

C.Tone
On-hook.



◆ To cancel

PT / SLT

Off-hook. Dial **7500**. C.Tone On-hook.

T7431

Press **MODE** until "Feature Access" is displayed. Rotate **Jog Dial** until "ABST MSG Off" is displayed. Press **SELECT**. C.Tone On-hook.

T7433

Press **SHIFT** until "FEAT" is displayed. Press "FEAT". Rotate **Jog Dial** until "ABST MSG Off" is at the arrow. Press "**SEL**". C.Tone On-hook.

T7436 / T7235

Press "Features". Rotate **Jog Dial** or press "**NEXT**" until the following is displayed. Press "**Absent MSG Off**". C.Tone On-hook.

!!

- To confirm the message, go off-hook. It will be displayed.

Before Leaving Your Desk

Preventing Other People from Using Your Telephone (Electronic Station Lockout)



◆ To lock / unlock

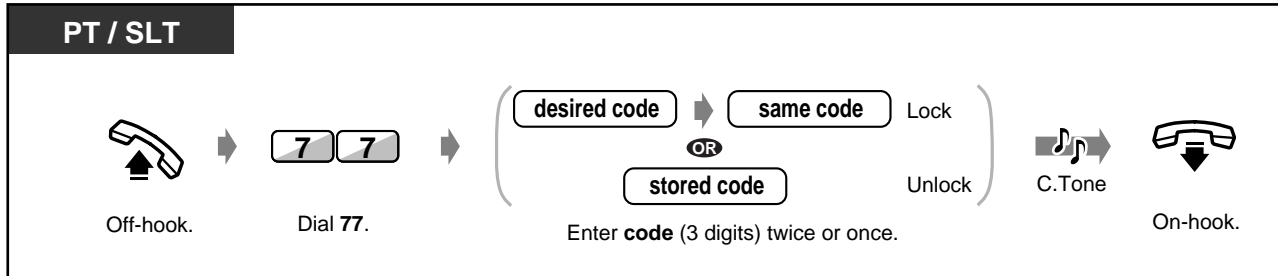

- If you forget the code or cannot unlock your phone, consult an operator. They can unlock your extension (Remote Station Lock Control).

Leaving a Call Distribution Group (Log-In / Log-Out)

You can set your status in a receiving group. Set Log-Out when you leave the office so that incoming calls will temporarily skip your extension in the receiving order. When you return, set Log-In so that calls will reach your extension. (Default: Log-In)

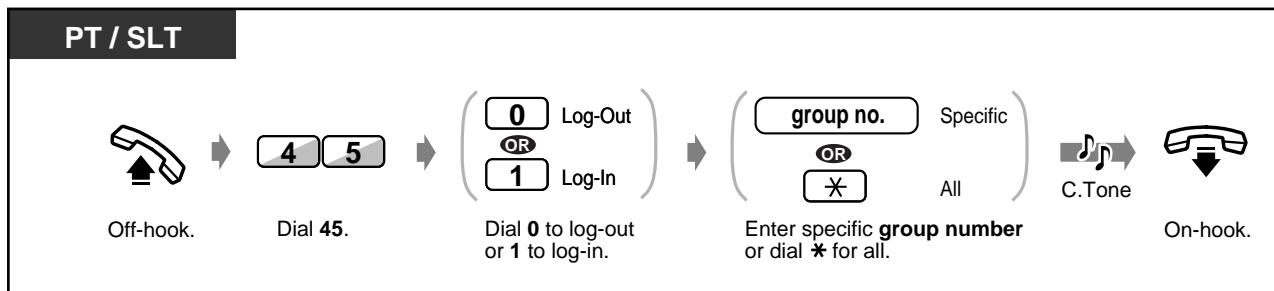
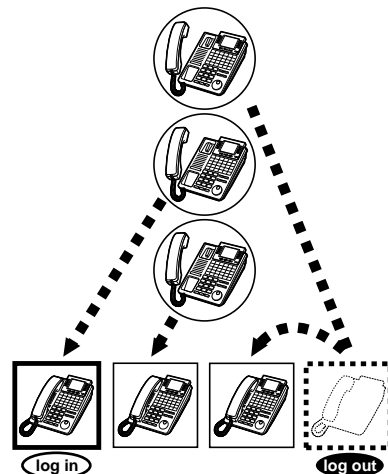

- The Log-In / Log-Out button alternates the setting between Log-In and Log-Out modes. The button light shows the current status as follows:
 - Off:** Log-In mode
 - Red on:** Log-Out mode
 - Flashing red:** a call waiting
- This feature is not available for an ISDN telephone user.

Customising Your Phone

- **Customising the Buttons**
Create or re-arrange a Log-In / Log-Out button.

Making / Answering an Announcement

Paging

You can make a voice announcement to several people at the same time. Your message is sent over the proprietary telephone speakers and/or external speakers. The paged person can answer your paging from any telephone. There are three types as shown below:

All: Paging through both the telephone speakers and external speakers.

External: Paging through the external speakers.

Group: Paging to a particular extension group or all groups (all extensions) through the telephone speakers.

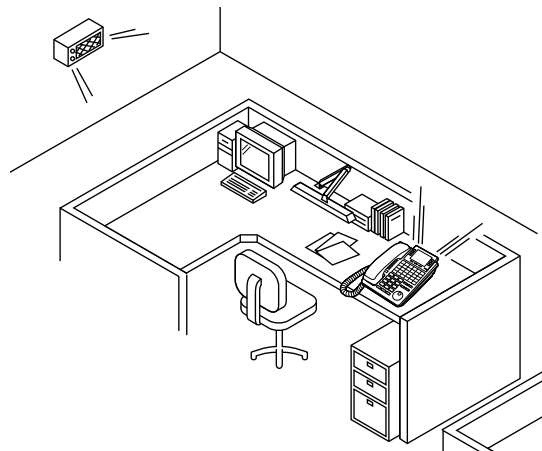

◆ All

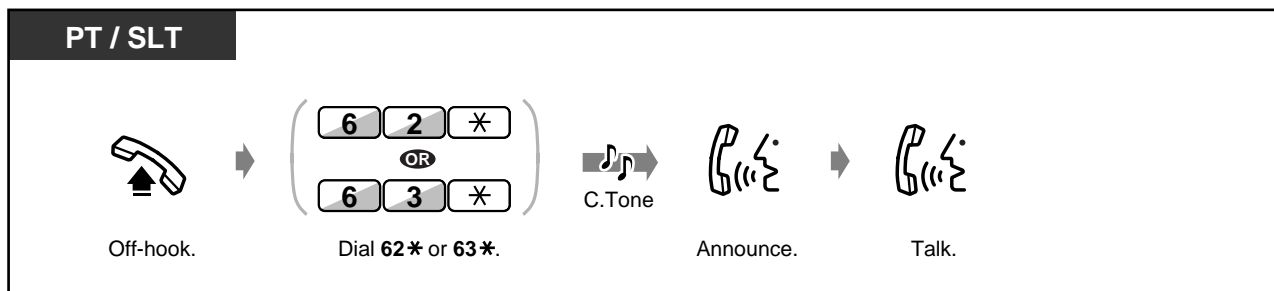

◆ External

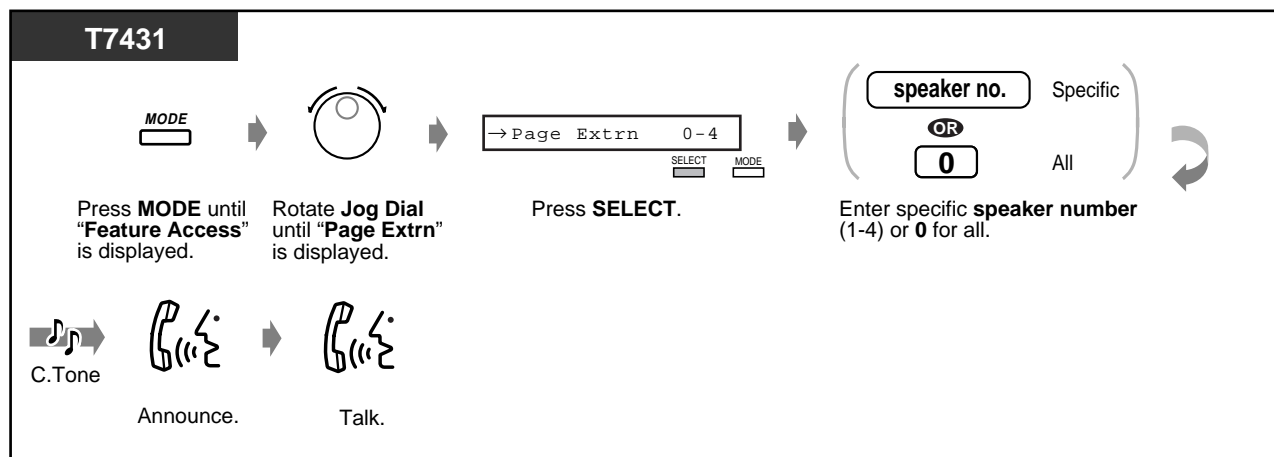
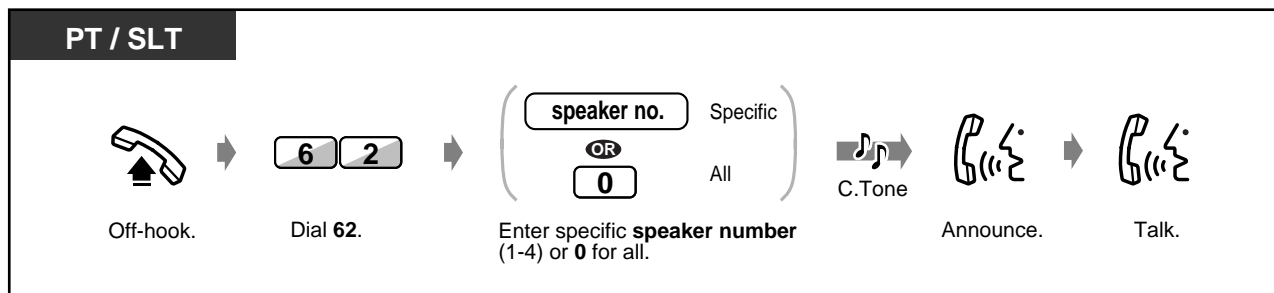



◆ External (contd.)

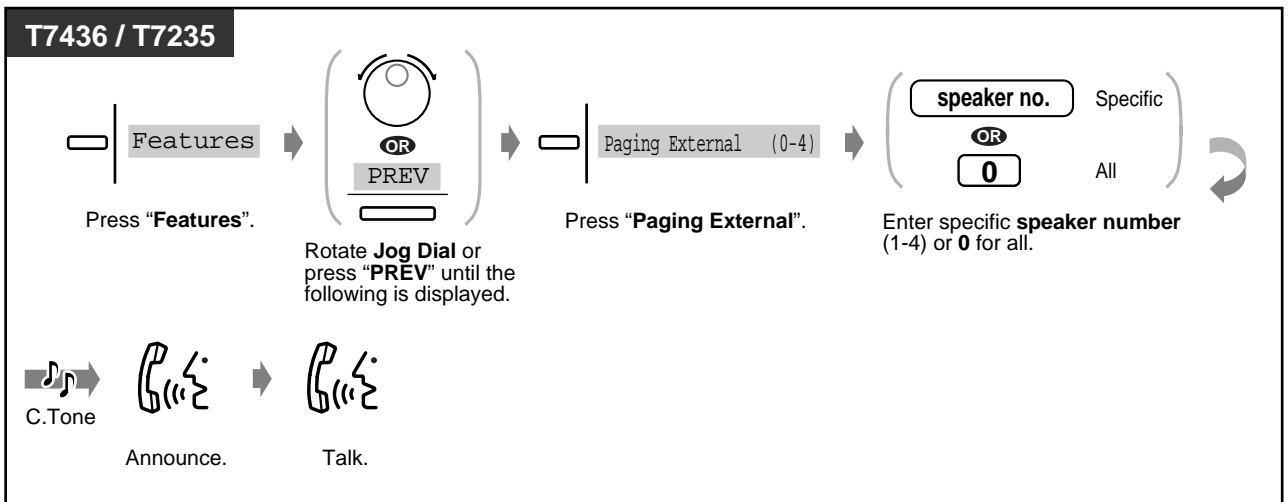
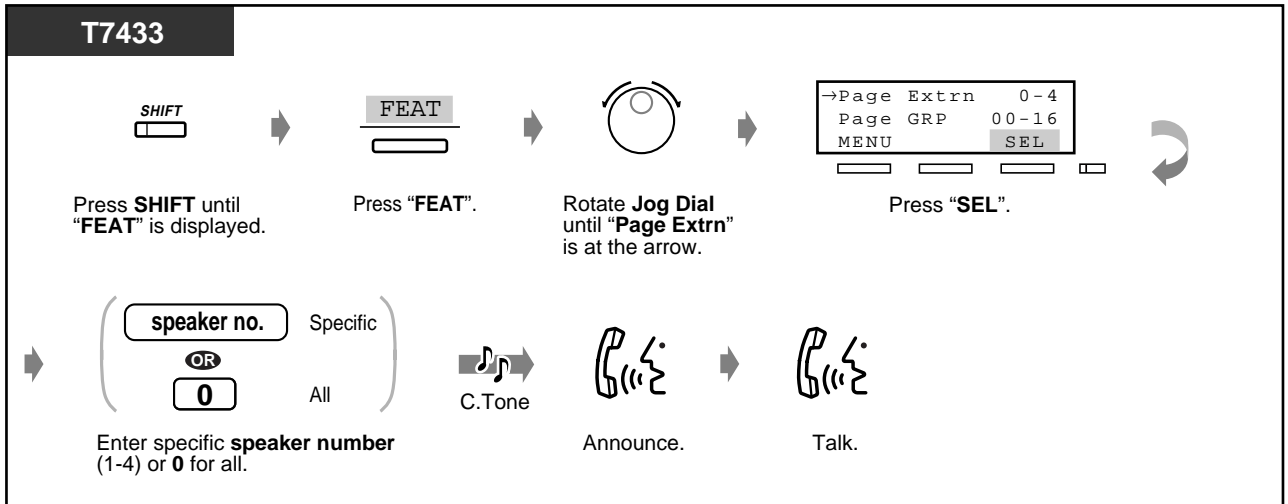

◆ Group

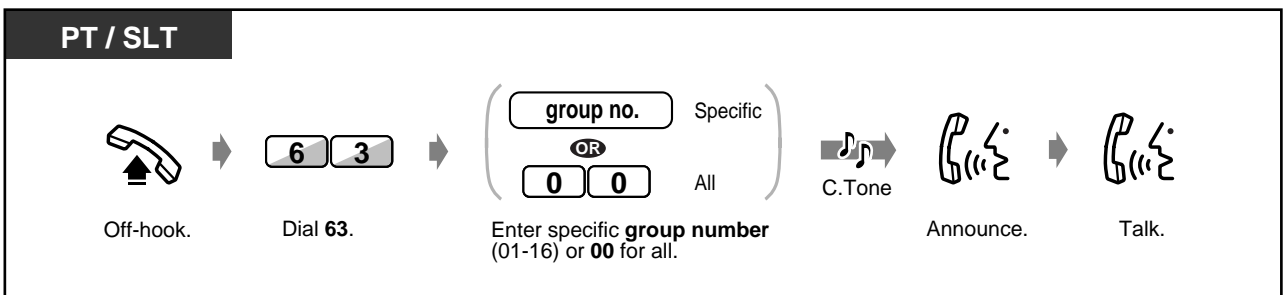

Making / Answering an Announcement

◆ Group (contd.)

T7431

Press **MODE** until "Feature Access" is displayed.

Rotate **Jog Dial** until "Page GRP" is displayed.

Press **SELECT**.

Enter specific **group number** (01-16) or **00** for all.

group no. Specific
OR
0 0 All

C.Tone → Announce. → Talk.

T7433

Press **SHIFT** until "FEAT" is displayed.

Press "FEAT".

Rotate **Jog Dial** until "Page GRP" is at the arrow.

Press "SEL".

Enter specific **group number** (00-16) or **00** for all.

group no. Specific
OR
0 0 All

C.Tone → Announce. → Talk.

T7436 / T7235

Press "Features".

Rotate **Jog Dial** or press "PREV" until the following is displayed.

Press "Paging Group".

Enter specific **group number** (00-16) or **00** for all.

group no. Specific
OR
0 0 All

C.Tone → Announce. → Talk.



- A ringing, busy, Do Not Disturb extension, or a single line telephone cannot receive a paged announcement.
- The proprietary telephone user can deny a paged announcement. For more details, refer to the page 2-63.



Paging a Person and Transferring a Call

◆ Through a speaker and telephones

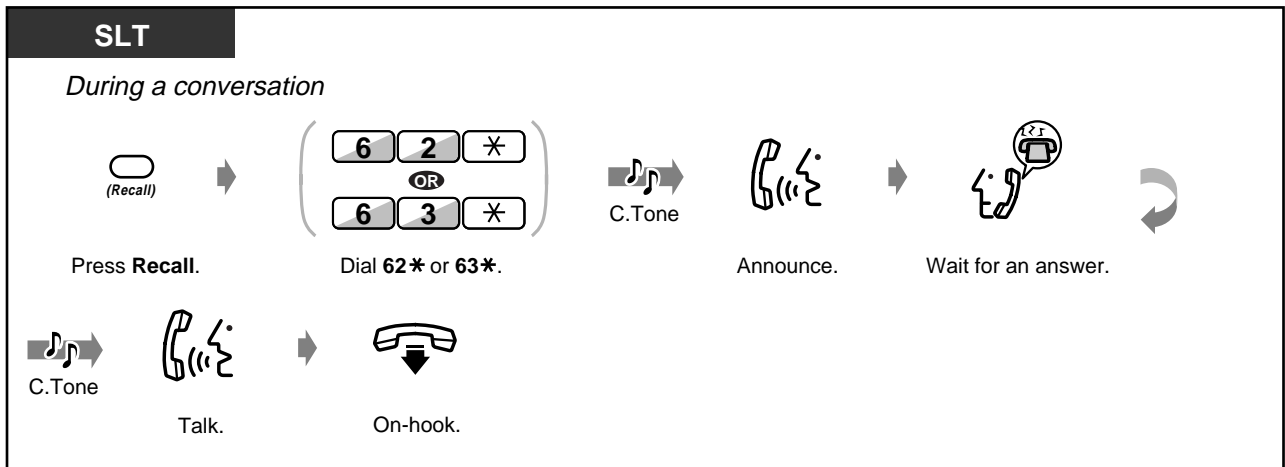
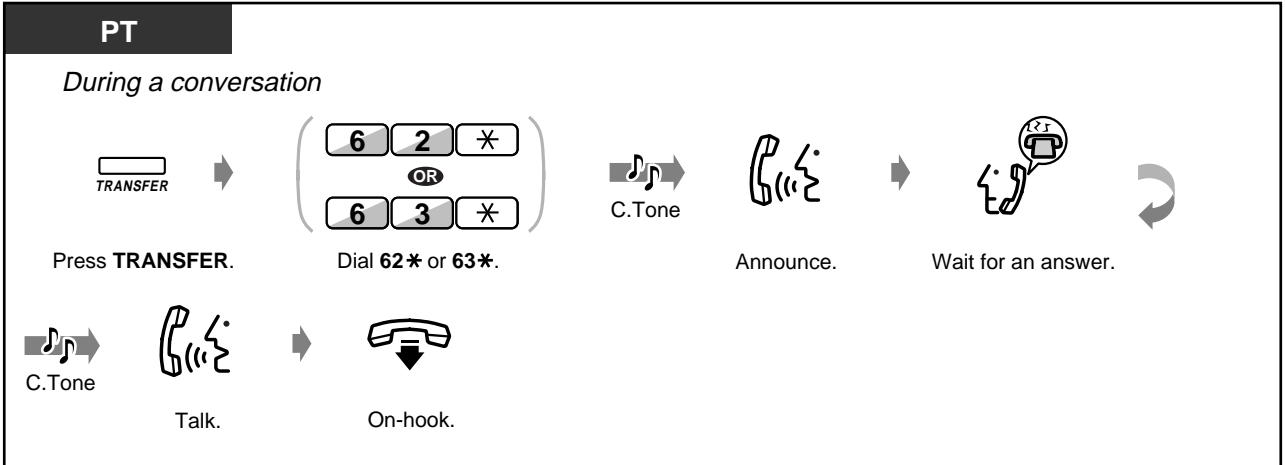

◆ Through a speaker

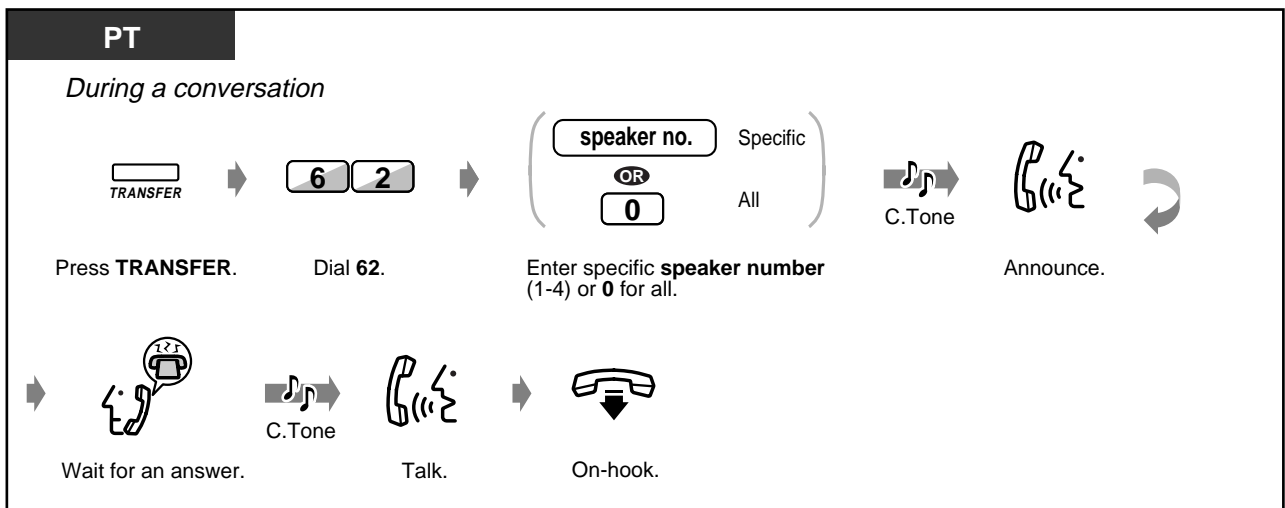

Operation

Making / Answering an Announcement

◆ Through a speaker (contd.)

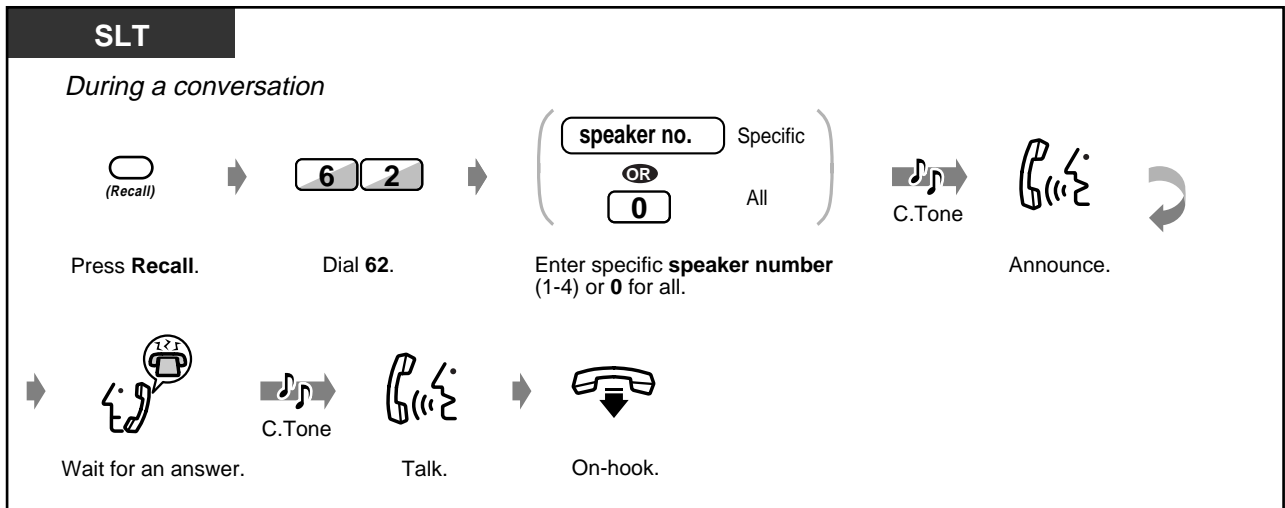

◆ Through the telephone of a particular extension group

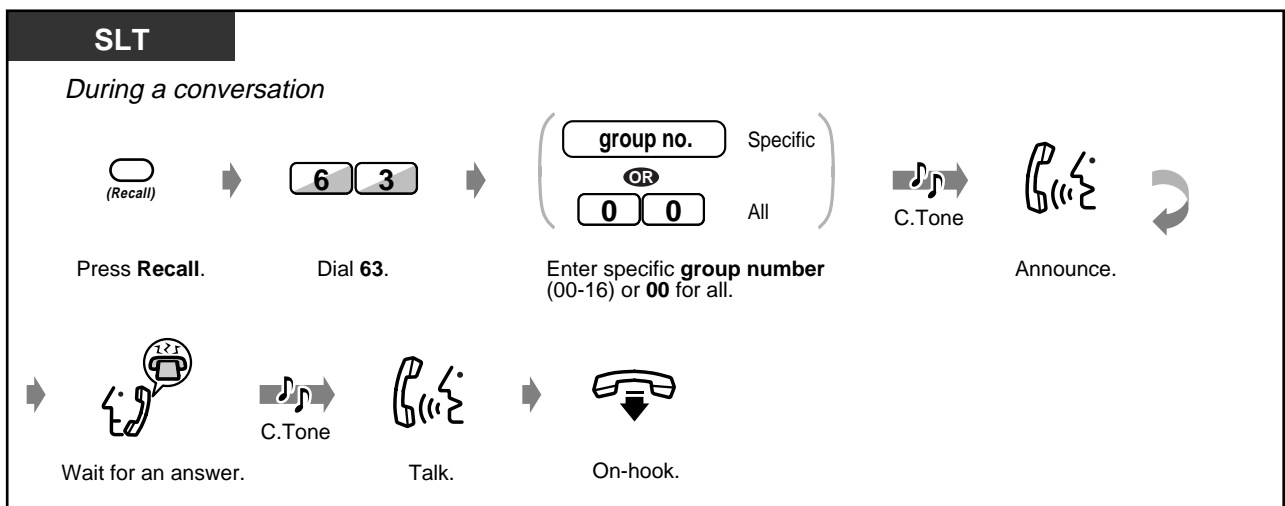
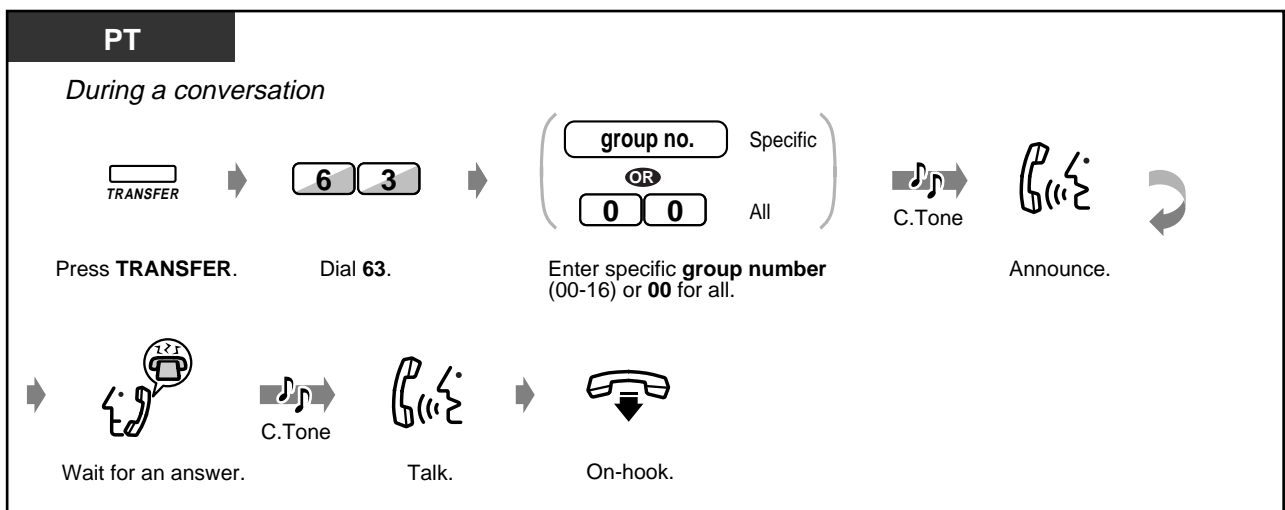



Answering a Paged Announcement

◆ Through a speaker

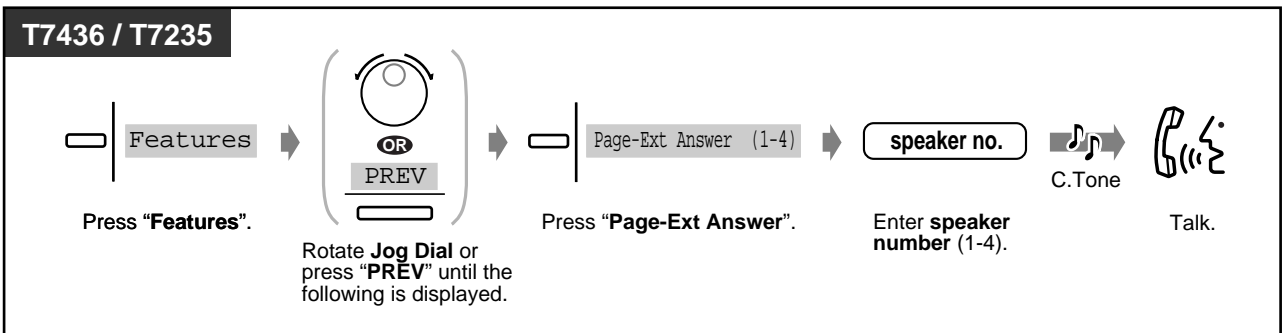
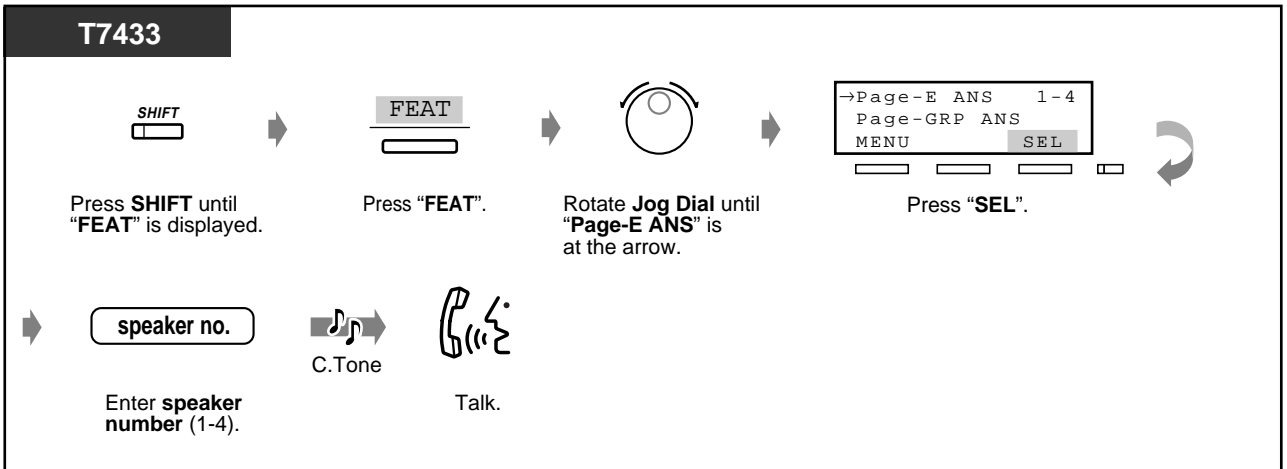
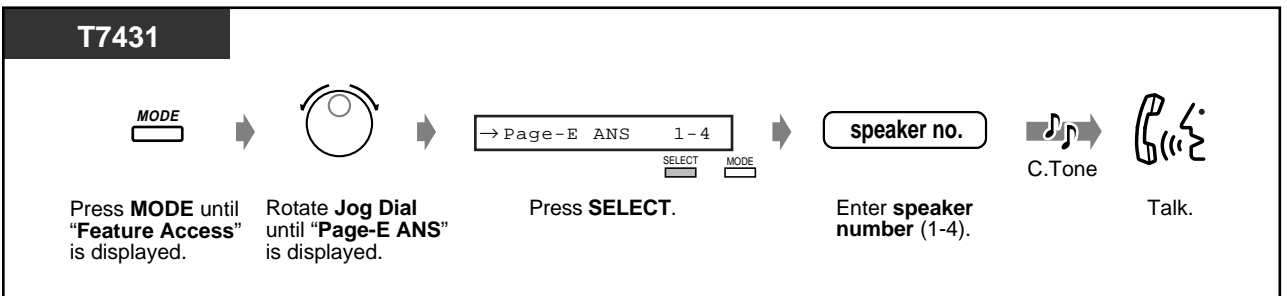
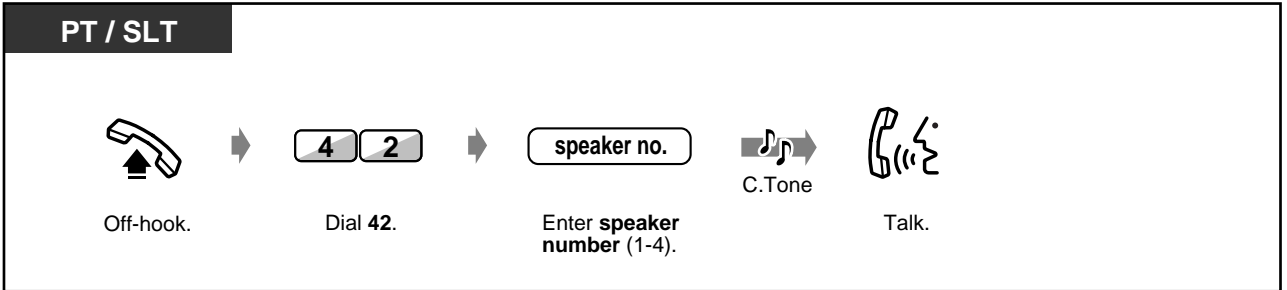

• This feature is not available for an ISDN telephone user.

Making / Answering an Announcement

◆ Through the telephones

PT / SLT

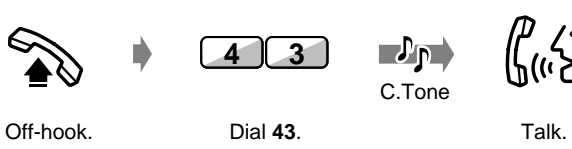

Off-hook. Dial 43. C.Tone Talk.

T7431

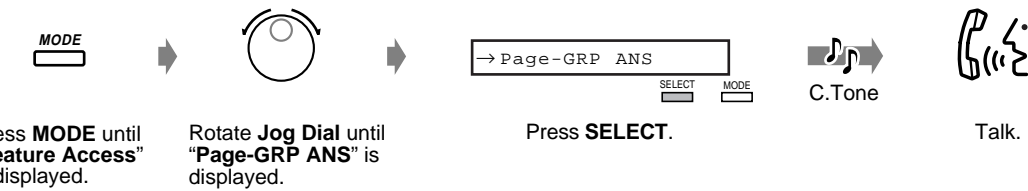

Press **MODE** until "Feature Access" is displayed. Rotate **Jog Dial** until "Page-GRP ANS" is displayed. Press **SELECT**. C.Tone Talk.

T7433

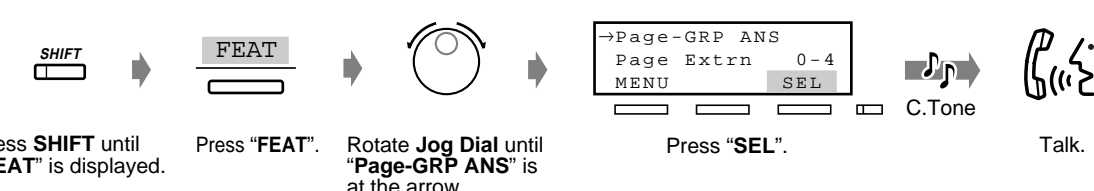

Press **SHIFT** until "FEAT" is displayed. Press "FEAT". Rotate **Jog Dial** until "Page-GRP ANS" is at the arrow. Press "**SEL**". C.Tone Talk.

T7436 / T7235

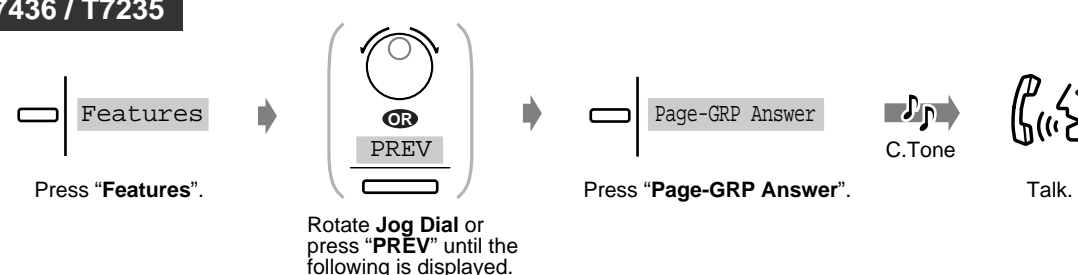

Press "**Features**". Rotate **Jog Dial** or press "**PREV**" until the following is displayed. Press "**Page-GRP Answer**". C.Tone Talk.

Setting the Telephone According to Your Needs

Setting the Alarm (Timed Reminder)

You can receive a ringback alarm at your telephone to remind you of a meeting, appointment or as a wake-up call. The setting can be for either one time or daily (every day until cancelled) at a pre-set time.

◆ To set

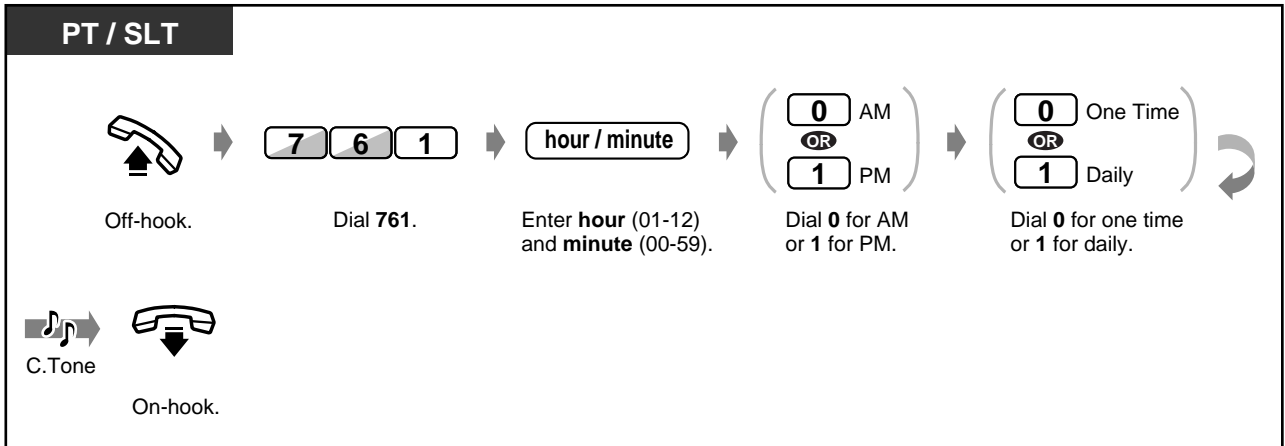

◆ To cancel

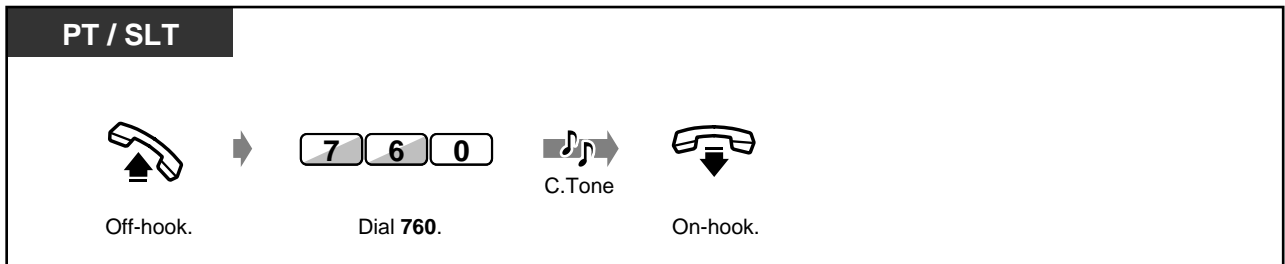

◆ To view the setting

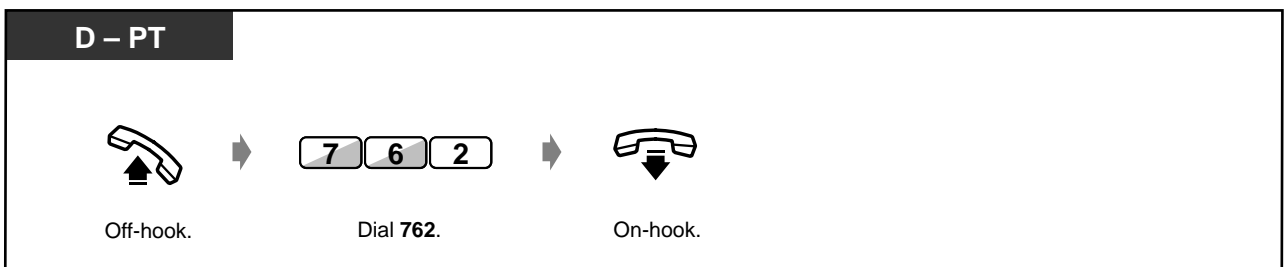

Setting the Telephone According to Your Needs

◆ To stop or answer the ringback

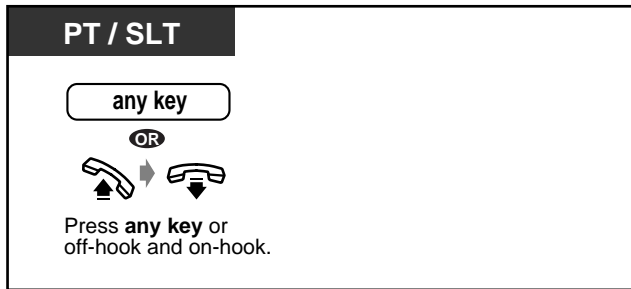

- **If you receive an incoming call during ringback,** ringing starts after the ringback stops.
- **If you are having a conversation during the pre-set time,** the ringback will start after your conversation.
- This feature is not available for an ISDN telephone user.
- If you go off-hook to answer, you can hear the alarm tone or the recorded message which the operator pre-assigned.



When the daily alarm is set, the display shows “:” in the corner.

Alarm 10:10AM*



Refusing Incoming Calls (Do Not Disturb [DND])

– Refusing all calls

– Refusing direct outside calls

◆◆ Refusing all calls

You may set this feature during a meeting or when you are busy. Outside calls can be forwarded to a backup station (pre-assigned extension or the operator).

◆ To set

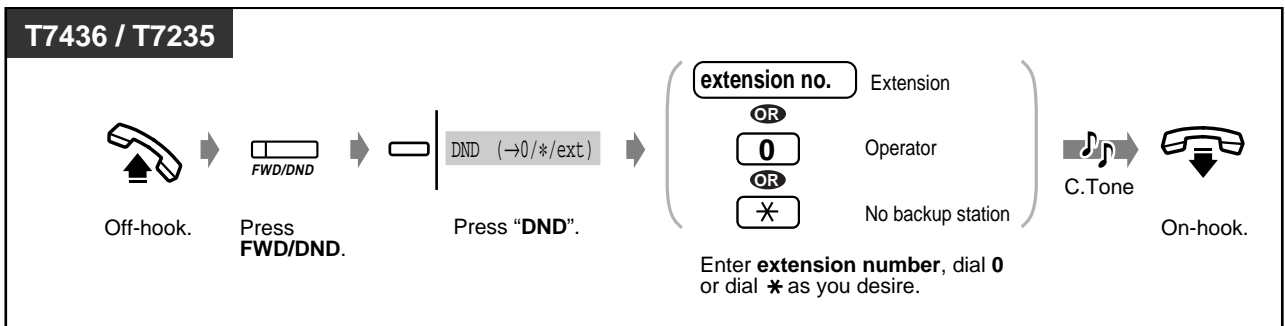
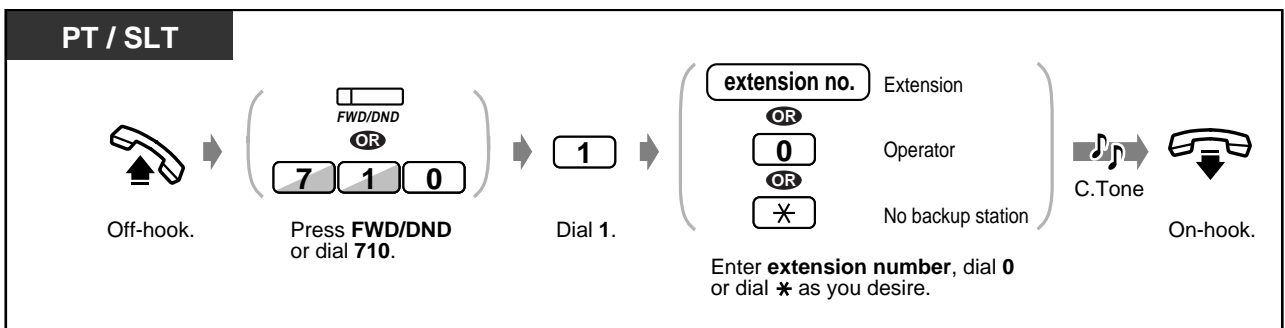

◆ To cancel

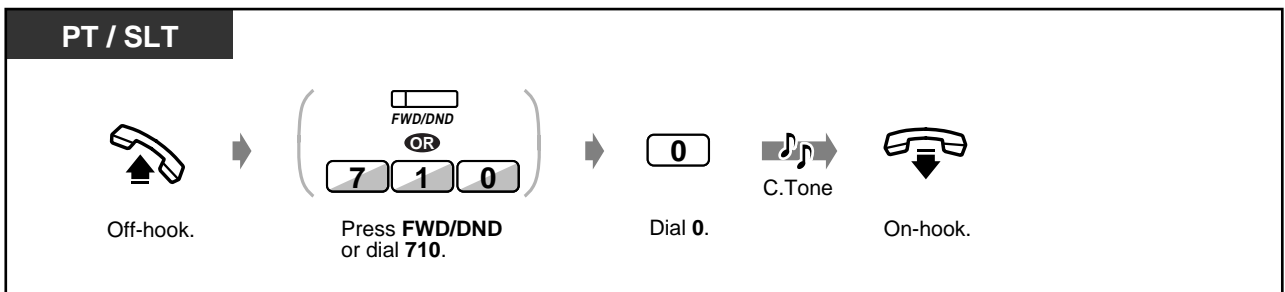

Setting the Telephone According to Your Needs

◆ To cancel (contd.)

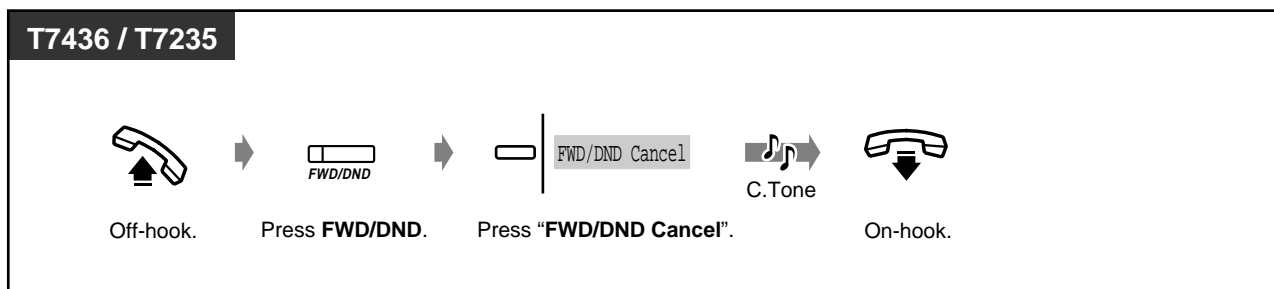

◆◆ Refusing direct outside calls (DND for Direct Dialling In Calls)

You can set your extension to refuse direct outside calls and have them forwarded to the operator. The operator cannot set this feature.

◆ To set / cancel

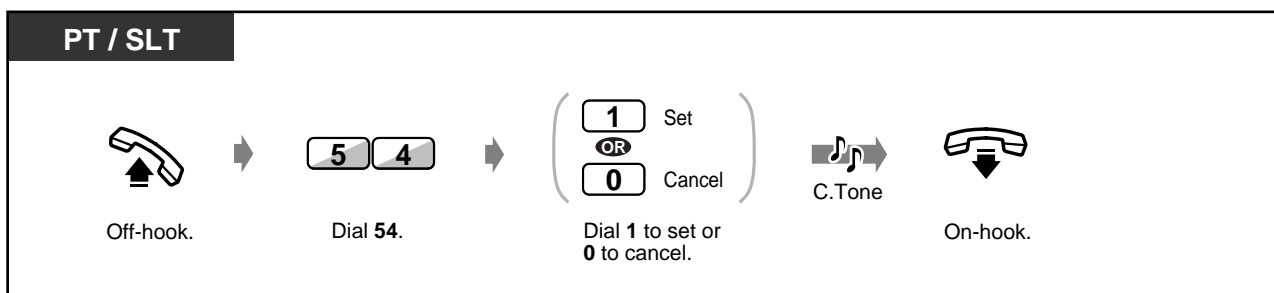

- A flashing CO button tells you an outside call is received. You can answer the call by pressing the CO button.
- The following button lights turn red when the DND feature is set.
 - Your FWD/DND button.
 - The DSS button on other extensions where your extension number has been assigned.
- The following features cannot be set at the same time.
 - Forwarding your calls (Call Forwarding)
 - Refusing all calls (Do Not Disturb [DND])
 - Refusing direct outside calls (DND for Direct Dialling In Calls)The most recent feature set overrides the previous setting.
- These features are not available for an ISDN telephone user.



Customising Your Phone

• Customising the Buttons

Create or re-arrange a FWD/DND button.



Receiving a Call Waiting

(Call Waiting / Off-Hook Call Announcement [OHCA] / Whisper OHCA)

During a conversation, you can be informed a call waiting with a tone or voice announcement through your speaker or handset. (Default: No tone)

Call waiting tone: a waiting tone through the handset

You can change the tone, refer to “Customising Your phone”.

OHCA: a voice announcement through the handset without pre-information

(KX-T7436 and KX-T7235 telephone users only)

Whisper OHCA: a voice announcement through the handset without pre-information

(KX-T7400 series telephone users only)

◆ To set / cancel

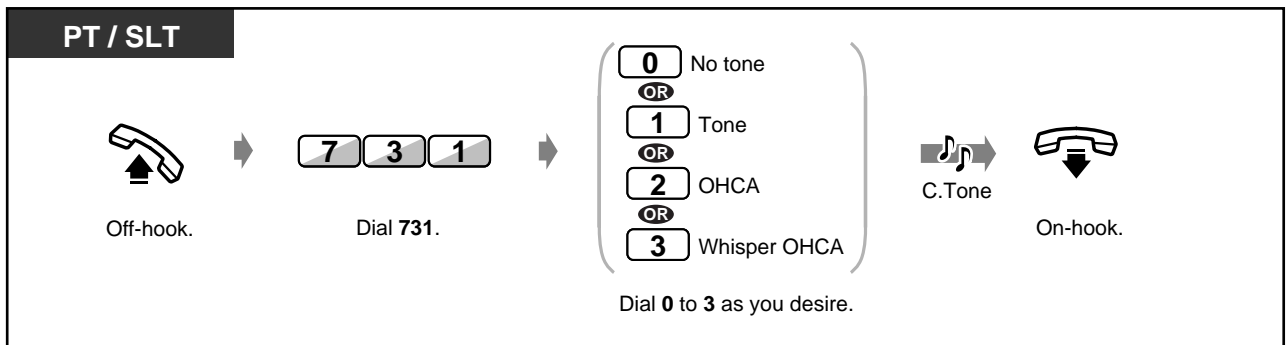

- You can set or cancel the Call Waiting features by simply pressing the Call Waiting button. Pressing this button changes the features as follows:

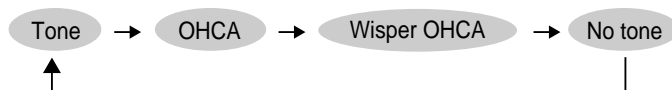

If the Call Waiting tone, OHCA or Whisper OHCA is selected, the button light turns red.

- This feature is not available for an ISDN telephone user.



Customising Your Phone

• Customising the Buttons

Create or re-arrange a Call Waiting button.

Setting the Telephone According to Your Needs

Denying the Paged Announcement (Paging — DENY)

You can refuse any paged announcement sent through your speaker.

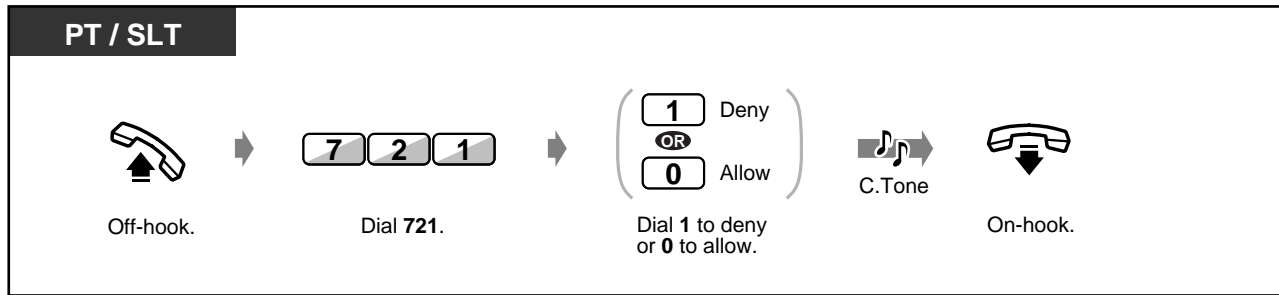

- You can deny or allow this feature by simply pressing the Paging Deny button. If denied, the button light turns red.



Customising Your Phone

- **Customising the Buttons**

Create or re-arrange a Paging Deny button.



■ **Displaying Your Number on the Called Party and Calling Party's Telephone**

(Calling / Connected Line Identification Presentation [CLIP / COLP])

CLIP : When making a call, you can let the other party see your pre-assigned identification number.
COLP : When receiving a call, you can let the party calling you see your pre-assigned identification number.

You can select to show an identification number assigned for an outside line or your extension.
You can also show a desired identification number when making a particular call.

◆ **To show an identification number assigned for an outside line or your extension**

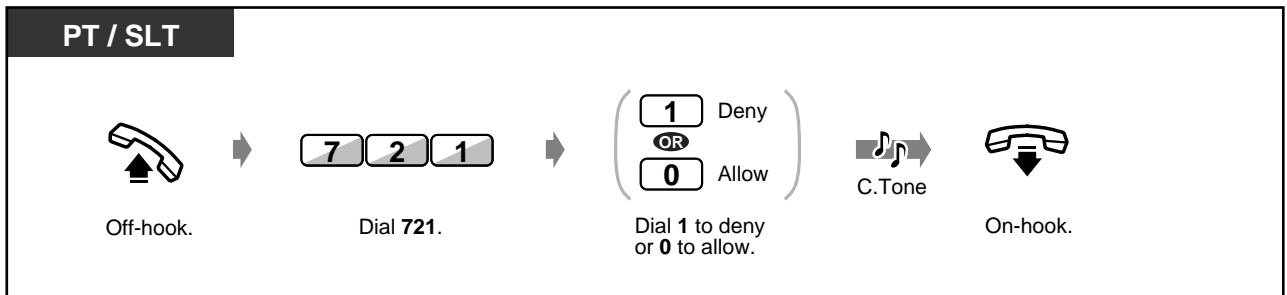

◆ **To show a desired identification number when making a particular call**

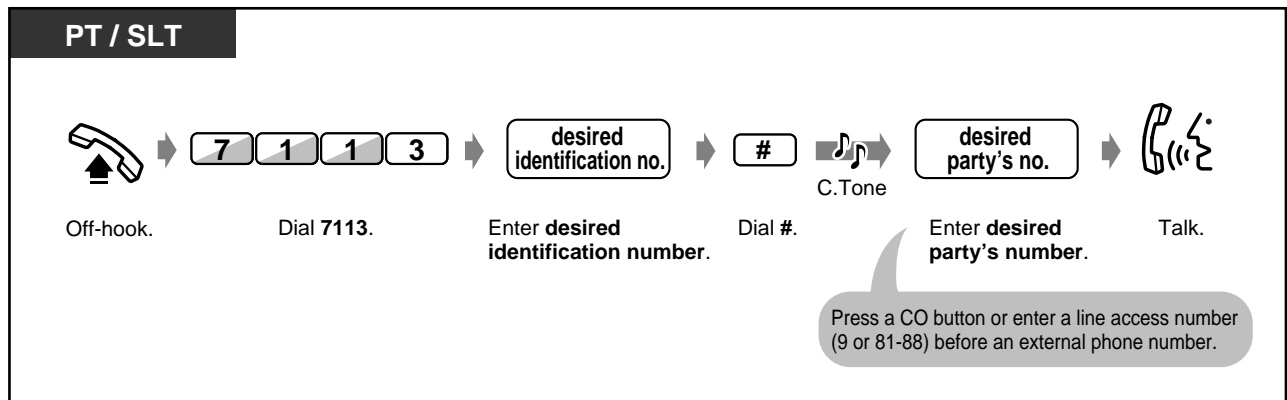

Setting the Telephone According to Your Needs

Preventing Your Number Being Displayed on the Called Party's Telephone

(Calling Line Identification Restriction [CLIR])

When making a call, you can prevent the other party from seeing your identification number. You can change the setting at any time for a particular call.

◆ To set / cancel

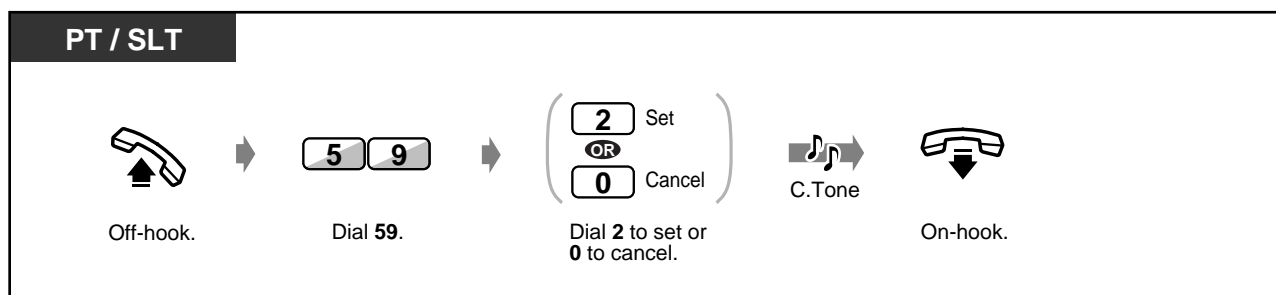

◆ To change the setting at any time for a particular call

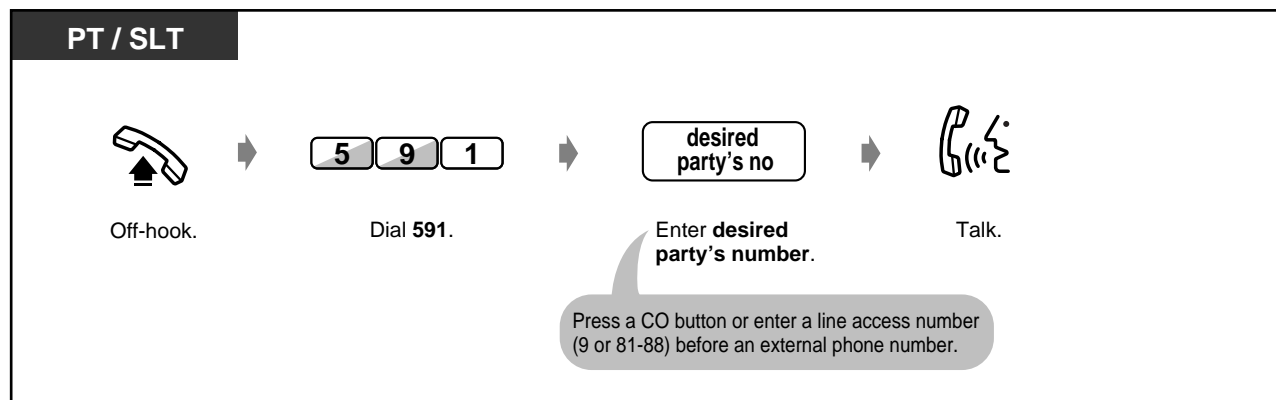

• You can set or cancel this feature by simply pressing the CLIR button. If set, the button light turns red.



Customising Your Phone

• Customising the Buttons

Create or re-arrange a Calling Line Identification Restriction (CLIR) button.



Preventing Your Number Being Displayed on the Calling Party's Telephone

(Connected Line Identification Restriction [COLR])

When receiving a call, you can prevent the party calling you from seeing your identification number.

◆ To set / cancel

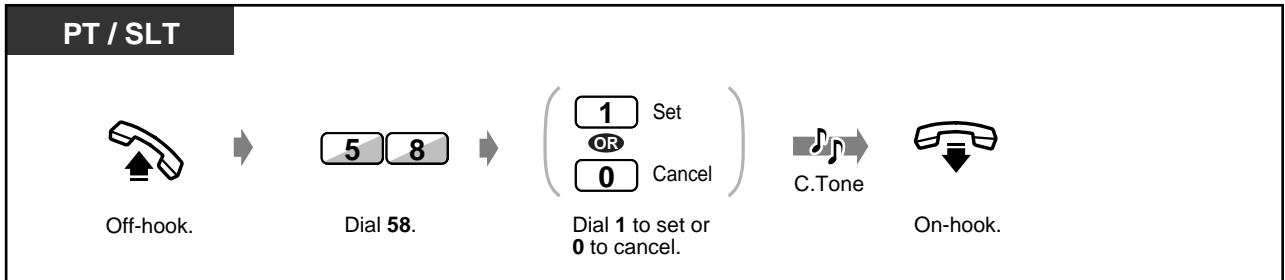

- You can set or cancel this feature by simply pressing the COLR button. If set, the button light turns red.



Customising Your Phone

• Customising the Buttons

Create or re-arrange a Connected Line Identification Restriction (COLR) button.

Denying Other People the Possibility of Picking up Your Calls (Call Pickup Deny)

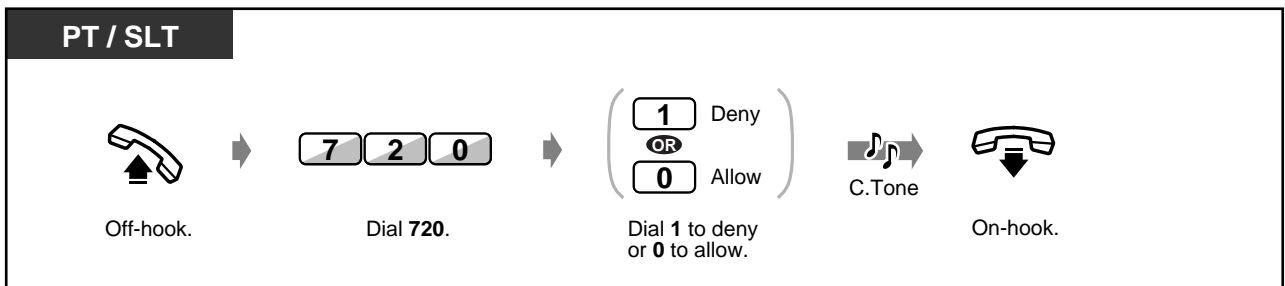

- You can deny or allow or cancel this feature by simply pressing the Call Pickup Deny button. If it is denied, the button light turns red.



Customising Your Phone

• Customising the Buttons

Create or re-arrange a Call Pickup Deny button.

Setting the Telephone According to Your Needs

Turning on the Background Music

You can listen to background music through your telephone speaker while on-hook. An external music source, such as a radio, must be connected.



◆ To set / cancel

PT

While on-hook

BGM

OR

HOLD

Press **"BGM"** or **HOLD**.

Checking the Day / Night Service Status

You can manage your system under different conditions for either day time (business hours) or night time (after business hours).



D – PT

While on-hook

#

Dial #.

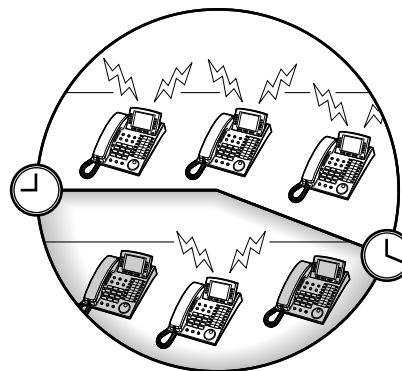

- Any extension user can check the status.
- The Night button light shows the current status as follows:
 - Off:** Day mode
 - Red:** Night mode



Customising Your Phone

- **Customising the Buttons**
 - Create or re-arrange a Night button.



Setting the Parallel Connected Telephone Ringer (Paralleled Telephone)

A proprietary telephone user can choose whether the single line telephone connected in parallel will ring or not, when an incoming call is received.
(Default: No ring)



PT / SLT

Off-hook. Dial 69. Dial 1 to ring or 0 to no ring. C.Tone On-hook.

T7431

Press **MODE** until "Feature Access" is displayed. Rotate **Jog Dial** until "Parallel" is displayed. Press **SELECT**. Dial 1 to ring or 0 to no ring. C.Tone On-hook.

T7433

Press **SHIFT** until "FEAT" is displayed. Press "FEAT". Rotate **Jog Dial** until "Parallel" is at the arrow. Press "SEL". Dial 1 to ring or 0 to no ring. C.Tone On-hook.

Setting the Telephone According to Your Needs

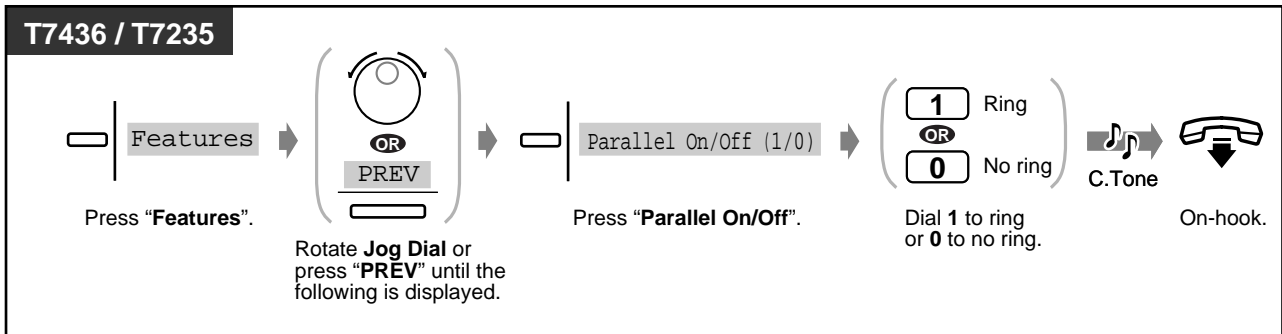

- You can select "Ring" or "No ring" by simply pressing the Paralleled Telephone Connection button. If "Ring" is selected, the button light turns red.
- **Even if "No ring" is selected**, the call can be answered with the single line telephone by lifting the handset.
- If you go off-hook while your paralleled telephone is in use, the call will switch over to your telephone, and vice versa.
- This feature is not available for an ISDN telephone user.



Customising Your Phone

• Customising the Buttons

Create or re-arrange a Paralleled Telephone Connection button.

Clearing the Feature Settings at Your Extension (Station Program Clear)

You can clear the following features which have been set on your phone. If you change desks, and notice settings which a previous owner left on the line, you can clear these features.

- Calling to a Pre-set Party by Going Off-Hook (Pickup Dialling): The stored number will be cleared.
- Reserving a Busy Line (Automatic Callback Busy)
- Leaving a Message Waiting Indication (Message Waiting): All messages will be removed.
- Forwarding Your Calls (Call Forwarding)
- Showing an Absent Message on the Caller's Telephone Display (Absent Message Capability)
- Leaving a Call Distribution Group (Log-In/Log-out)
- Calling Using the Call Log (Incoming Call Log)
- Setting the Alarm (Timed Reminder)
- Refusing Incoming Calls (Do Not Disturb [DND])
- Receiving a Call Waiting (Call Waiting / Off-Hook Call Announcement [OHCA] / Whisper OHCA)
- Denying the Paged Announcement (Paging — Deny)
- Denying Other People the Possibility of Picking up Your Calls (Call Pickup Deny)
- Turning on the Background Music
- Setting the Parallel Connected Telephone Ringer (Paralleled Telephone): The single line telephone will not ring.
- Preventing Your Number Being Displayed on the Called Party's Telephone (CLIR)
- Preventing Your Number Being Displayed on the Calling Party's Telephone (COLR)

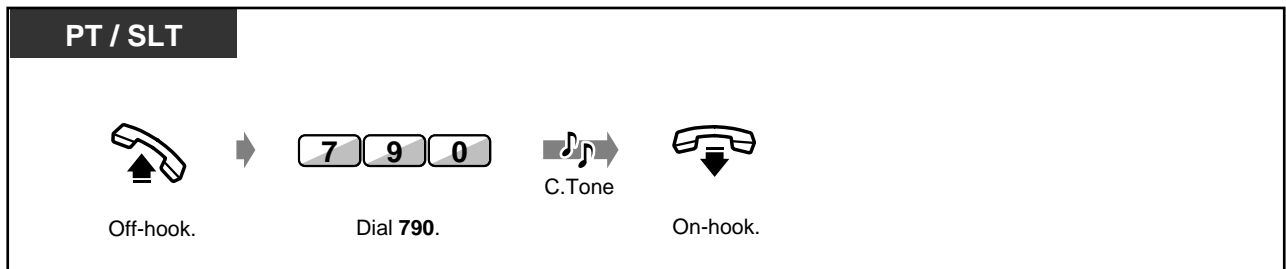

Using User-supplied Equipment

If a Doorphone / Door Opener is Connected

- Doorphone call
- Forwarding doorphone calls to outside parties
- Opening the door

◆◆ Doorphone call

◆ To call from the doorphone

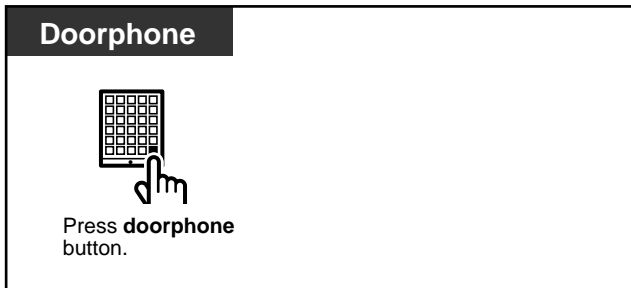

◆ To call the doorphone

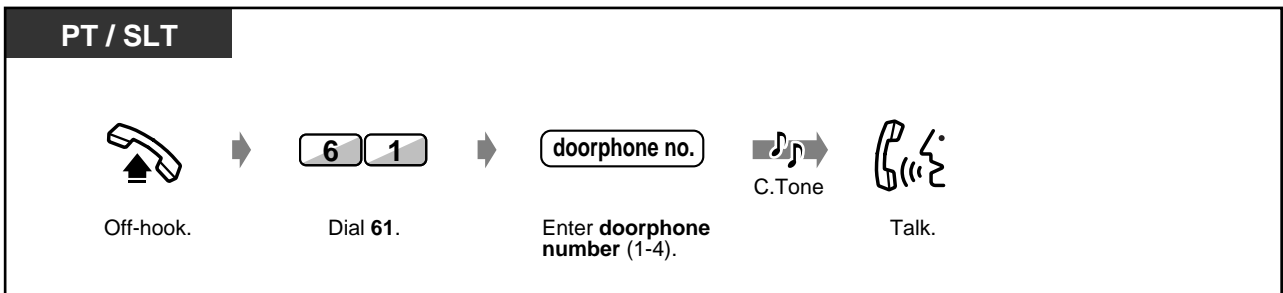



Forwarding Doorphone Calls to Outside Parties

(Doorphone Call Forwarding to Outside Line)

You can have incoming doorphone calls forwarded to outside parties using ISDN lines.
You can choose a different destination for Day mode and Night mode.
Some extensions may be restricted.

◆ To set / cancel (at the extension receiving doorphone calls)

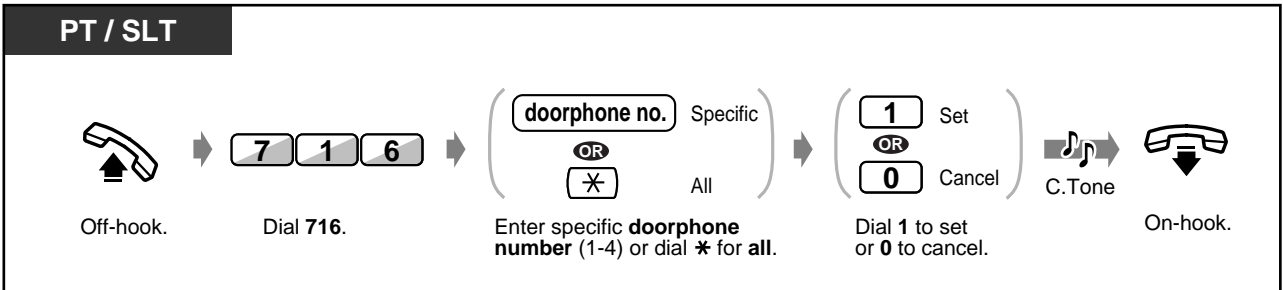

◆ To store the phone number

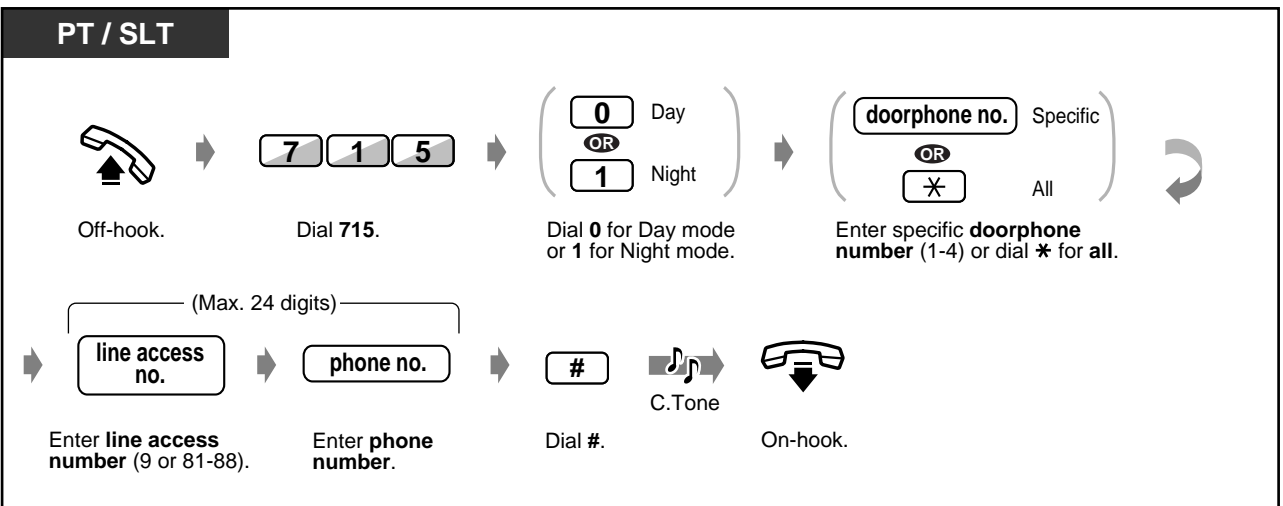

◆ To clear the phone number

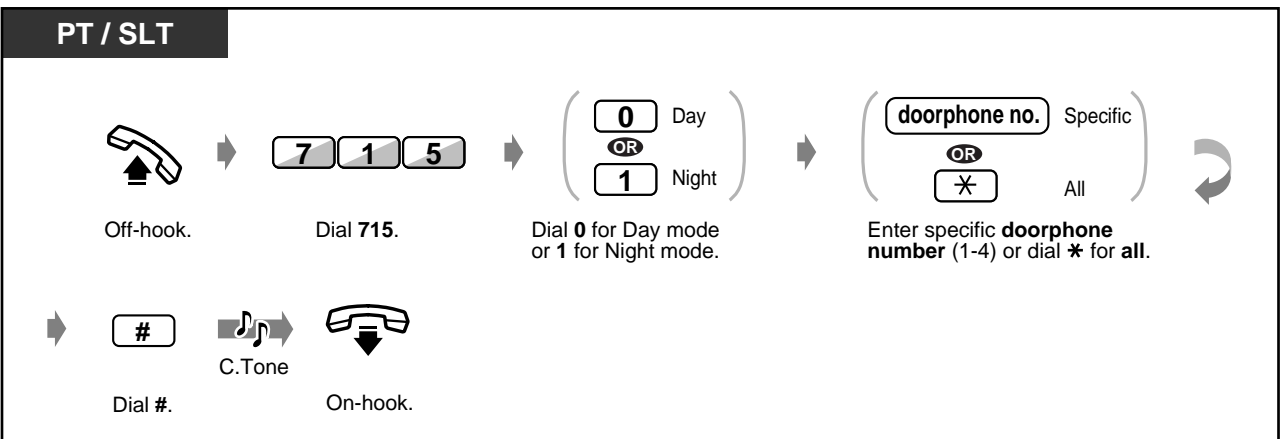

Using User-supplied Equipment



- You can set or cancel this feature by simply pressing the Doorphone Call Forwarding to Outside Line button. If set, the button light turns red.
- Time limit**
A call between a party at a doorphone and an outside party is restricted by the system timer (Default: 0 sec.). The call is disconnected when the time runs out.



Customising Your Phone

• Customising the Buttons

Create or re-arrange a Doorphone Call Forwarding to Outside Line button.

◆◆ Opening the door

Some extensions may be restricted from performing this function.

◆ From a specified extension

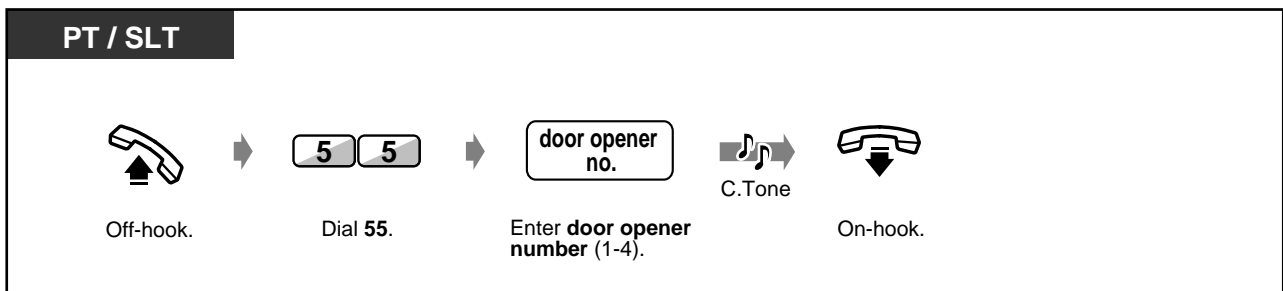

◆ From any extension while talking to the doorphone

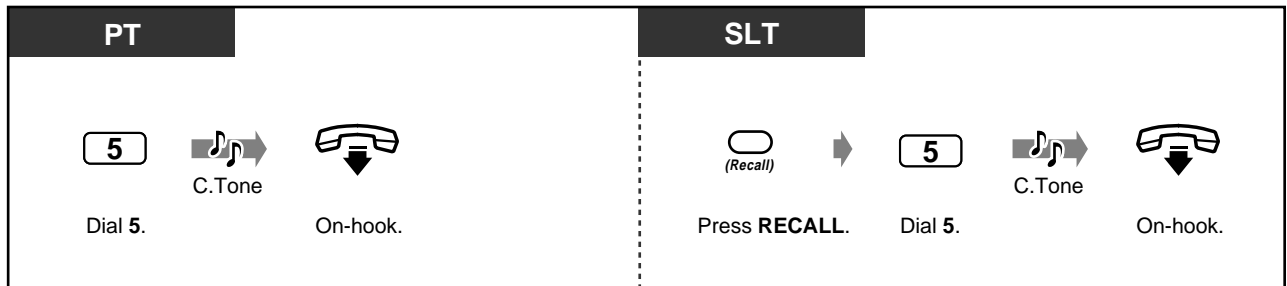

- The door will be left open for five seconds.
- To keep the door open for another five seconds**, dial 5 again using a Panasonic proprietary telephone.
- If no one answers the doorphone call within 30 seconds**, the call is cancelled.



If a Host PBX is Connected

◆◆ Accessing external services (External Feature Access)

You can access special features (e.g. Call Waiting) offered by a host PBX or Central Office. This feature is only effective with an outside call.

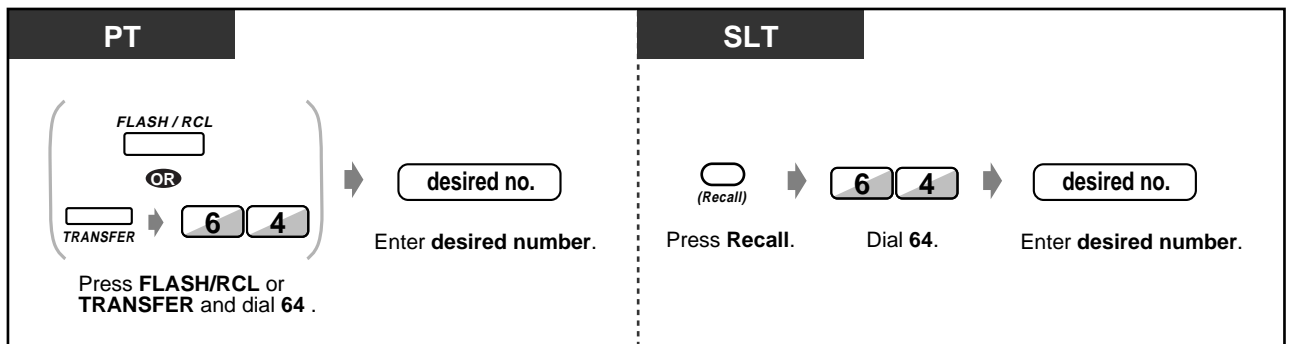
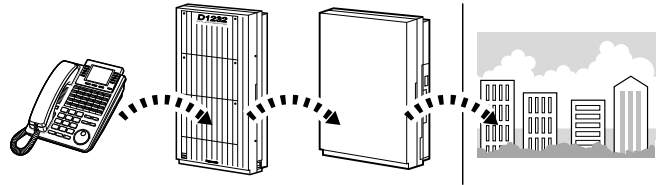

Using User-supplied Equipment

If a Voice Processing System is Connected

– Voice mail integration

If your system is connected to a Panasonic Voice Processing System (e.g. KX-TVP100) which can be used with a digital proprietary telephone, the following functions are available:

– Screening calls – Recording a conversation

Voice mail integration

If you cannot answer calls, you can forward them to your mailbox. If your telephone has a MESSAGE button, the button light turns on and lets you know you have messages. Even if a MESSAGE button is not provided, you will hear an indication tone* when going off-hook.

You can also transfer received outside calls to a certain mailbox so that callers can leave messages.

If you create a Voice Mail Transfer button on your phone, the transfer is done easily without confirming the voice mail extension number (Voice Mail Transfer).

To forward your calls to a mailbox

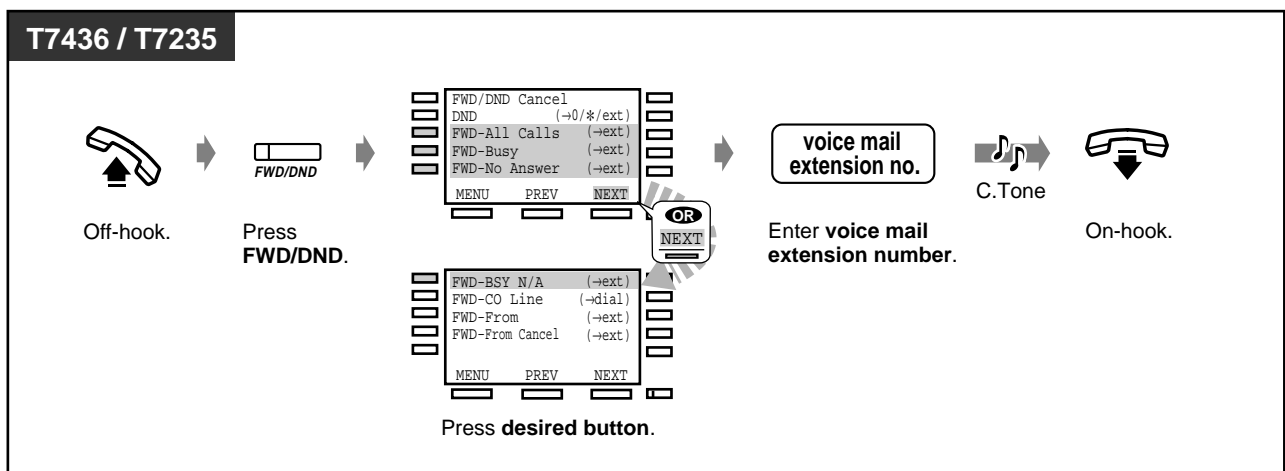
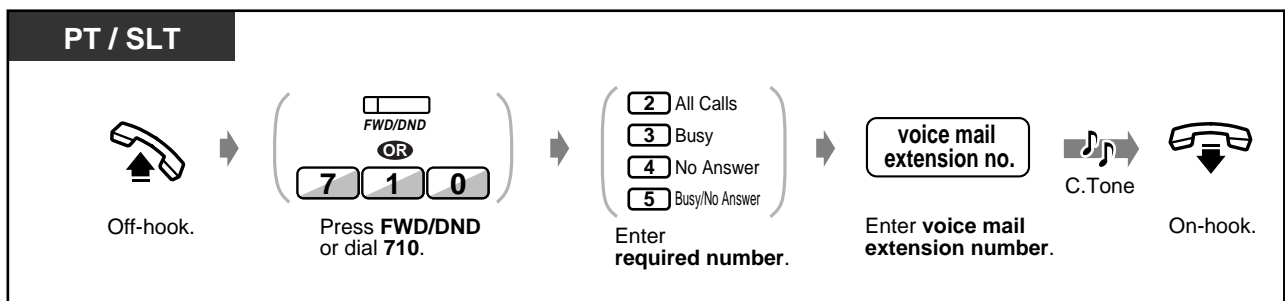



◆ Transferring calls

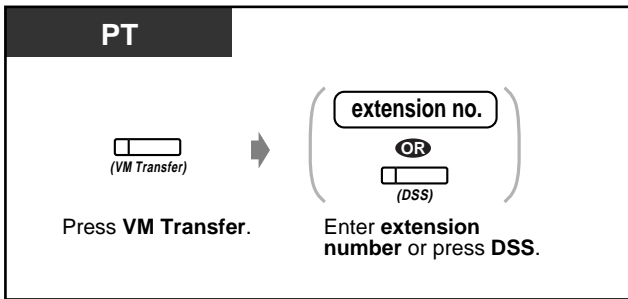

◆ To listen to a stored message

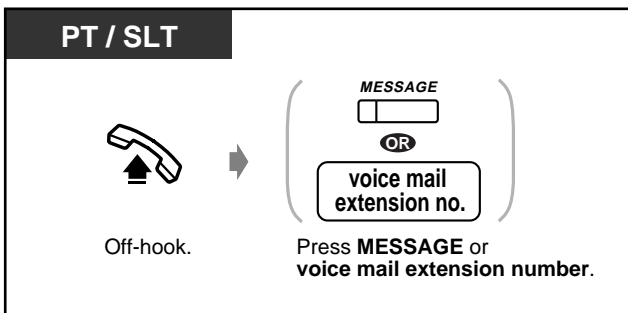

*Indication tone



Customising Your Phone

• Customising the Buttons

Create or re-arrange a MESSAGE button and Voice Mail (VM) Transfer button.

Using User-supplied Equipment

◆◆ Screening calls (Live Call Screening [LCS])

While a caller is leaving a message in your mailbox, you can monitor the call. If desired, you can answer the call while monitoring. There are two methods available (Default: Hands-free mode). In both modes, if you are currently having a conversation, you will hear a call waiting tone.



Hands-free mode: You can monitor the message automatically through the telephone speaker at the same time.

Private mode: You will hear an alert tone while the caller is leaving a message.

Before operating

- Create a Live Call Screening (LCS) button (Personal Programming).
- Select the mode, either Hands-free or Private (Personal Programming).
- Set the Password.
- Set the Live Call Screening feature.

◆ To set / cancel the password

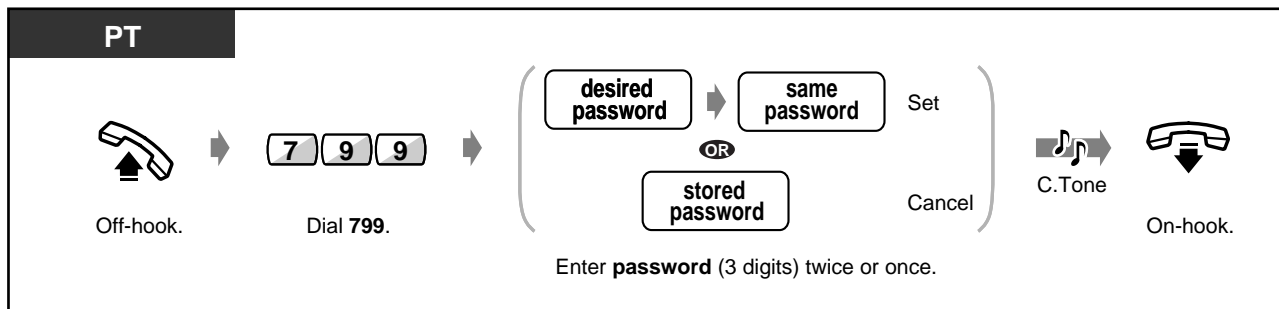

◆ To set Live Call Screening

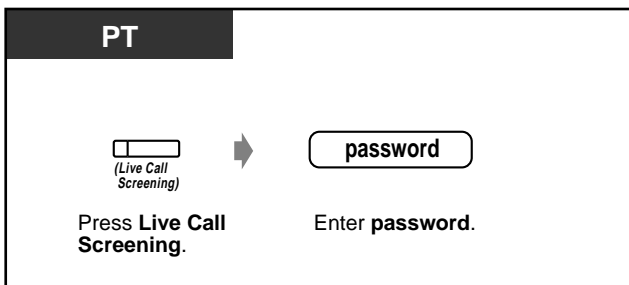

◆ To cancel Live Call Screening

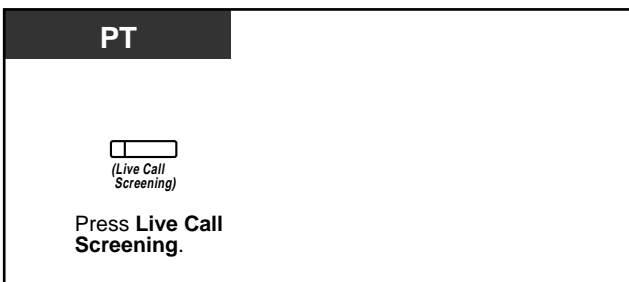



Operation Flowchart

The operations in the shaded areas can be hands-free operations.

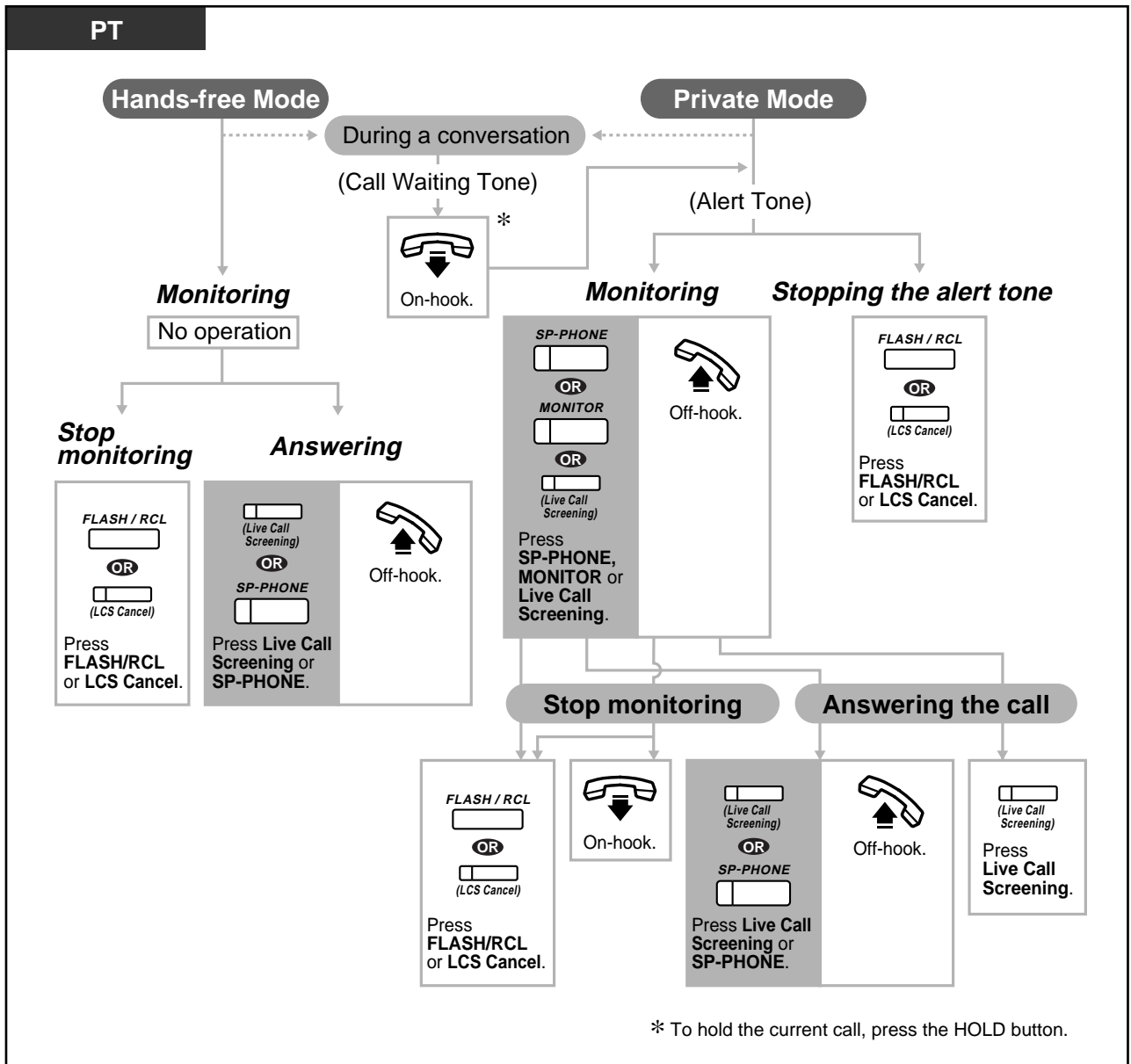

- The Live Call Screening (LCS) button light shows the feature status as follows:
 - Red on:** LCS is on.
 - Off:** LCS is off.
 - Flashing green rapidly:** Alert ringing in the Private mode*
 - Flashing green slowly:** Live Call Screening is in use.*
- * The DSS button light is red while Live Call Screening is in use.
- The operator can clear a password at any extension.



Customising Your Phone

- Initial Settings – Live Call Screening Mode Set**
Select the mode, either monitoring the message automatically or receiving alert ringing, when the caller leaves a message.
- Customising the Buttons**
Create or re-arrange a Live Call Screening button and Live Call Screening Cancel button.

Using User-supplied Equipment

◆◆ Recording a conversation (Two-Way Recording)

You can record a conversation into a mailbox while talking on the phone.



◆ To record into your mailbox

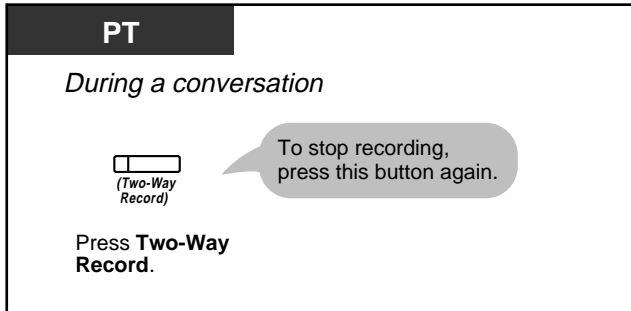

◆ To record into another mailbox

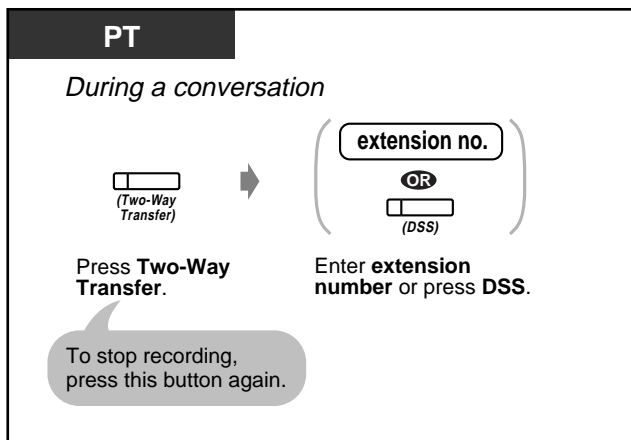

- The Two-Way Record button light shows the current status as follows:

- On:** Recording the conversation.
- Off:** Not recording.



Customising Your Phone

- **Customising the Buttons**

Create or re-arrange a Two-Way Record button and Two-Way Transfer button.



- When you record Two-Way telephone conversations, you should inform the other party that the conversation is being recorded.

Using the Display Proprietary Telephone

Calling Using the Call Log

(Incoming Call Log) [KX-T7433, KX-T7436, KX-T7230, KX-T7235 only]

If you do not answer an outside call, the caller's information is recorded automatically in the call log. When the SHIFT button light turns on, there is a call in the call log. You can also store a call log during a conversation. (See "Recording a Call Log".) Up to 15 calls can be logged per extension. You can select how the 16th call is treated; either a new call can be disregarded or a new call overwrites the oldest call. (Default: Overwrite)

You can modify and call back the logged numbers.

◆ To confirm

D – PT

While on-hook

OR

Press "OLD" or "NEW".

<Information sample>

CO02:Panasonic	-----	Outside line no. & name
012345678	-----	Phone no.
Nina Thomas	-----	Caller's name
22 09:00	-----	Receipt date & time
Seq01 2 Calls	-----	Sequence no. & calling time (max. 15)
MENU CLR NEXT		

OLD: Information you have already confirmed.
NEW: Information you have not yet confirmed.



- With the KX-T7433 and the KX-T7230, press the INFO button to scroll through information.

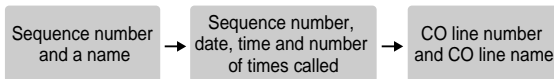

- To modify the phone no, press the "✕" key to erase and then enter the number. The number is modified from the first digit. The new number is programmed.
- To return to the initial display, press MENU button or go off-hook and on-hook.

◆ To clear the log

D – PT

Press "CLR".

Using the Display Proprietary Telephone

◆ To call back

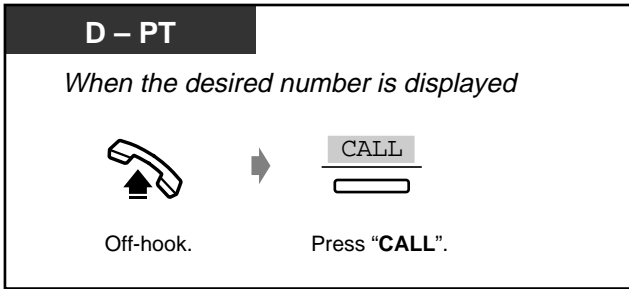

◆ How to treat the 16th call

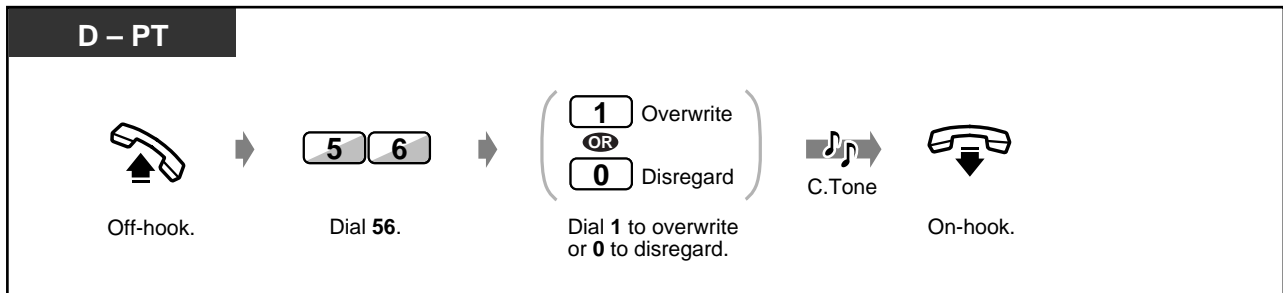



Recording a Call Log

[KX-T7433, KX-T7436, KX-T7230, KX-T7235 only]

You can record the caller's information in the call log to call them back. If you do not answer the call, the log is recorded automatically. You can see the call duration during the conversation.

◆ To record a call log

D – PT

During a conversation

LOG

Press **LOG**.

◆ To view the call duration*

D – PT

(CO)

<Display example>

CO02 12:00'30

Extension STA Speed

Features SYS Speed

Call Log

LOG

Press **CO**.



* A KX-T7433 and a KX-T7230 users may change the displayed message as follows by pressing the CO button.



Using the Display Proprietary Telephone

Denying Other People the Possibility of Seeing Your Call Log (Incoming Call Log Lock) [KX-T7433, KX-T7436, KX-T7230, KX-T7235 only]

◆ To lock / unlock

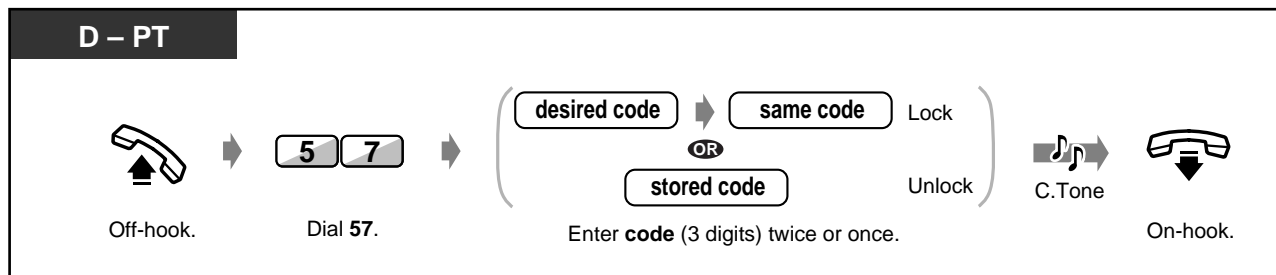

- If you forget the code, consult your operator. They can unlock the call log display of any extension (Incoming Call Log Lock Control).



Using the KX-T7431, KX-T7433, KX-T7436 or KX-T7235

- Using the KX-T7431
- Using the KX-T7433
- Using the KX-T7436

- Using the KX-T7235
- Storing the names and numbers for station speed dialling
- Display feature list

Using the KX-T7431

A KX-T7431 Panasonic proprietary telephone with a 1-line display allows you to make calls and operate the features using the display message. You do not have to memorise the phone numbers or feature numbers.

Operation

- 1 Press the MODE button repeatedly to show the desired display.
- 2 Rotate the Jog Dial until the desired message is shown.
(See page 2-93 for the feature messages.)
- 3 Press the SELECT button to call the displayed party or to select the desired feature.
- 4 Enter parameters if required.

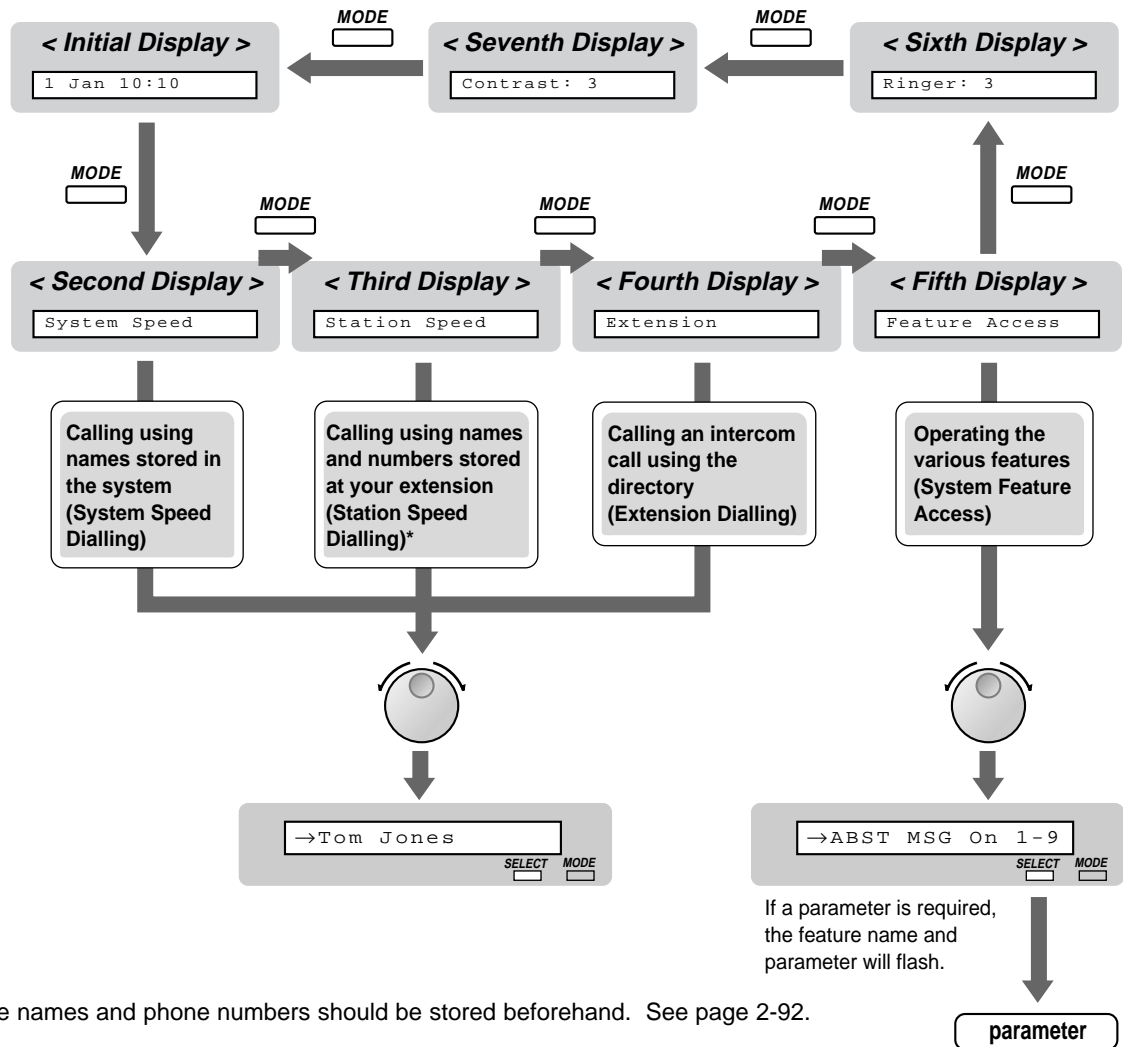

* The names and phone numbers should be stored beforehand. See page 2-92.

Using the Display Proprietary Telephone

◆◆ Using the KX-T7433

A KX-T7433 Panasonic proprietary telephone with a 3-line display allows you to make calls and operate the features using the display message. You do not have to memorise the phone numbers or feature numbers.

Operation

- 1 Press the SHIFT button repeatedly to show the third display.
- 2 Press the desired button, if required.
- 3 Rotate the Jog Dial until the desired message is at the arrow.
(See page 2-93 for the feature messages.)
- 4 Press the CALL button to call the party or the SEL button to select the desired feature.
- 5 Enter parameters if required.

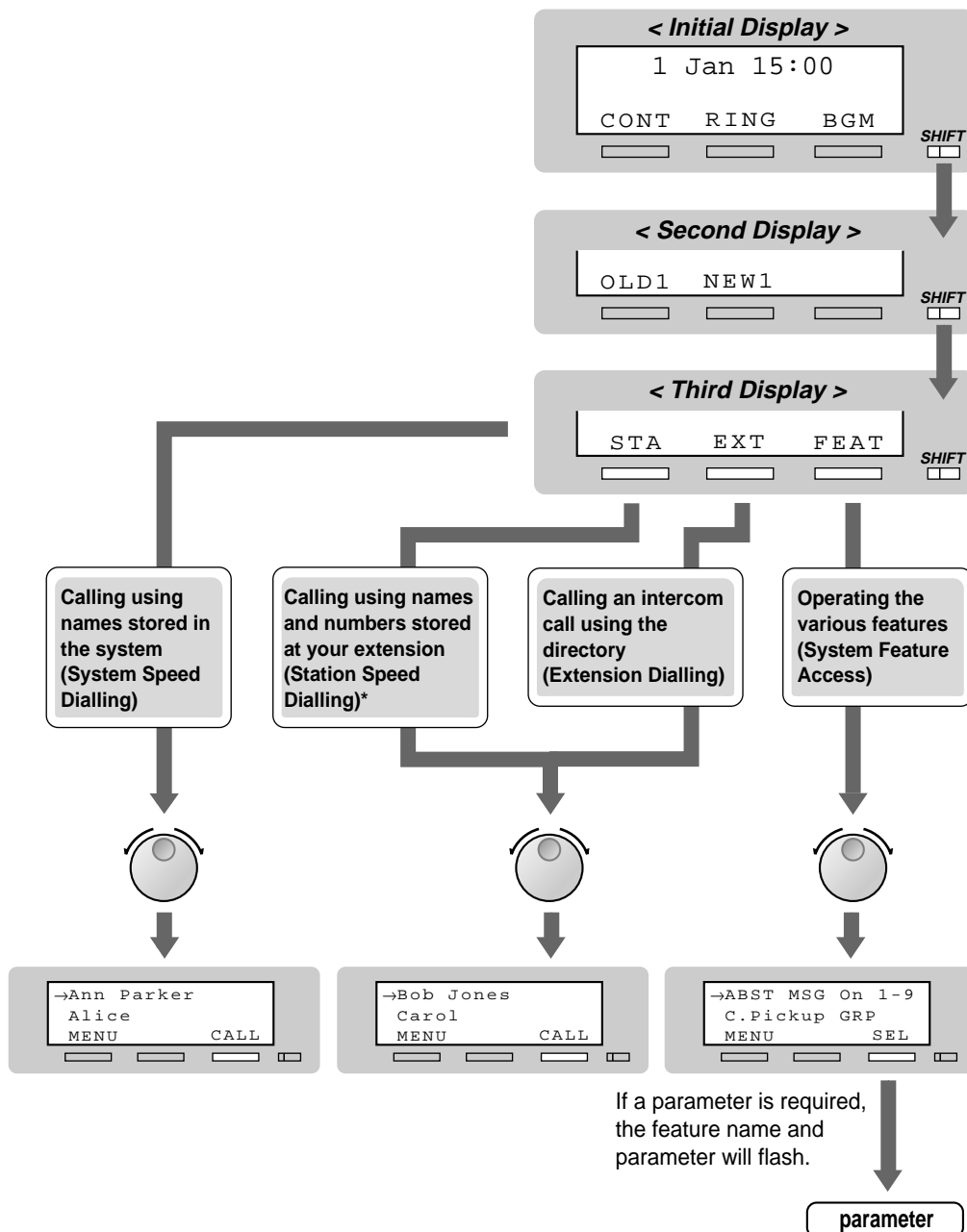

* The names and phone numbers should be stored beforehand. See page 2-92.



◆◆ Using the KX-T7436

A KX-T7436 Panasonic proprietary telephone with a 6-line display allows you to make calls and operate the features using the display message. You do not have to memorise the phone numbers or feature numbers.

Operation using the function buttons

- 1 Press the desired function button on the initial display.
- 2 Rotate the Jog Dial until the desired message is at the arrow. (See page 2-93 for the feature messages.)
- 3 Press the CALL button or the function button to call the party.
Or press the SEL button to select the desired feature at the arrow or press the function button next to the desired feature.
- 4 Enter parameters if required.

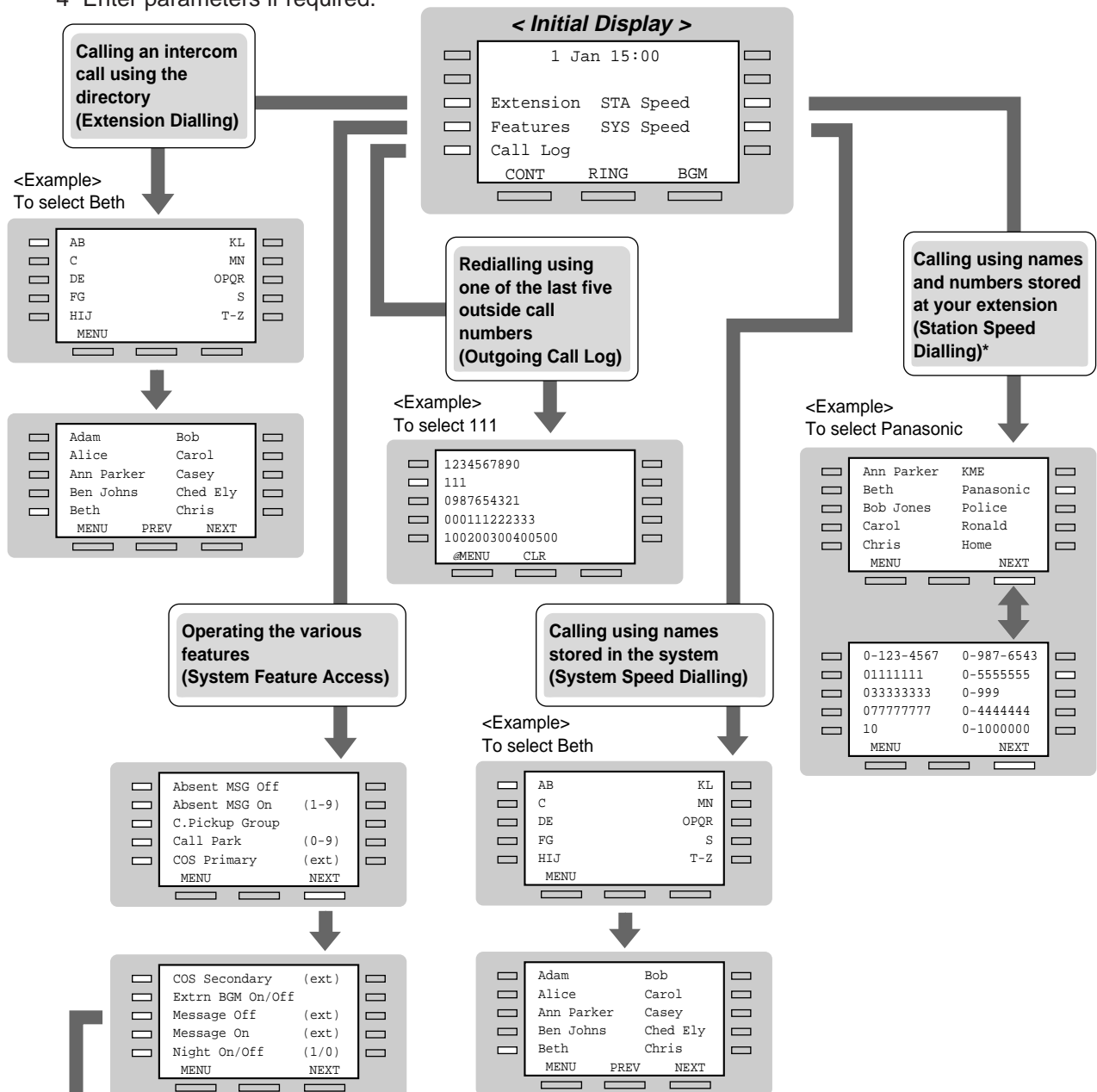

If a parameter is required, the parameter will flash.

parameter



* The names and phone numbers should be stored beforehand. See page 2-92.

Using the Display Proprietary Telephone

Operation using the soft buttons

- 1 Press the SHIFT button repeatedly to show the third display.
- 2 Press the desired button, if required.
- 3 Rotate the Jog Dial until the desired message is at the arrow.
- (See page 2-93 for the feature messages.)
- 4 Press the CALL button to call the party or the SEL button to select the desired feature.
- 5 Enter parameters if required.

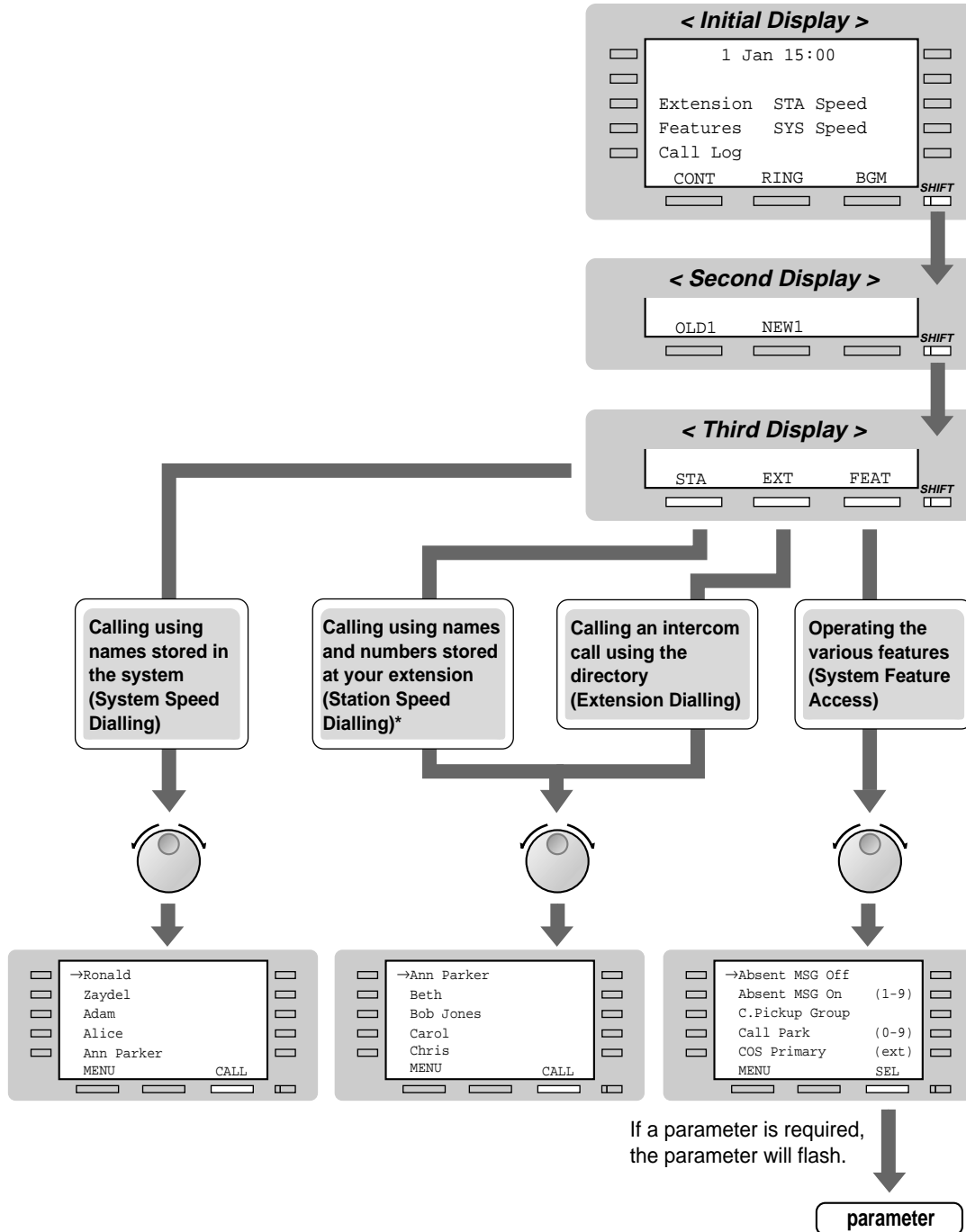

* The names and phone numbers should be stored beforehand. See page 2-92.



◆◆ Using the KX-T7235

A KX-T7235 Panasonic proprietary telephone with a 6-line display allows you to make calls and operate the features using the display message. You do not have to memorise the phone numbers or feature numbers.

Operation

- 1 Press the desired function button on the initial display.
- 2 Press the desired function button or NEXT button until the desired message is displayed. (See page 2-93 for the feature messages.)
- 3 Press the function button next to the desired party or the feature.
- 4 Enter parameters if required.

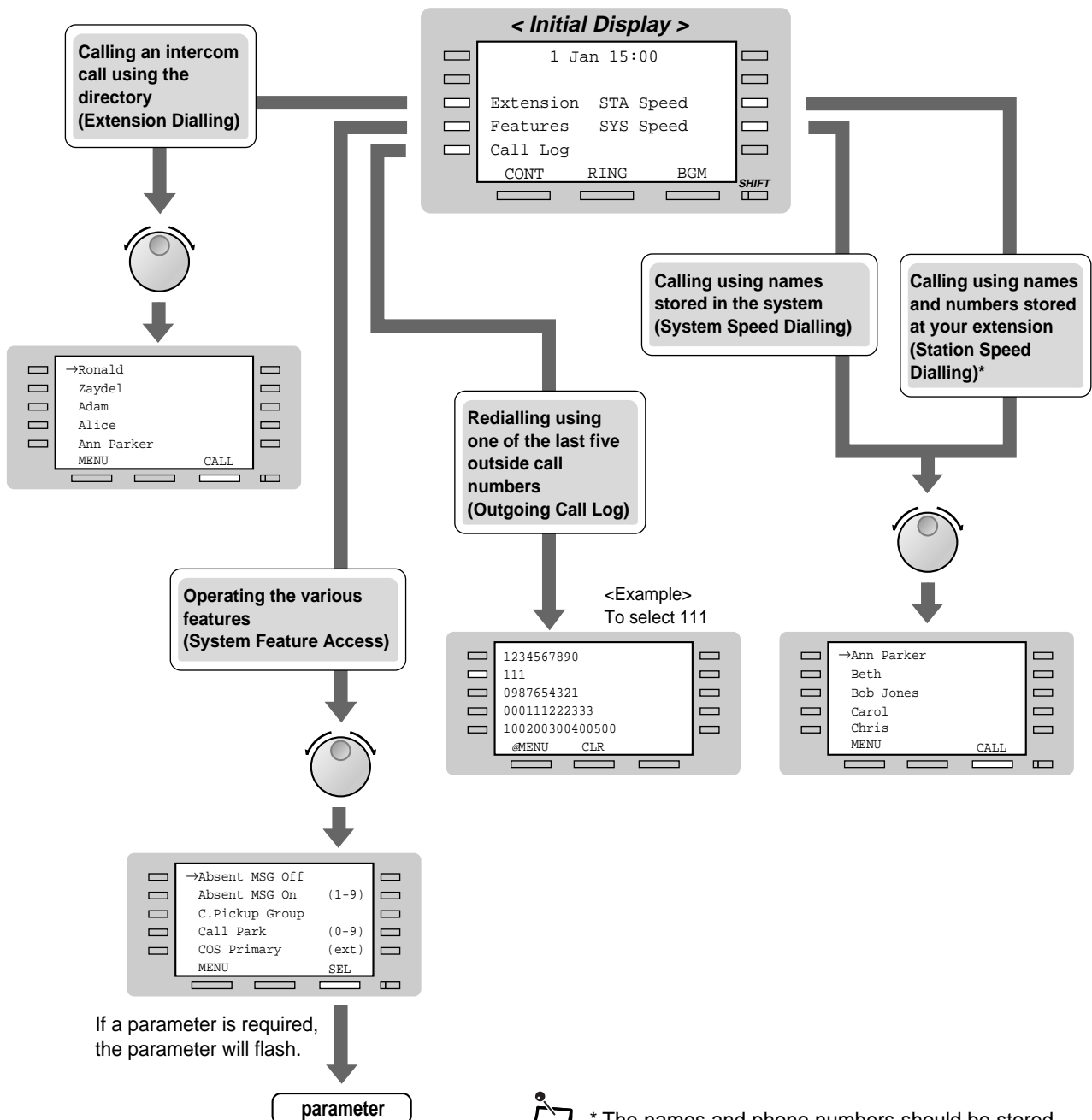

* The names and phone numbers should be stored beforehand. See page 2-92.

Using the Display Proprietary Telephone

◆◆ Storing the names and numbers for station speed dialling

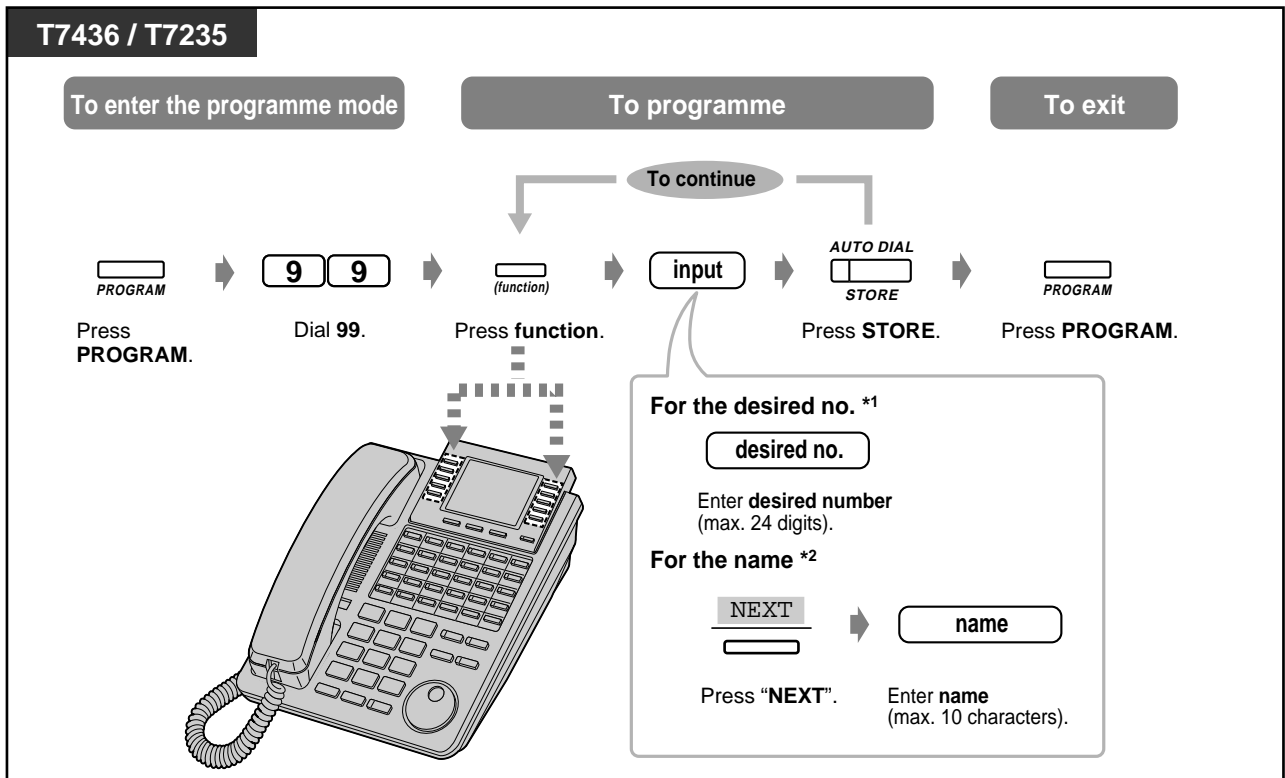
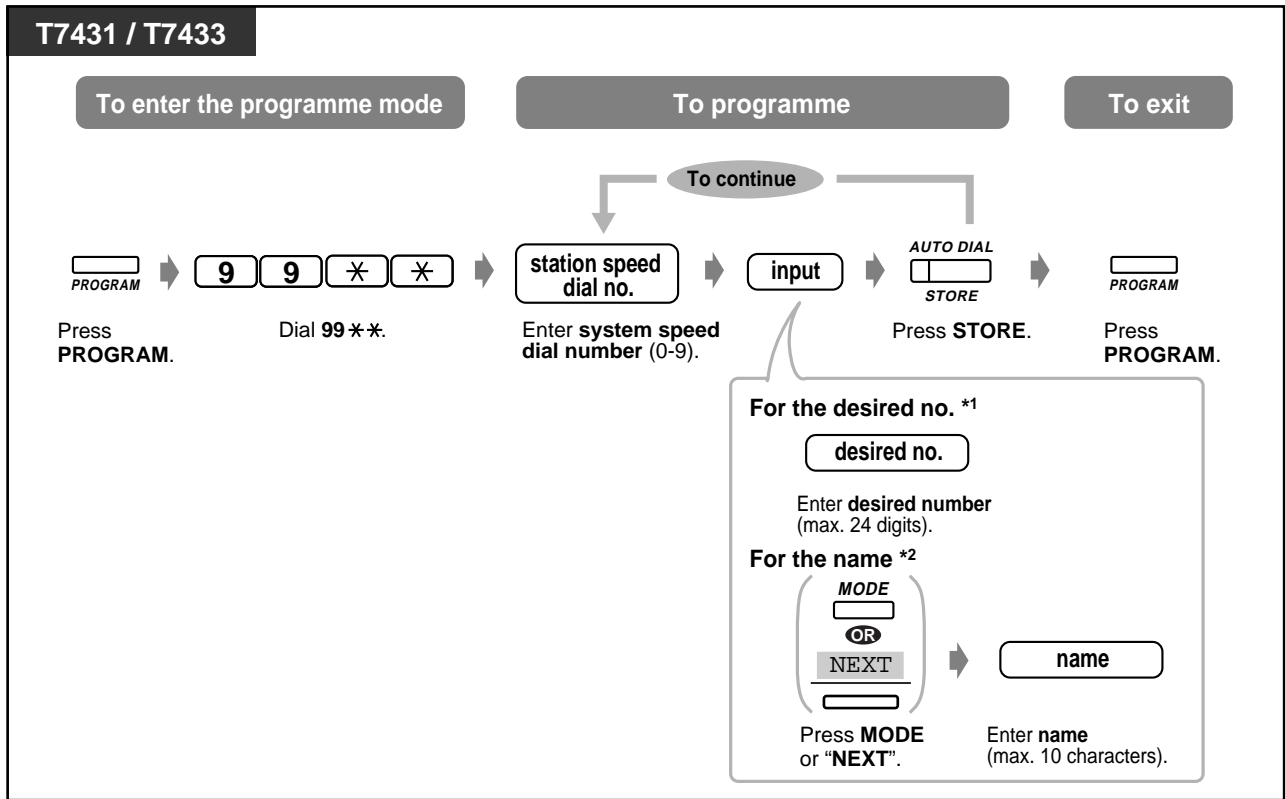

*1 " * ", "#", FLASH/RCL, PAUSE, SECRET (INTERCOM) and — (CONF) can also be stored.

*2 To enter characters, see page 4-12.



◆◆ Display feature list

You can access the following features. These displays can be shown by rotating the Jog Dial or pressing the NEXT or PREV button after selecting "Features". For their operation, see the respective operating instructions in the list below.

DISPLAY (KX-T7436/KX-T7235)	DISPLAY (KX-T7431/KX-T7433)	FEATURE DESCRIPTION
Absent MSG Off	ABST MSG Off	Cancel the absent message. Refer to 2-51.
Absent MSG On (1-9)	ABST MSG On 1-9	Set an absent message. Refer to 2-49 and 2-50.
C.Pickup Group	C.Pickup GRP	Pick up a call within your extension group. Refer to 2-27 and 2-28.
Call Park (0-9)	Call Park 0-9	Place a call on hold in a system parking area. Refer to 2-32 and 2-33.
COS Primary (ext)	COS Primary ext	Select the primary Class of Service (COS) mode for an extension*. Refer to 3-2.
COS Secondary (ext)	COS Second ext	Select the secondary Class of Service (COS) mode for an extension*. Refer to 3-2.
Extrn BGM On/Off	Ext-BGM On/Off	Turn on/off the background music.* Refer to 3-7.
Message Off (ext)	MSG Off ext	Cancel a notification. Refer to 2-19 and 2-20.
Message On (ext)	MSG On ext	Leave a notification so that the called party may call you back. Refer to 2-19 and 2-20.
Night On/Off (1/0)	Night Mode 1/0	Change the night service mode, night (On) or day (Off).* (Pre-assigned extension can also change the mode.) Refer to 3-5 and 3-6.
Page-Ext Answer (1-4)	Page-E ANS 1-4	Answer the paged announcement through a speaker. Refer to 2-29 and 2-59.
Page-GRP Answer	Page-GRP ANS	Answer the paged announcement through a telephone in the same extension group. Refer to 2-60.
Paging External (0-4)	Page Extrn 0-4	Page through the speaker. Refer to 2-54 and 2-55.
Paging Group (00-16)	Page GRP 00-16	Page to all or a particular extension group. Refer to 2-55 and 2-56.
Parallel On/Off (1/0)	Parallel 1/0	Set whether a single line telephone connected in parallel will ring (On) or not (Off) when receiving a call. Refer to 2-71.

Using the Display Proprietary Telephone



* The message is shown for the operators only.

Call Forwarding/Do Not Disturb feature:

You can also access the Call Forwarding and Do Not Disturb features. Go off-hook and press the FWD/DND button. You will see the following displays. For their operation, see the respective operating instructions. The KX-T7436 and the KX-T7235 users only use this display operation.

FWD/DND Cancel
DND (→0/*/ext)
FWD-All Calls (→ext)
FWD-Busy (→ext)
FWD-No Answer (→ext)
MENU PREV NEXT

FWD-BSY/NA (→ext)
FWD-CO Line (→dial)
FWD-From (→ext)
FWD-From Cancel (→ext)
MENU PREV NEXT

3

Operator Operation

This chapter shows the operators how to control the extensions or the system.

Your system supports up to two operators.

Extension Control

Assigning Level of Service

You can assign either primary or secondary level of service for each extension.

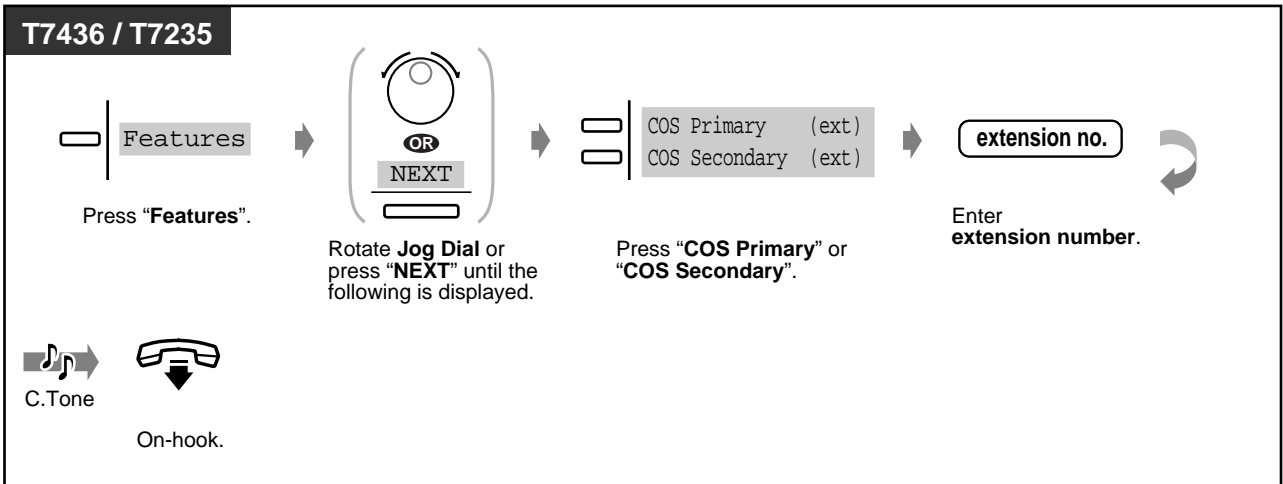
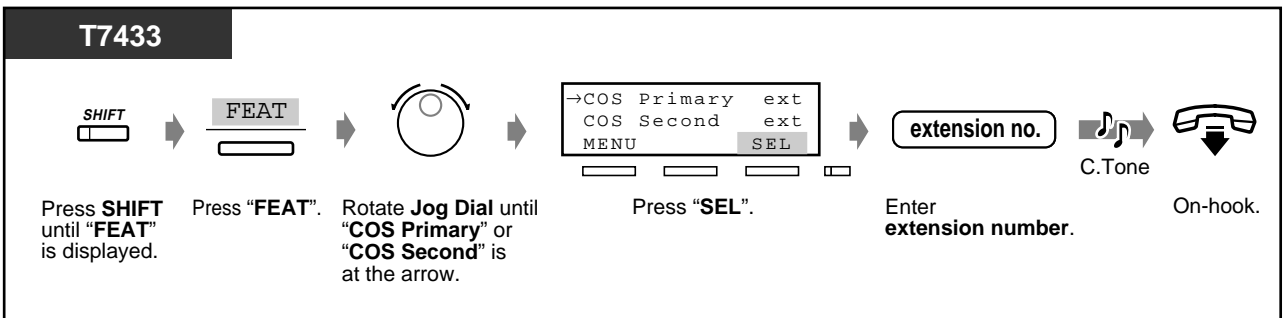
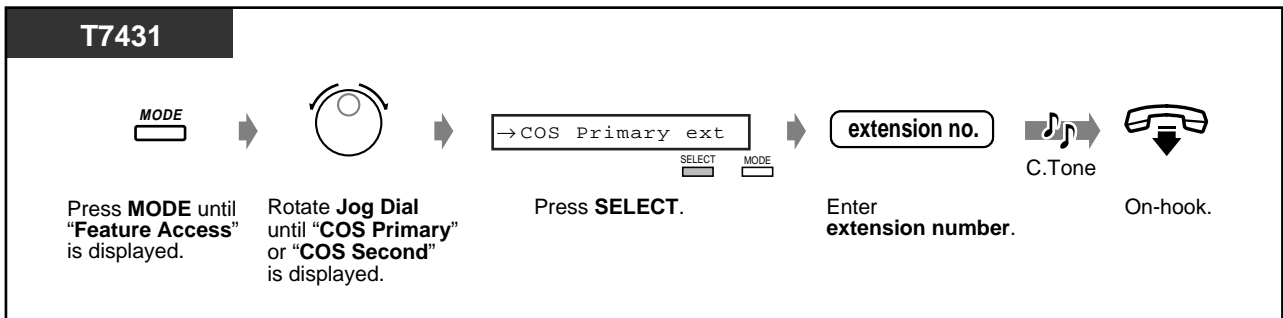
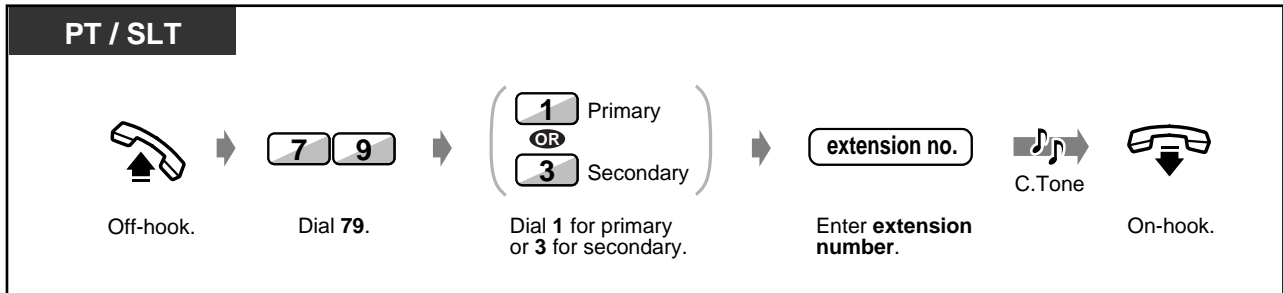

Changing the Settings

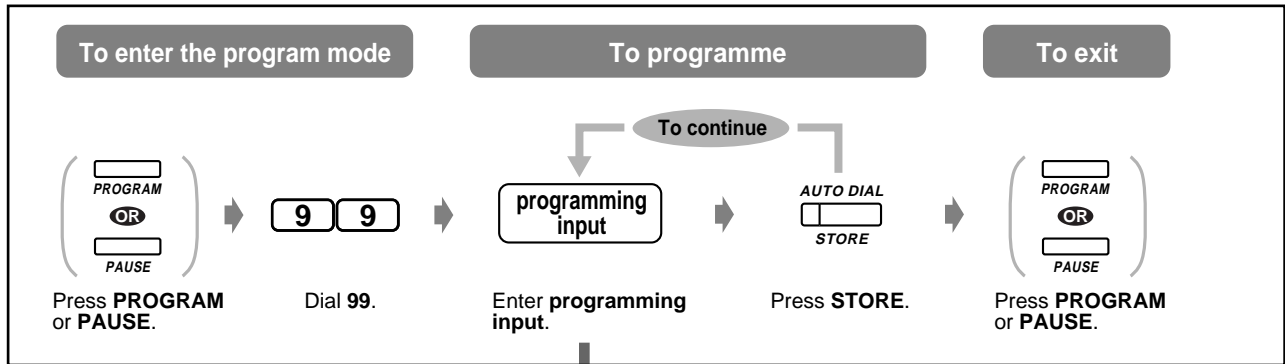

Item	Programming Input
Unlocking or locking any extension (Remote Station Lock Control)	0 1 extension no.* X X= 1 : Unlock 2 : Lock
Unlocking the call log (Incoming Call Log Lock Control)	0 2 extension no.*
Clearing the Live Call Screening Password (Live Call Screening Password Control)	0 3 extension no.*



* To assign all extensions, press the “*” key.

System Control

Forwarding a Waiting Call (Automatic Overflow / Hurry-up Transfer)

When you (operator 1) are busy and an outside call comes to you directly, that call is put in a waiting queue. When the number of calls in the queue exceeds the assigned limit, calls will automatically be forwarded to operator 2. You can check the condition of the queue with the Hurry-Up button light, and forward the first call in the queue to a pre-assigned extension.



◆ **To forward**

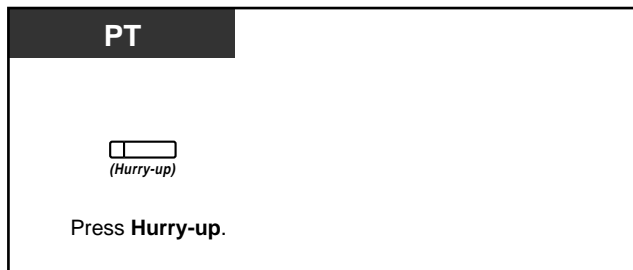

- The Hurry-Up button light shows the current status as follows:
 - Off:** No waiting call
 - Red:** At least one call is waiting.
 - Flashing red:** Number of calls exceeds assigned limit.



Customising Your Phone

- **Customising Your Phone**
 - Create or re-arrange a Hurry-Up button.



Day / Night Service

You can change the Day/Night mode at any time.

PT / SLT

Off-hook. Dial 78. Dial 1 for day to night or 0 for night to day. C.Tone On-hook.

T7431

Press **MODE** until "Feature Access" is displayed. Rotate **Jog Dial** until "Night Mode" is displayed. Press **SELECT**. Dial 1 for day to night or 0 for night to day. C.Tone On-hook.

T7433

Press **SHIFT** until "FEAT" is displayed. Press "FEAT". Rotate **Jog Dial** until "Night Mode" is at the arrow. Press "SEL". Dial 1 for day to night or 0 for night to day. C.Tone On-hook.

Operator

System Control

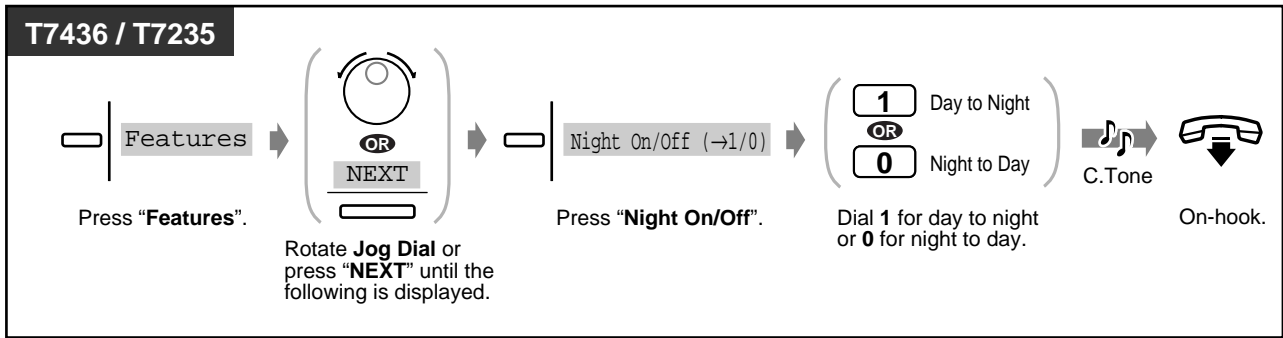

- The Night button alternates the setting between Day and Night modes.
- **To confirm the current mode**, press the "#" key while on-hook.
- The Night button light shows the current status as follows:
 - Off**: Day mode
 - Red**: Night mode
- Pre-assigned extension user can also change the mode.



Customising Your Phone

- **Customising the Buttons**

Create or re-arrange a Night button.



Turning on the External Background Music

PT / SLT

Off-hook. Dial **65**. C.Tone On-hook.

T7431

Press **MODE** until "Feature Access" is displayed. Rotate **Jog Dial** until "Ext-BGM On/Off" is displayed. Press **SELECT**. C.Tone On-hook.

T7433

Press **SHIFT** until "FEAT" is displayed. Press "FEAT". Rotate **Jog Dial** until "Ext-BGM On/Off" is at the arrow. Press "SEL". C.Tone On-hook.

T7436 / T7235

Press "Features". Rotate **Jog Dial** or press "NEXT" until the following is displayed. Press "Extrn BGM On/Off". C.Tone On-hook.

System Control

Recording Outgoing Messages

UCD messages : Used for the greeting message or guidance when an external party calls your company to access an extension or external party without any operator assistance. Up to four different UCD messages can be recorded.

Timed Reminder message : Often used as wake-up call which is played when answering the Timed Reminder alarm. Only one Timed Reminder message can be recorded.
You can also play back the recorded message for confirmation.

◆ To record

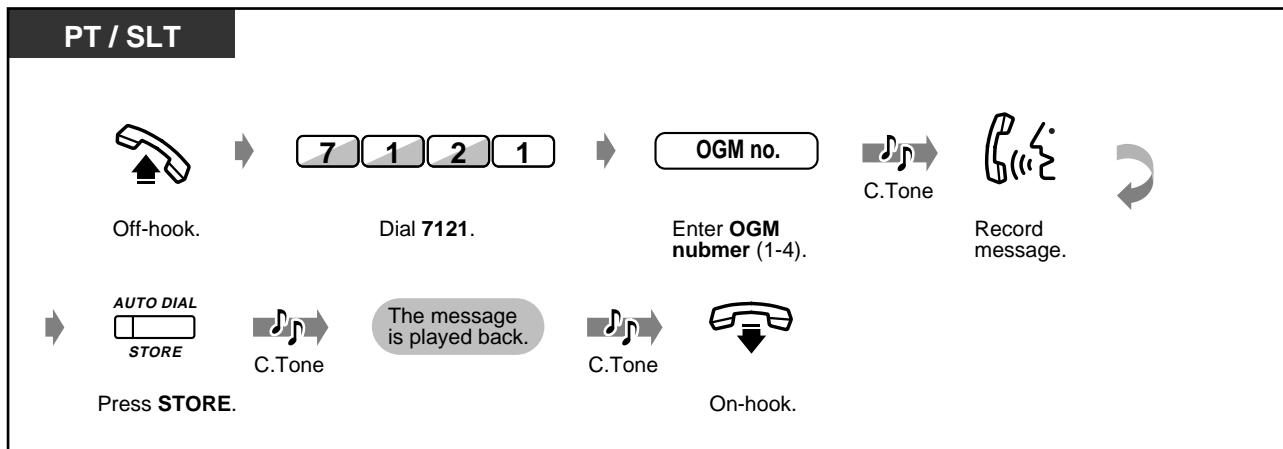

◆ To play back

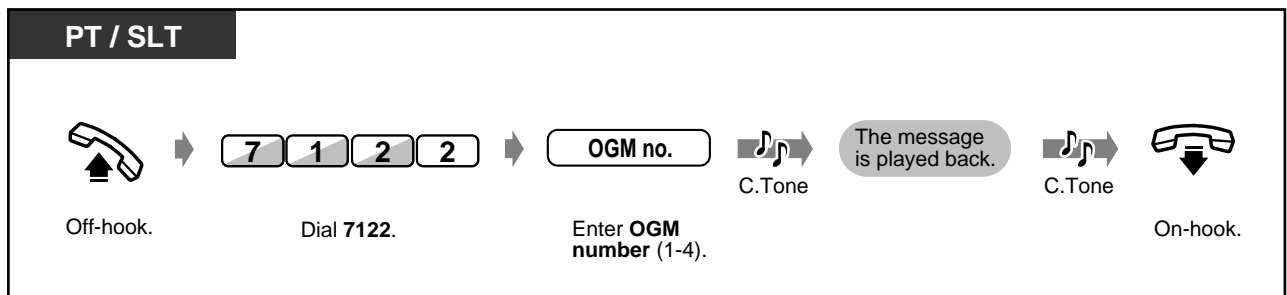

• To stop recording or playing back, press the AUTO DIAL / STORE button.

• **Message recording limit**

The total length must be under sixty four seconds or less. (Default: 32 seconds for OGM 1 and 3 and 0 second for OGM 2 and 4)



Using the ANSWER / RELEASE Button

[KX-T7441 only]

The ANSWER and RELEASE buttons on the Console are convenient for operators using headsets. With the ANSWER button, you can answer all incoming calls to the paired telephone. With the RELEASE button, you can disconnect the line during or after a conversation, or complete transferring a call.

◆ To answer

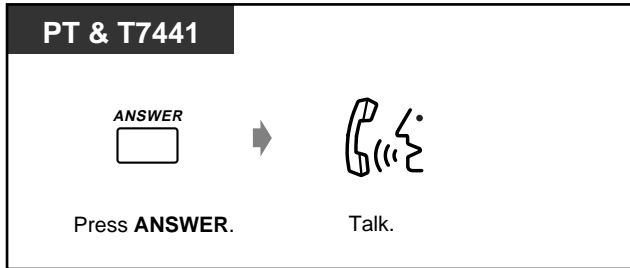

◆ To transfer a call

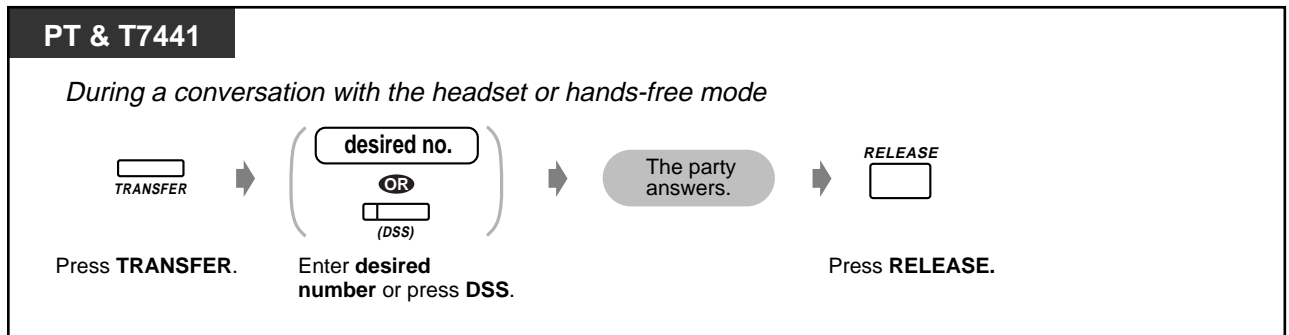

◆ To transfer an outside call to an extension with one-touch

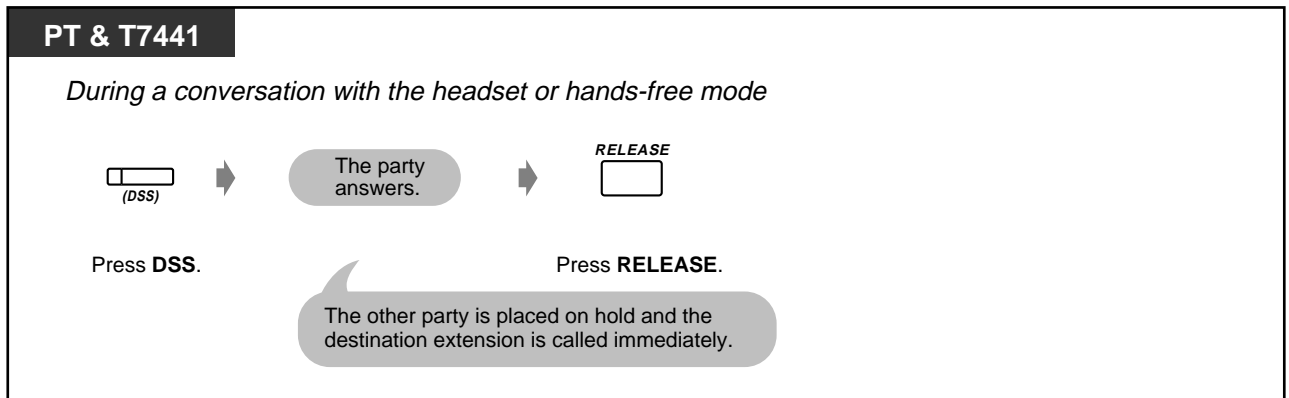

System Control

Hotel Use Features

- Check-in / check-out
- Unanswered timed reminder alert
- Setting the alarm for other extensions
- Printing out guest room information

◆◆ Check-in / check-out [KX-T7436, KX-T7235 only]

The check-in mode activates the primary service mode and automatically clears the charge counter. The check-out mode activates the secondary service mode and prints out the charge counter, minibar and other expenses. While in the check-in mode, the DSS button light turns on.

◆ To check-in

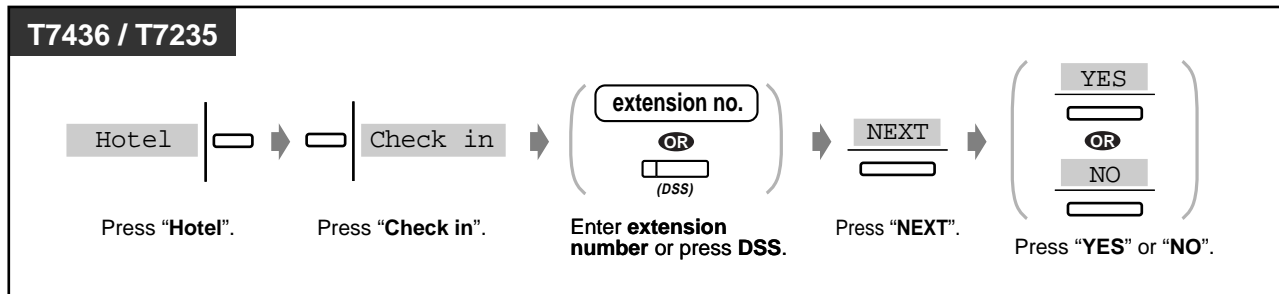

◆ To check-out

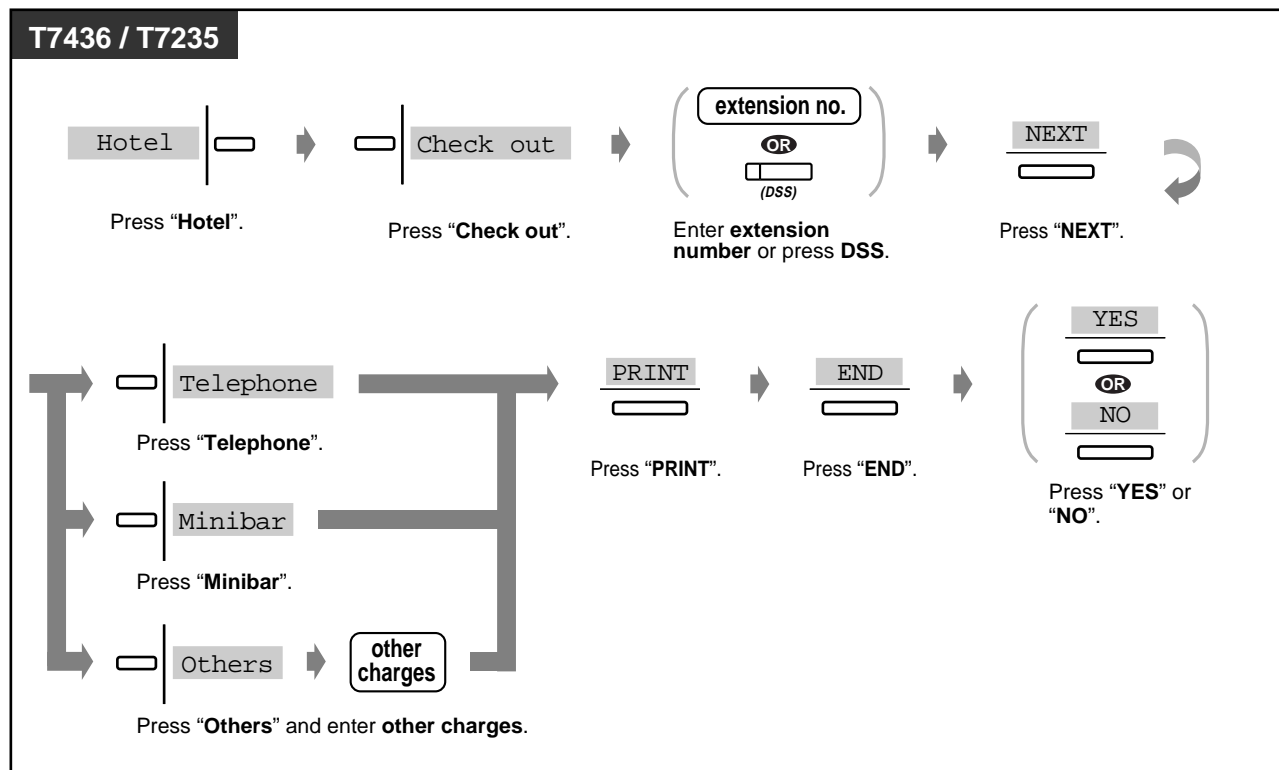

- It is possible to change the telephone and minibar charges. In this case, enter the charge after pressing the "Telephone" or "Minibar" button.



Data similar to below is printed out.

<i>Check in : 30.Jan.99 05:30 PM</i>			
<i>Check out : 31.Jan.99 11:15 AM</i>			
<i>Room : 201</i>			
<i>Telephone</i>	<i>11.22 (Tax</i>	<i>0.0%=</i>	<i>0.0)</i>
<i>Minibar</i>	<i>44.33 (Tax</i>	<i>0.0%=</i>	<i>0.0)</i>
<i>Others</i>	<i>55.00 (Tax</i>	<i>0.0%=</i>	<i>0.0)</i>
<i>Total</i>	<i>£ 110.55 (Tax</i>	<i>0.0%=</i>	<i>0.0)</i>

◆◆ **Unanswered timed reminder alert [KX-T7436, KX-T7235 only]**

If the guest does not answer a wake-up call, the Alert button light will flash. Pressing the Alert button informs you which extension did not answer the wake-up call.

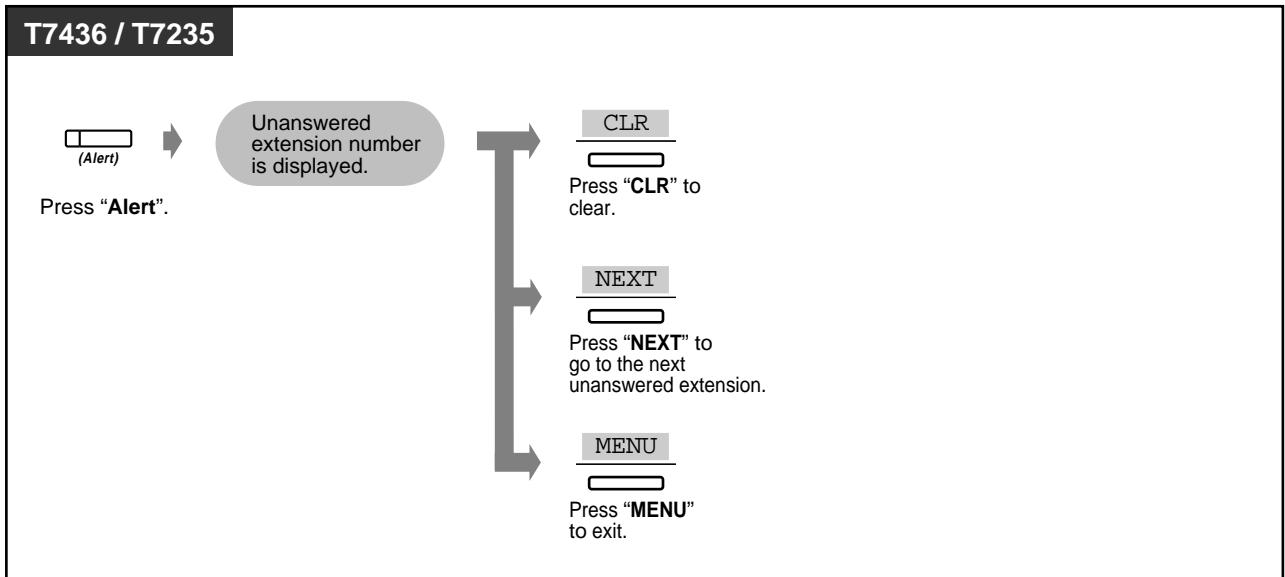

Customising Your Phone

- **Customising the Buttons**
Create or re-arrange an Alert button.

System Control

◆◆ Setting the alarm for other extensions (Wake-up Call)

◆ To set

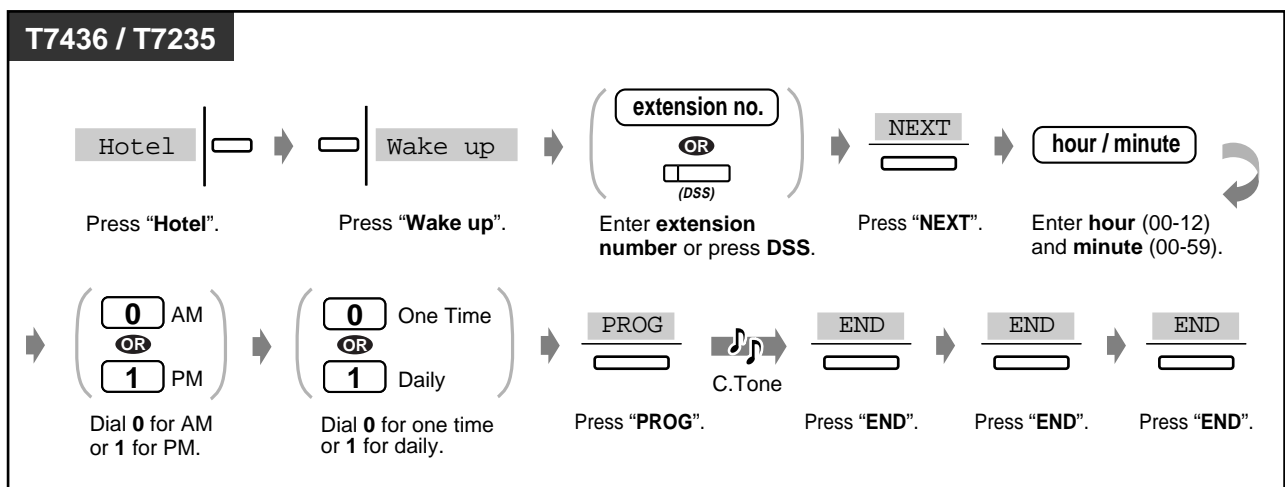
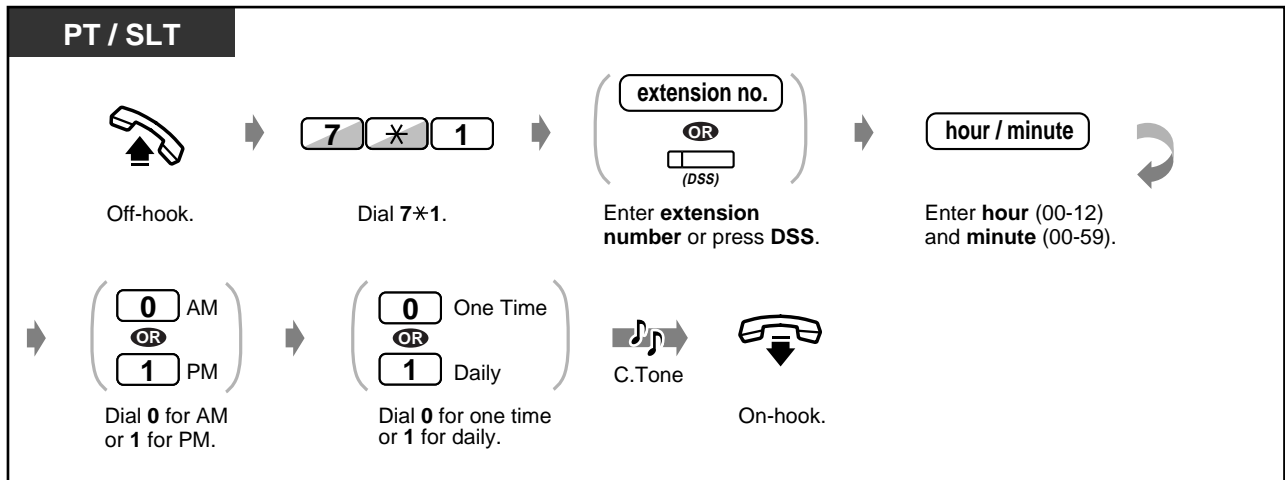

• A voice message can be recorded by the operator if required. (Refer to "Recording Outgoing Messages".)

◆ To cancel

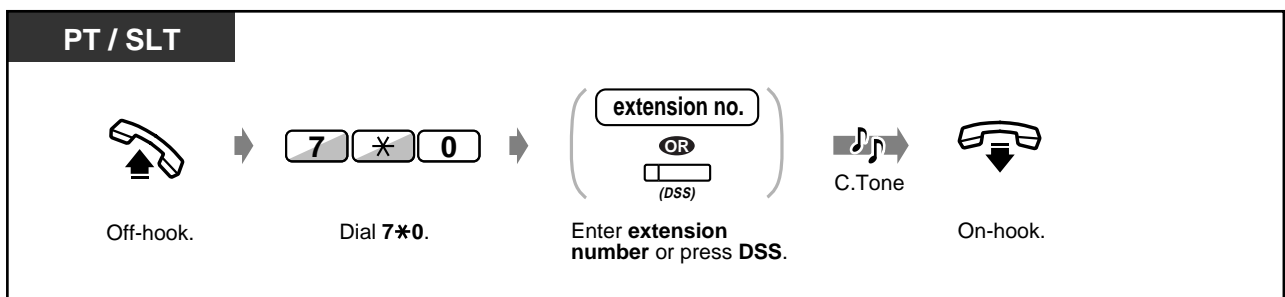

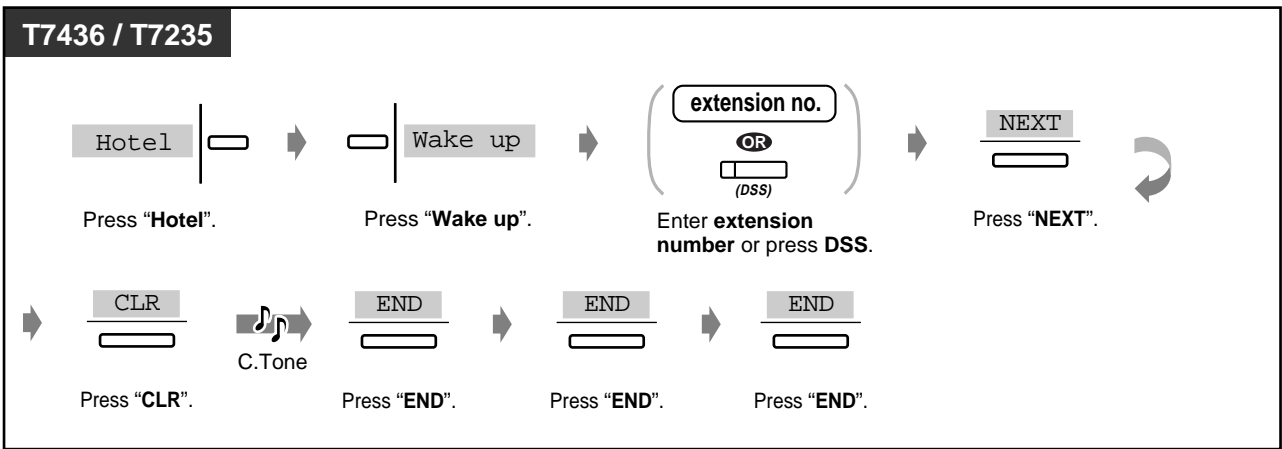

◆ **To view the setting**

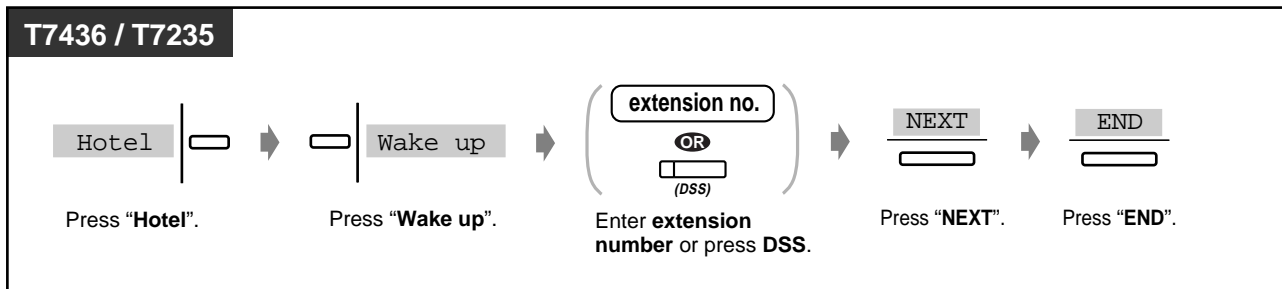
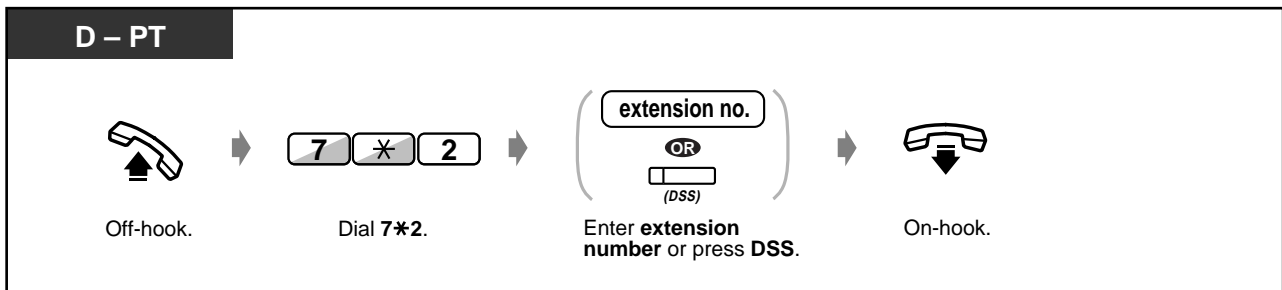

!!

- If the daily alarm is set, the display shows "*" in the corner.

Alarm 10:10AM*

System Control

◆◆ Printing out guest room information

Guest room information can be printed out from the telephone in each room. Pre-assigned message numbers 6 through 9 can be used.

<Example>

Message 6: "Cleaned-up"

Message 7: "Minibar £ %%%.%"

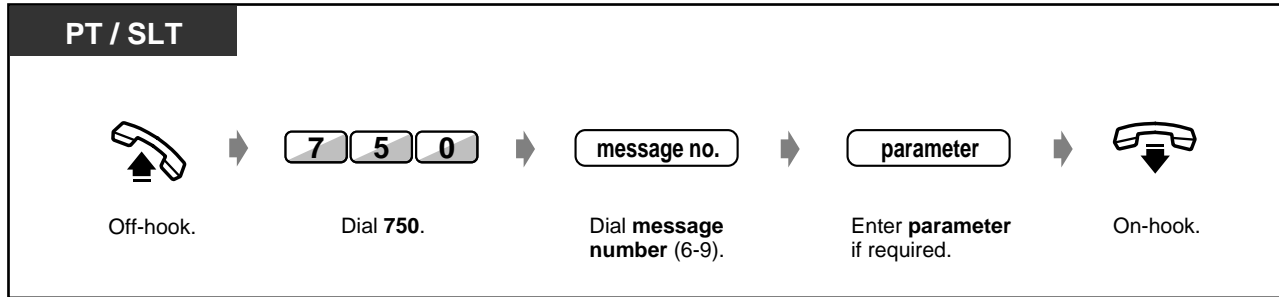

Data similar to below is printed out.

Date	Time	Ext	Department code	CO	Dial Number	Duration	Charge	Code	CD
24.03.99	02:09 PM	221			Cleaned-up				
24.03.99	10:23 AM	230			Minibar £ 53.5				



Printing the System Working Report

The system working report contains the following:

- The number of incoming calls and answered calls
- The percentage of answered calls versus all incoming calls
- The number of accesses requested and successful calls
- The percentage of successful calls versus tries
- The average call duration

This report can also be printed out by the manager.

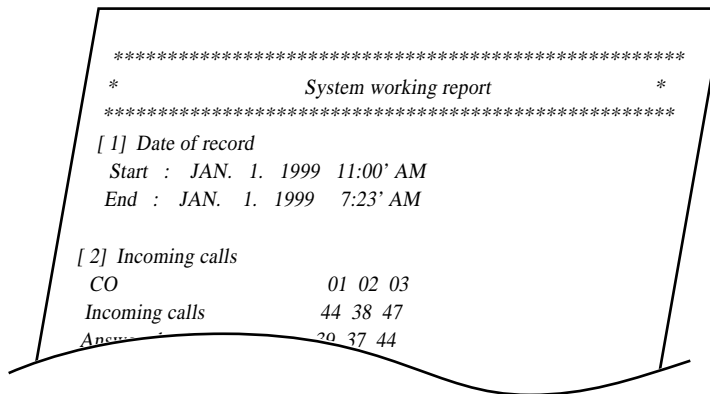
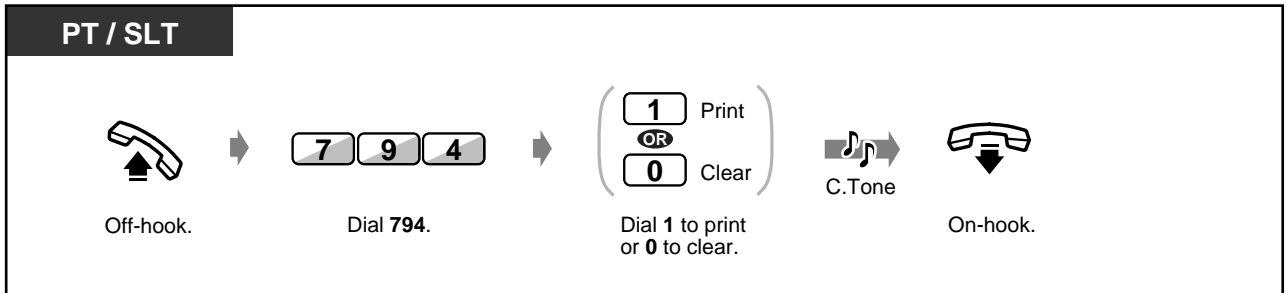

4

Customising Your Phone & System

This chapter shows you how to customise your individual telephone or system according to your needs.

Find the desired setting and program as necessary.



Customising Your Phone (Station Programming)

If you use a Panasonic proprietary telephone (e.g. KX-T7436), you can customise your telephone functions. For example, you can change the initial settings or button functions according to your needs.



• If you change your desks and the extension line, clear all settings first. The old settings will remain in the previous extension user's memory.

Initial Settings

The original settings are shown in bold letters in the shaded boxes. Find and mark your desired selections for programming.



- If nothing is entered within one minute in the programming mode, the mode returns to the normal status.
- To exit the mode at any time, lift the handset.

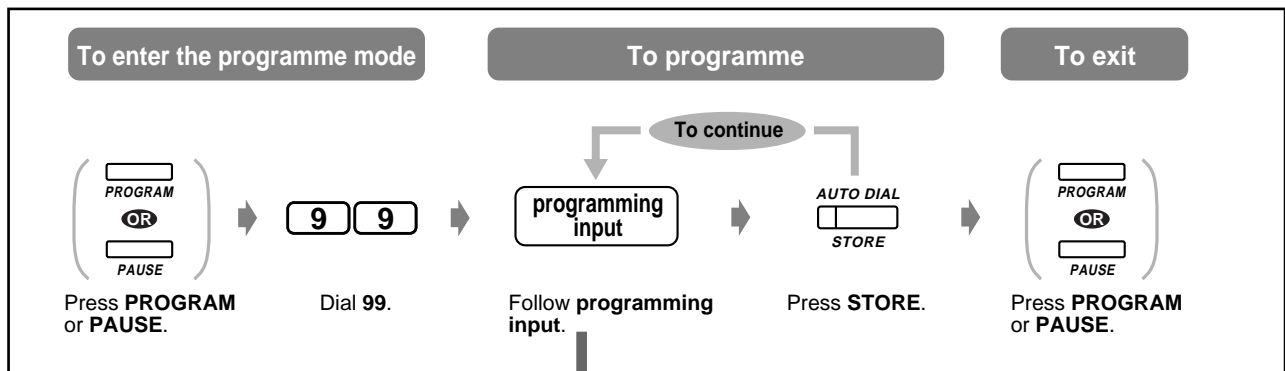

Item	Selection	Programming Input
Which line do you prefer to seize when you go off-hook to make calls? (Preferred Line Assignment – Outgoing)	<input type="checkbox"/> No line	1 1
	<input type="checkbox"/> An idle outside line	1 2
	<input type="checkbox"/> A pre-assigned outside line	1 3 Outside line no. (01–54)
	<input checked="" type="checkbox"/> The Intercom line	1 INTERCOM
Which line do you prefer to seize when you go off-hook to receive calls? (Preferred Line Assignment – Incoming)	<input type="checkbox"/> No line	2 1
	<input checked="" type="checkbox"/> A ringing line	2 2
	<input type="checkbox"/> A pre-assigned outside line	2 3 Outside line no. (01–54)



Item	Selection	Programming Input
Which way do you prefer to dial the One-Touch Dialling feature? (Full One-Touch Dialling Assignment)	<input type="checkbox"/> Going Off-hook and then pressing the One-Touch Dialling button.	3 1
	<input checked="" type="checkbox"/> Pressing the One-Touch Dialling button.	3 2
Which way do you prefer to receive an intercom call? (Intercom Alert Assignment)	<input checked="" type="checkbox"/> Ringing	4 1
	<input type="checkbox"/> Directly – the party's voice is heard without ringing.	4 2
Do you prefer to distinguish the Call Waiting tone from an outside line and an intercom call? (Call Waiting Tone Type Selection)	<input checked="" type="checkbox"/> No. Use the same tone.	5 1
	<input type="checkbox"/> Yes. Use a different tone.	5 2
Which equipment will you use as a receiver? (Handset/Headset Selection)	<input checked="" type="checkbox"/> Handset	9 1
	<input type="checkbox"/> Headset	9 2
Which voice mail service do you prefer when a caller is recording a message in your mailbox? (Live Call Screening Mode Set)	<input checked="" type="checkbox"/> You can monitor the message through the telephone speaker. (Hands-free mode)	* 1 1
	<input type="checkbox"/> Only an alert tone is heard. (Private mode)	* 1 2

◆◆ To confirm the current setting

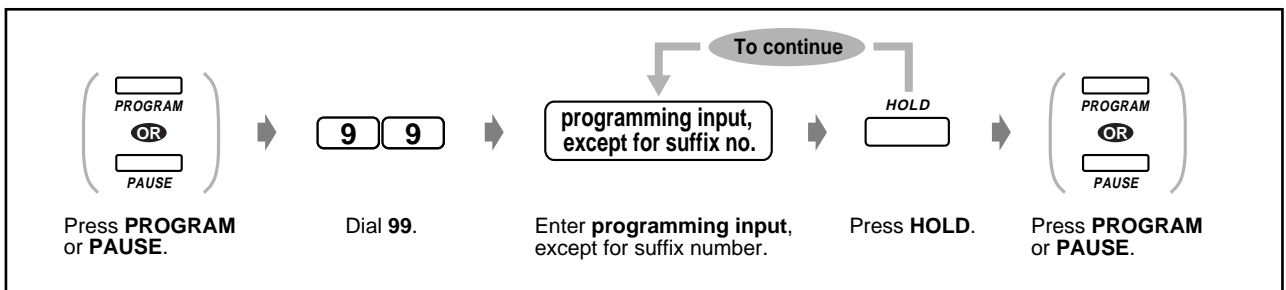

◆◆ To clear all settings

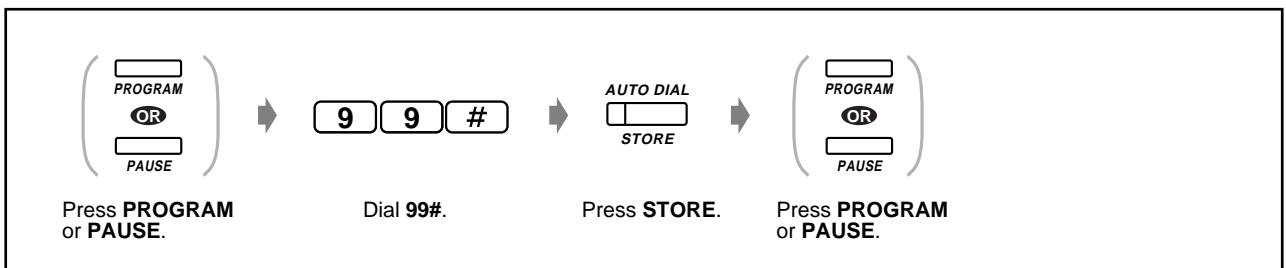

Customising Your Phone (Station Programming)

Customising the Buttons

You can change the flexible CO buttons, DSS buttons and programmable function (PF) buttons to the following function buttons. For example, if your telephone has more CO buttons than available CO lines, you may change an unused CO button to a one-touch dialling button.

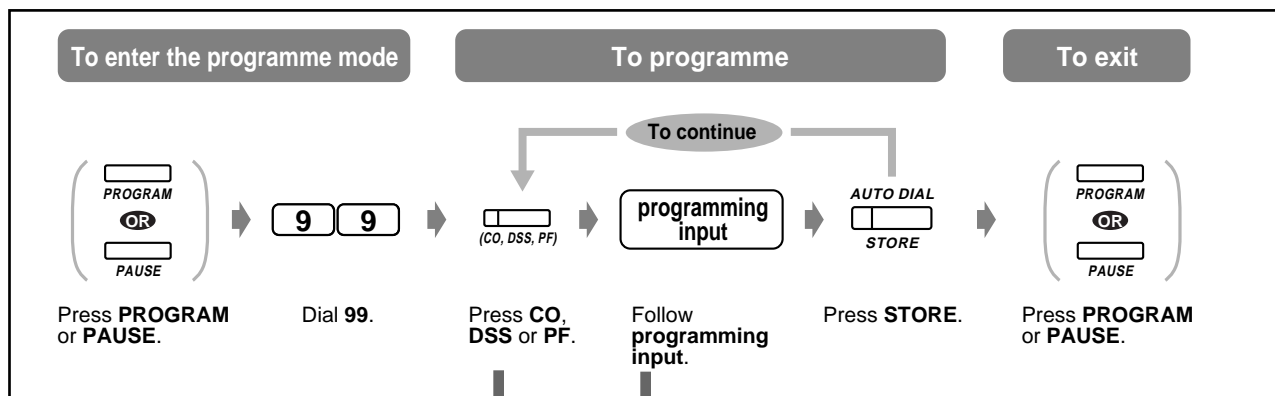

Button	Programmable Button			Programming Input
	CO	DSS	PF	
Loop-CO	✓			*
Group-CO	✓			# Outside line group no. (1–8)
Single-CO	✓			0 Outside line no. (01–54)
Direct Station Selection (DSS)	✓	✓		1 Extension no.
One-Touch Dialling	✓	✓	✓	2 Desired no. ¹ (max. 24 digits)
MESSAGE	✓	✓		3
FWD/DND (Forward/Do Not Disturb)	✓	✓	✓	4
SAVE	✓	✓	✓	5
Account	✓	✓	✓	6
CONF (Conference)	✓	✓	✓	7
Log-In/Log-Out* ²	✓			8 0 Receiving group no.
Hurry-Up	✓			8 1 Extension no.
Voice Mail Transfer* ³	✓	✓	✓	8 2 Voice mail extension no.
Two-Way Record* ³	✓	✓		8 3 Voice mail extension no.
Two-Way Transfer* ³	✓	✓		8 4 Voice mail extension no.
Live Call Screening* ³	✓	✓		8 5
Live Call Screening Cancel* ³	✓	✓		8 6
Alert	✓			8 7



Button	Programmable Button			Programming Input	
	CO	DSS	PF		
Phantom Extension	✓	✓		8 8	Phantom extension no.
Night* ²	✓	✓		8 * 0 0	
Call Pickup Deny* ²	✓	✓		8 * 0 1	
Call Waiting* ⁴	✓	✓		8 * 0 2	
Calling Line Identification Restriction (CLIR)* ²	✓	✓		8 * 0 3	
Connected Line Identification Restriction (COLR)* ²	✓	✓		8 * 0 4	
Do Not Disturb for Direct Dialling In Call (DND for DDI)* ²	✓	✓		8 * 0 5	
Paging Deny* ²	✓	✓		8 * 0 7	
Paralleled Telephone Connection* ²	✓	✓		8 * 0 8	
Pickup Dialling* ²	✓	✓		8 * 0 9	
Call Forwarding from Hunting Group* ²	✓	✓		8 * 1 0	Forwarding receiving group no.
Doorphone Call Forwarding to Outside Line* ²	✓	✓		8 * 1 1	Doorphone no. (1–4)
One-Touch Dialling with Auto Hold	✓	✓		8 #	Desired no.* ¹ (max. 24 digits)
Terminate	✓	✓	✓	9	



- *¹ “ * ”, “ # ”, FLASH/RCL, PAUSE, SECRET (INTERCOM) and — (CONF) can also be stored.
 - If you do not want to display the stored number, press the SECRET (INTERCOM) button before and after the numbers you wish to conceal.
 - If you store an external party’s number, you should first store a line access number (9, 81 to 88).
 - If you need to enter an account code, you can enter the specified account code before the line access number.

<Example>

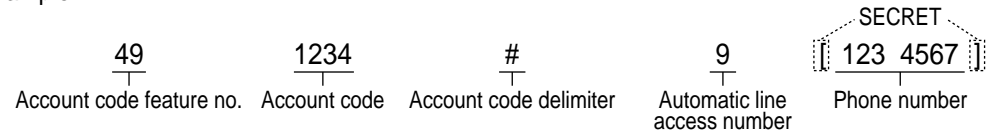

- *² Pressing these button alternates the on / off setting of the corresponding feature.
- *³ These buttons are used for the voice mail integration feature.
- *⁴ Pressing this button changes the settings as follows.

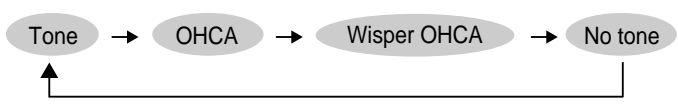

- **To exit the mode at any time**, lift the handset.

Customising Your Phone (Station Programming)

- ◆◆ **To distinguish the ringing tones for each CO button**
(Digital proprietary telephone only)

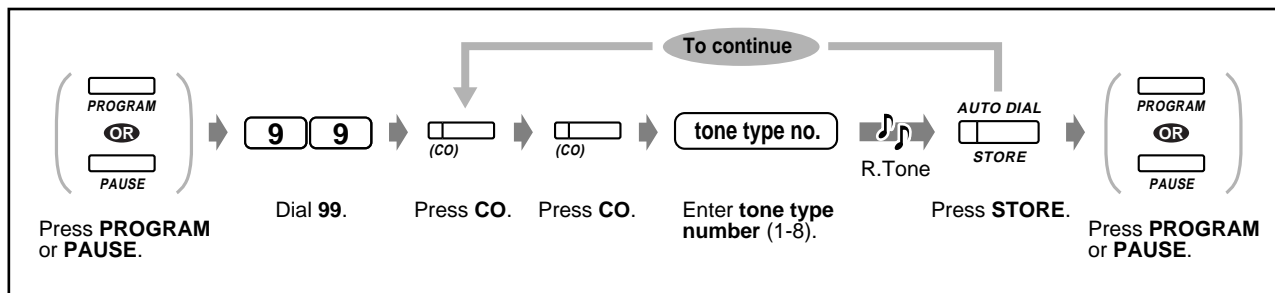

- ◆◆ **To change the ringing tone for intercom calls**
(Digital proprietary telephone only)

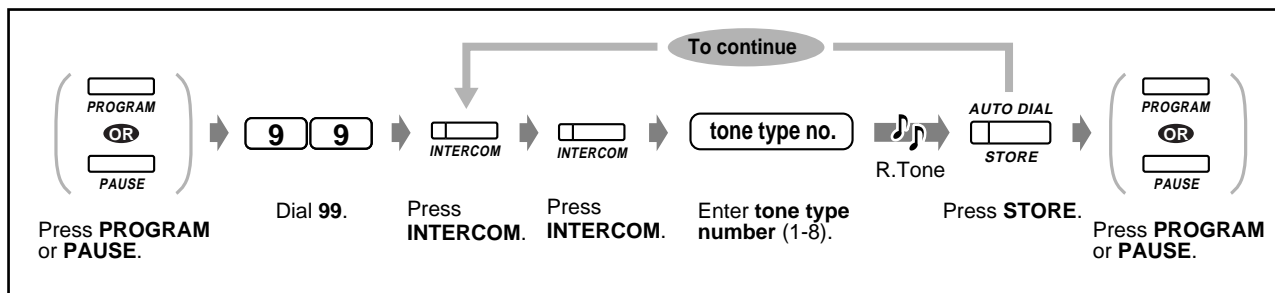

- ◆◆ **To set a phantom extension ringing or not**
(Digital Proprietary telephone only)

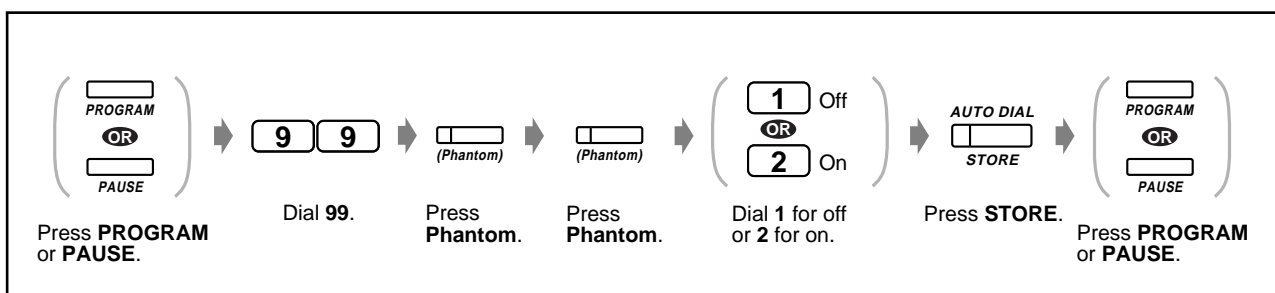

- ◆◆ **To clear the button data**

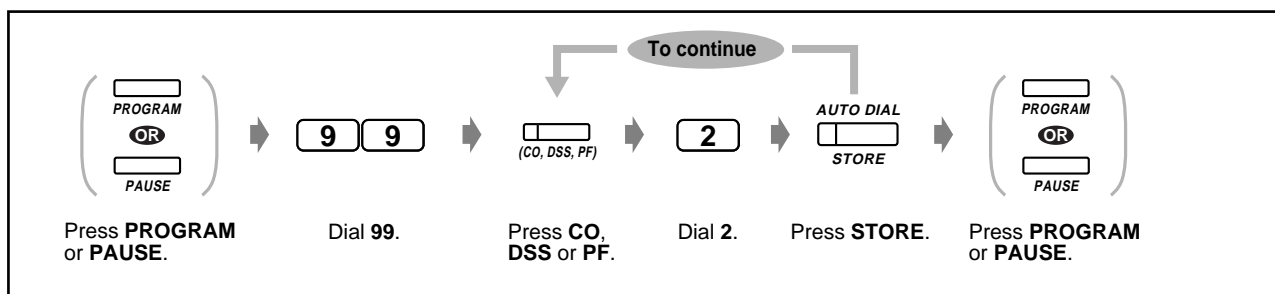

Charge Fee Management

[Pre-assigned extension only]

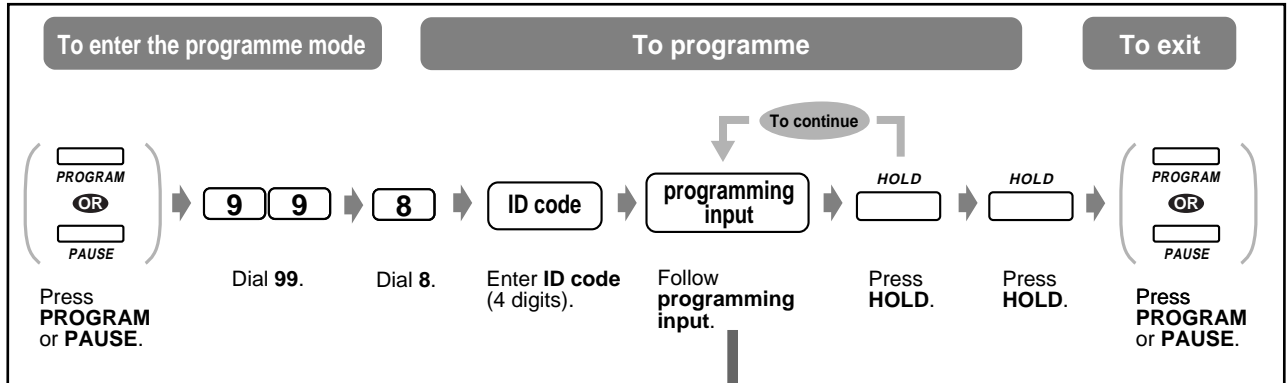

Item	Programming Input
Viewing, clearing or printing each extension charge, outside charge or account code charge.	<p> 1 Extension no. → Viewing → SEL → HOLD OR 2 Outside line no. (01-54) → Clearing → SEL → CLR → HOLD OR 3 Account table no. (001-128) → Print out → SEL → AUTO DIAL → HOLD STORE </p>
Viewing, clearing or printing total extension charge, total outside charge or total account code charge.	<p> 4 Extension no. → Viewing → SEL OR 5 Outside line no. → Clearing → SEL → CLR OR 6 Account table no. → Print out → SEL → AUTO DIAL → STORE </p>
Assigning an account code.	<p> 7 Account table no. (001-128) → CLR → New account no. (10 digit) → AUTO DIAL → STORE </p>

Customising



• You cannot print out the account code charge of the account table number (01) by SMDR.

Customising Your System (System Programming)

Programming Information

You can customise your system according to your application. You can control telephone conditions for each extension, extension group, Class of Service, etc.. For example, you can restrict some extensions from calling external parties. Furthermore, the programmed data, such as system speed dialling, can be used by all extensions.

Your system already has default settings (factory installed). Most of the programming is done by your dealer. Consult your dealer about system applications and re-programming according to your needs.

Only frequently changed programming items (User Programming) are shown in this manual. If you would like to change the following features, extensions which meet certain conditions can re-program them at any time.

The available programming is shown below. (Programme number)

- The date and time (000)
- System speed dialling numbers and names (001/002)
- Extension number and name (003/004)

Required Telephone

A Panasonic Proprietary Telephone with display (e.g. KX-T7433, KX-T7436)

User Password

To enter the programming mode, a user password (4-7digits) is required. It should be programmed through system programming beforehand. Check your password (Default:1234).

Conditions

Only one extension, which is on-hook and holding no calls, is available at one time. If another extension is programming, "Another Use" is displayed.

List

Before programming, decide your selections and write them down in the list for each programming item. These are useful for easy programming and future reference. Your dealer also has programming tables which contain all of the assignments. You may ask for photo copies of these tables to be aware of the features /conditions available.

Overlay / Button Function

The overlay is a paper sheet which is included with the telephone.

In the programming mode, the button functions are different. The overlay shows the functions in the programming mode. Place the overlay on the telephone properly.

If your telephone display shows the necessary functions, the overlay may be not required.

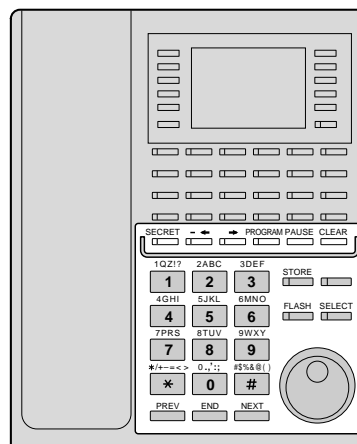

KX-T7436 with the overlay



Display

The display gives you useful messages about programming. The multiple-line display also shows the available functions. Follow the message at each step. This is a display sample in the initial programming mode.

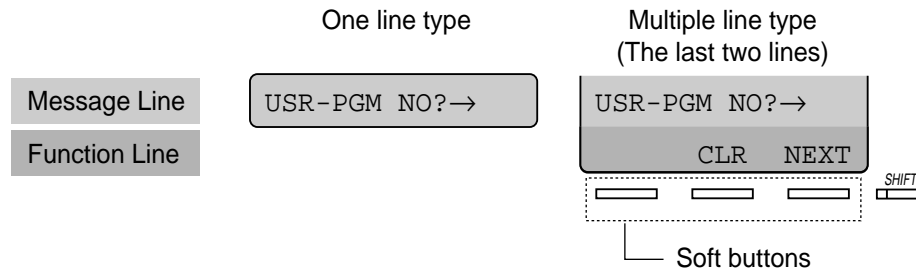

The message line guides you through programming and lets you confirm your selection. For example, when “Jack No? →” is displayed, enter the jack number. The display shows up to 16 characters at a time. To scroll the display, press → or ←. The function line shows you the function of the Soft button located below it. When the SHIFT button light beside the display is on, subtitles are available. Press the SHIFT button to confirm the available functions.

Jack Number / Extension Number

Certain programming is assigned to each jack number. The jack number is where your telephone connects to the system. If two telephones share one jack and have their own extension number (eXtra Device Port [XDP]), the jack number is determined as Jack XX-1 for a proprietary telephone and Jack XX-2 for a single line telephone. The display may show XX-2, even if an extension has not set XDP. **If you do not know the jack number or extension number**, check it as shown below.

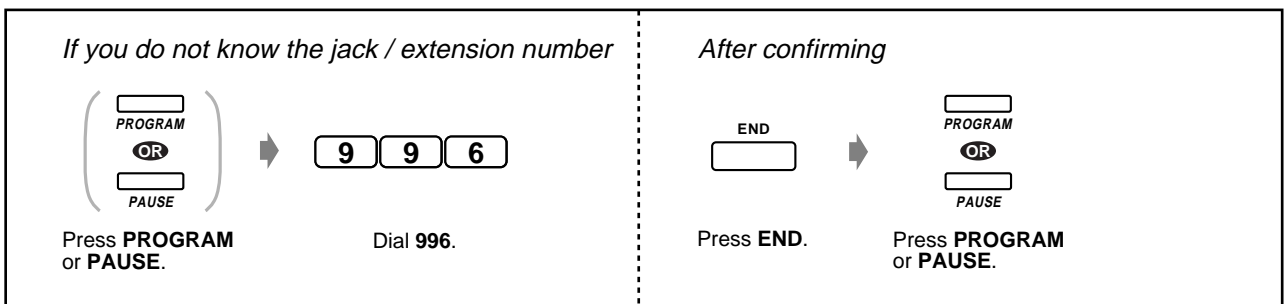

Confirmation

- To confirm your entry after storing data;
- The STORE button light: Lights red.
 - Confirmation Tone:
 - One beep: Your entry is accepted.
 - Three beeps: Your entry is rejected.

Customising Your System (System Programming)

◆◆ Icon Descriptions

Icons are given to guide you through programming. The following is an example of how the icons may be used:

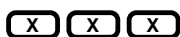

Enter the programme number. (xxx= the specified number)



Press the corresponding button on the telephone or the Soft button which corresponds to the display.

<Example>

 : "NEXT" is displayed.

In this case, both of the following methods are available:

- Press the NEXT () button.
- Press the Soft button which corresponds to "NEXT" shown on the display.



The display messages "SEL+, SEL- and SEL" mean "SELECT".
"CLR" means "CLEAR".



Press the button until the desired entry appears.



Enter your selection.

<Example>

 : "Jack no." is displayed.
Enter the jack number.



◆◆ Procedure

The basic steps are shown below.

1. Entering the programming mode



2. Programming

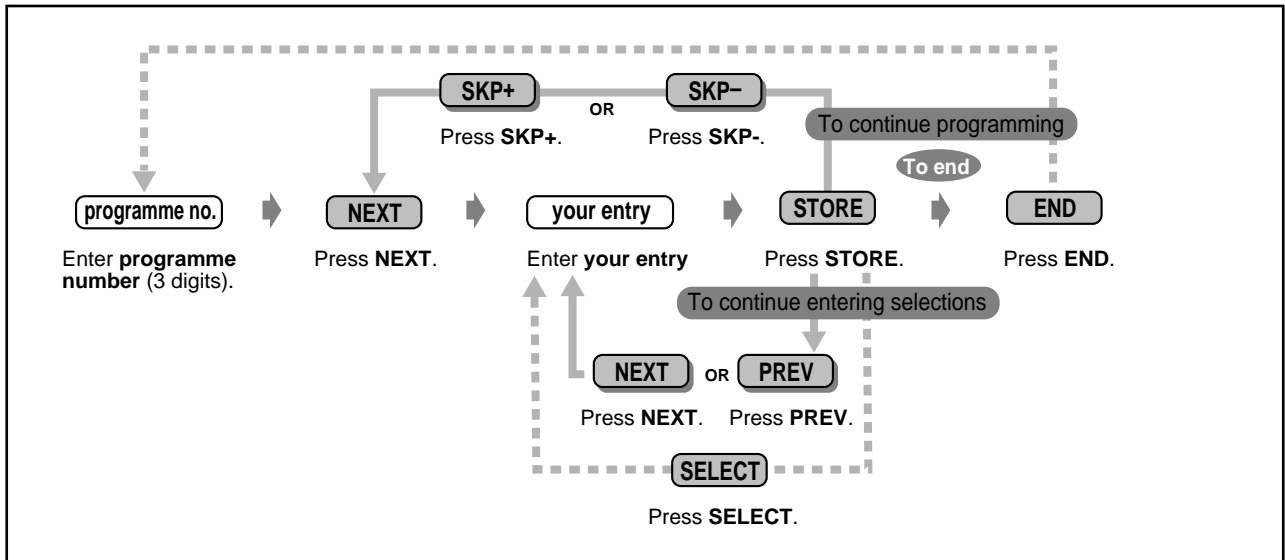

- To delete or change an entry, press CLEAR (TRANSFER).
- To confirm your entry after storing data:
 - The STORE button light: Lights red.
 - Confirmation Tone: One beep: Your entry is accepted.
Three beeps: Your entry is rejected.
- To exit the programming mode at any time, lift the handset.

3. Exiting the mode

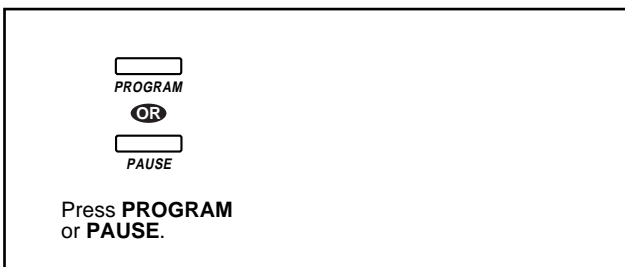

Customising Your System (System Programming)

◆◆ Character Entry

When storing a name or message, enter the characters as follows. The tables below and on the next page show you the characters available for each key. You can enter letters by pressing the alphanumeric keys on your telephone. Example: Key 2 can enter A, a, B, b, C or c.

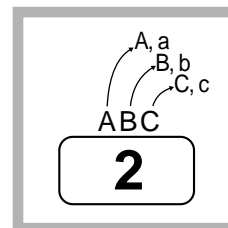

Entering characters

- Press the desired character key.
- Press the matching Soft button, press the SELECT* (AUTO ANSWER) button or rotate the Jog Dial as needed.
- Repeat the appropriate steps for the remaining characters.



- **To erase the last letter**, press the ← (CONF) button.
- **To erase all letters**, press the CLEAR (TRANSFER) button.
- **To alternate between capital and lower case letters**, press the SHIFT button. Once this button is pressed, the mode remains until the SHIFT button is pressed again.

* If your telephone is a KX-T7431, do not use the provided SELECT button. Use the AUTO ANSWER button which becomes the SELECT button when using the overlay.

Combination Table 1





Jog Dial keys	Display sequence by rotating the Jog Dial
1	1 Q q R r S s T t ...
2	2 A a B b C c D d ...
3	3 D d E e F f G g ...
4	4 G g H h I i J j ...
5	5 J j K k L l M m ...
6	6 M m N n O o P p ...
7	7 P p Q q R r S s ...
8	8 T t U u V v W w ...
9	9 W w X x Y y Z z ...
0	0 (space) ! ? . , ' : ; ...
*	* / + - = < > # \$...
#	# \$ % & @ () A a ...



Combination Table 2

Soft button		S1	SHIFT+S1	S2	SHIFT+S2	S3	SHIFT+S3	SHIFT+SHIFT+S1	SHIFT+SHIFT+S2
SELECT button pressing times	0	1	2	3	4	5	6	7	8
keys									
1	1	Q	q	Z	z	!	?		
2	2	A	a	B	b	C	c		
3	3	D	d	E	e	F	f		
4	4	G	g	H	h	I	i		
5	5	J	j	K	k	L	l		
6	6	M	m	N	n	O	o		
7	7	P	p	Q	q	R	r	S	s
8	8	T	t	U	u	V	v		
9	9	W	w	X	x	Y	y	Z	z
0	0	(space)	.	,	'	:	;		
*	*	/	+	-	=	<	>		
#	#	\$	%	&	@	()		

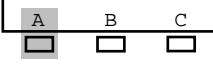
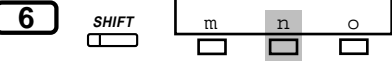
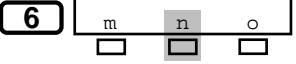
<Example> To enter “Ann”,

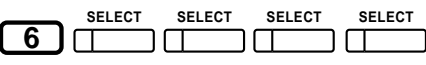
A	n	n
– Using the Jog Dial 2  until “A” is displayed.	6  until “n” is displayed.	6  until “n” is displayed.
– Using a soft button. 2 	6 	6 
– Using the SELECT button. 2 	6 	6 

Customising Your System (System Programming)

Date and Time Set (000)

After setting the current date and time, the proprietary telephone displays the current date and time while on-hook.

Default : 1 Jan '94 SAT 12:00 AM

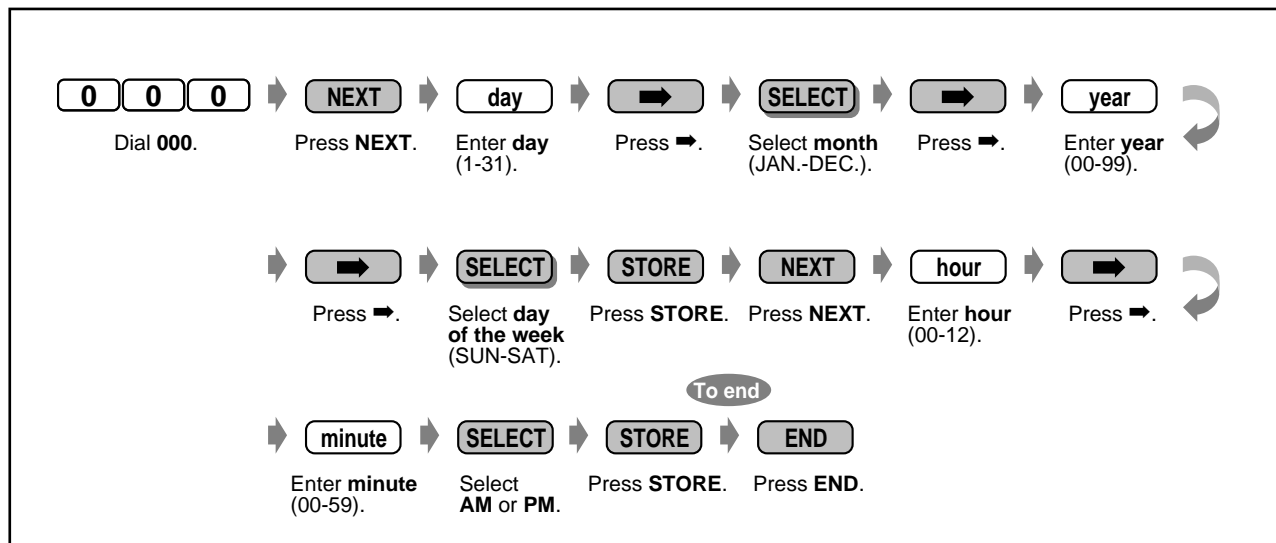

- **After changing the desired entries**, you can press the STORE button. You do not have to perform the rest of the steps.
- The clock starts immediately after the STORE button is pressed.
- You cannot leave an entry empty.



System Speed Dialling Number Set (001)

You can store the phone numbers of up to 500 frequently dialled numbers.

Default : No entry

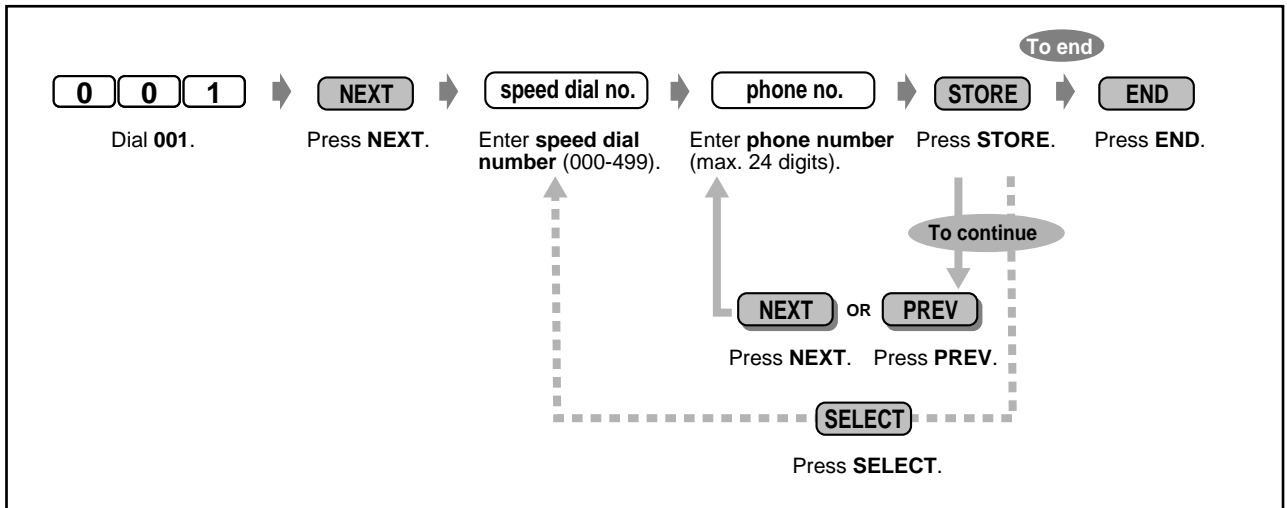

- The programming list is on page 4-17. The directory is on page 6-10.
- If the desired number is more than 24 digits, divide the number and store it into two or more speed dial numbers.
- “*”, “#”, FLASH/RCL, PAUSE, SECRET (INTERCOM) and — (CONF) can also be stored.
 - If you do not want to display the stored number, press the SECRET (INTERCOM) button before and after the numbers you wish to conceal.
 - If you store an external party’s number, you should first store a line access number (9, 81 to 88).
 - If you need to enter an account code, you can enter the specified account code before the line access number.

<Example>

49	1234	#	9	SECRET 1 201 123 4567
Account code feature no.	Account code	Account code delimiter	Automatic Line access number	Phone number

Customising Your System (System Programming)

System Speed Dialling Name Set (002)

You can store the corresponding name of the speed dialling number. These names are displayed when making call with the display operation. (See "How to Use the Display"(Operation))
To enter characters, see page 4-12.

Default : No entry

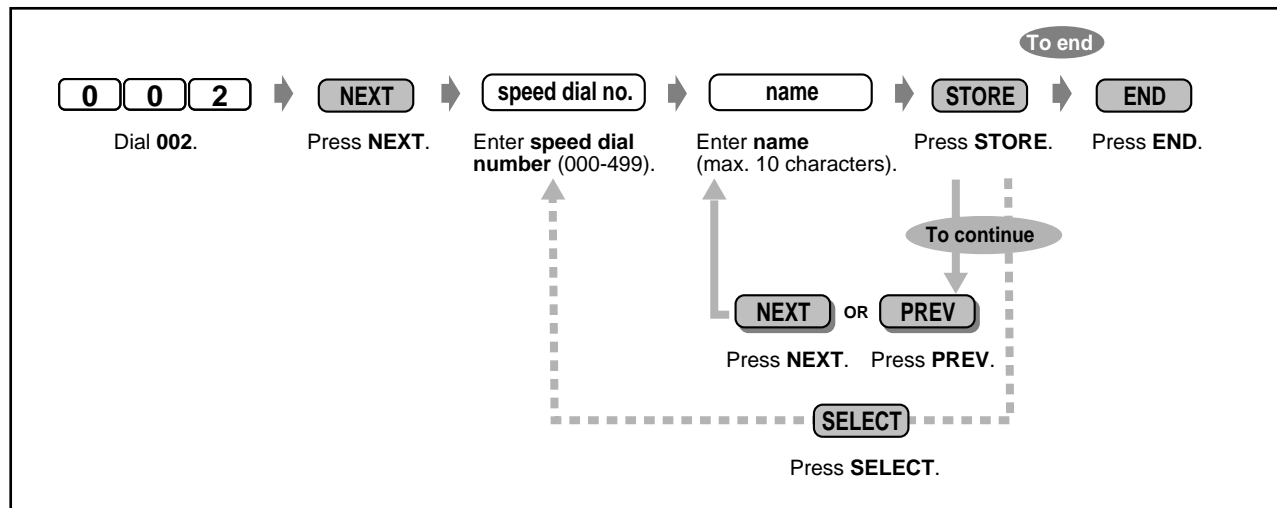

• The programming list is on page 4-17. The directory is on page 6-10.



Programming List for 001/002

Speed dial no.	Name	Phone no.	Speed dial no.	Name	Phone no.
000			043		
001			044		
002			045		
003			046		
004			047		
005			048		
006			049		
007			050		
008			051		
009			052		
010			053		
011			054		
012			055		
013			056		
014			057		
015			058		
016			059		
017			060		
018			061		
019			062		
020			063		
021			064		
022			065		
023			066		
024			067		
025			068		
026			069		
027			070		
028			071		
029			072		
030			073		
031			074		
032			075		
033			076		
034			077		
035			078		
036			079		
037			080		
038			081		
039			082		
040			083		
041			084		
042			085		

Customising Your System (System Programming)

Speed dial no.	Name	Phone no.	Speed dial no.	Name	Phone no.
086			129		
087			130		
088			131		
089			132		
090			133		
091			134		
092			135		
093			136		
094			137		
095			138		
096			139		
097			140		
098			141		
099			142		
100			143		
101			144		
102			145		
103			146		
104			147		
105			148		
106			149		
107			150		
108			151		
109			152		
110			153		
111			154		
112			155		
113			156		
114			157		
115			158		
116			159		
117			160		
118			161		
119			162		
120			163		
121			164		
122			165		
123			166		
124			167		
125			168		
126			169		
127			170		
128			171		



Speed dial no.	Name	Phone no.	Speed dial no.	Name	Phone no.
172			215		
173			216		
174			217		
175			218		
176			219		
177			220		
178			221		
179			222		
180			223		
181			224		
182			225		
183			226		
184			227		
185			228		
186			229		
187			230		
188			231		
189			232		
190			233		
191			234		
192			235		
193			236		
194			237		
195			238		
196			239		
197			240		
198			241		
199			242		
200			243		
201			244		
202			245		
203			246		
204			247		
205			248		
206			249		
207			250		
208			251		
209			252		
210			253		
211			254		
212			255		
213			256		
214			257		

Customising Your System (System Programming)

Speed dial no.	Name	Phone no.	Speed dial no.	Name	Phone no.
258			301		
259			302		
260			303		
261			304		
262			305		
263			306		
264			307		
265			308		
266			309		
267			310		
268			311		
269			312		
270			313		
271			314		
272			315		
273			316		
274			317		
275			318		
276			319		
277			320		
278			321		
279			322		
280			323		
281			324		
282			325		
283			326		
284			327		
285			328		
286			329		
287			330		
288			331		
289			332		
290			333		
291			334		
292			335		
293			336		
294			337		
295			338		
296			339		
297			340		
298			341		
299			342		
300			343		



Speed dial no.	Name	Phone no.	Speed dial no.	Name	Phone no.
344			387		
345			388		
346			389		
347			390		
348			391		
349			392		
350			393		
351			394		
352			395		
353			396		
354			397		
355			398		
356			399		
357			400		
358			401		
359			402		
360			403		
361			404		
362			405		
363			406		
364			407		
365			408		
366			409		
367			410		
368			411		
369			412		
370			413		
371			414		
372			415		
373			416		
374			417		
375			418		
376			419		
377			420		
378			421		
379			422		
380			423		
381			424		
382			425		
383			426		
384			427		
385			428		
386			429		

Customising Your System (System Programming)

Speed dial no.	Name	Phone no.	Speed dial no.	Name	Phone no.
430			465		
431			466		
432			467		
433			468		
434			469		
435			470		
436			471		
437			472		
438			473		
439			474		
440			475		
441			476		
442			477		
443			478		
444			479		
445			480		
446			481		
447			482		
448			483		
449			484		
450			485		
451			486		
452			487		
453			488		
454			489		
455			490		
456			491		
457			492		
458			493		
459			494		
460			495		
461			496		
462			497		
463			498		
464			499		



Extension Number Set (003)

You can assign an extension number to each jack.

Default : Jack no. = Extension no.

KX-TD816 – 01-1 through 16-1= 201 through 216

01-2 through 16-2= 301 through 316

KX-TD1232 – 01-1 through 64-1= 201 through 264

01-2 through 64-2= 301 through 364

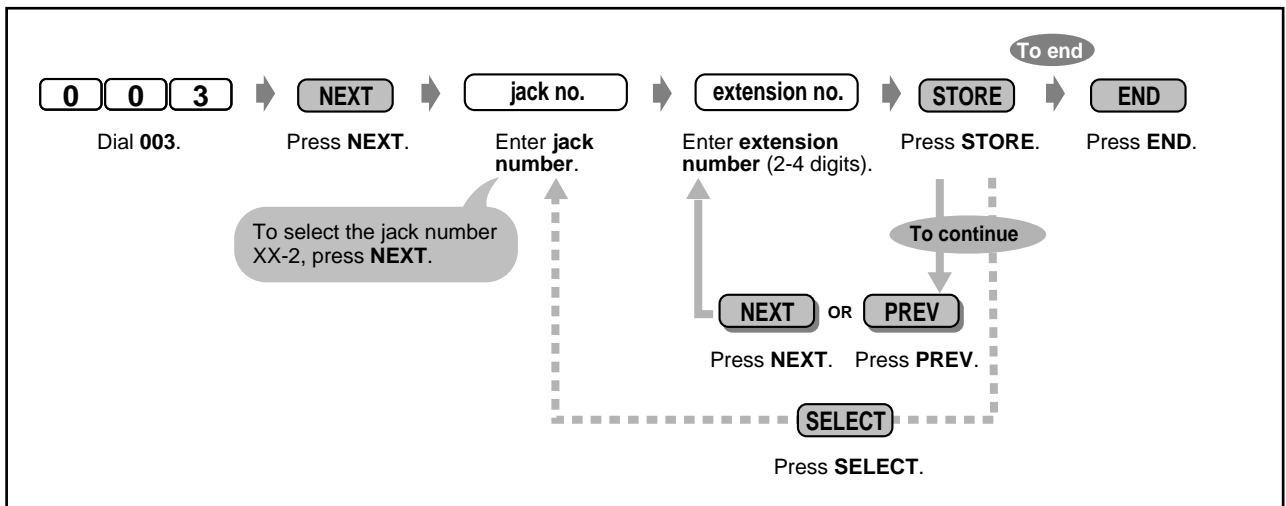

- The leading number(s) should be the same as the assigned number(s) for Flexible Numbering. Consult your dealer.
- A double entry is invalid.

Customising Your System (System Programming)

Extension Name Set (004)

You can store the name of an extension user. This is useful if you want to know who is calling, or who you are calling when making an intercom call using the directory.
To enter characters, see page 4-12.

Default : No entry

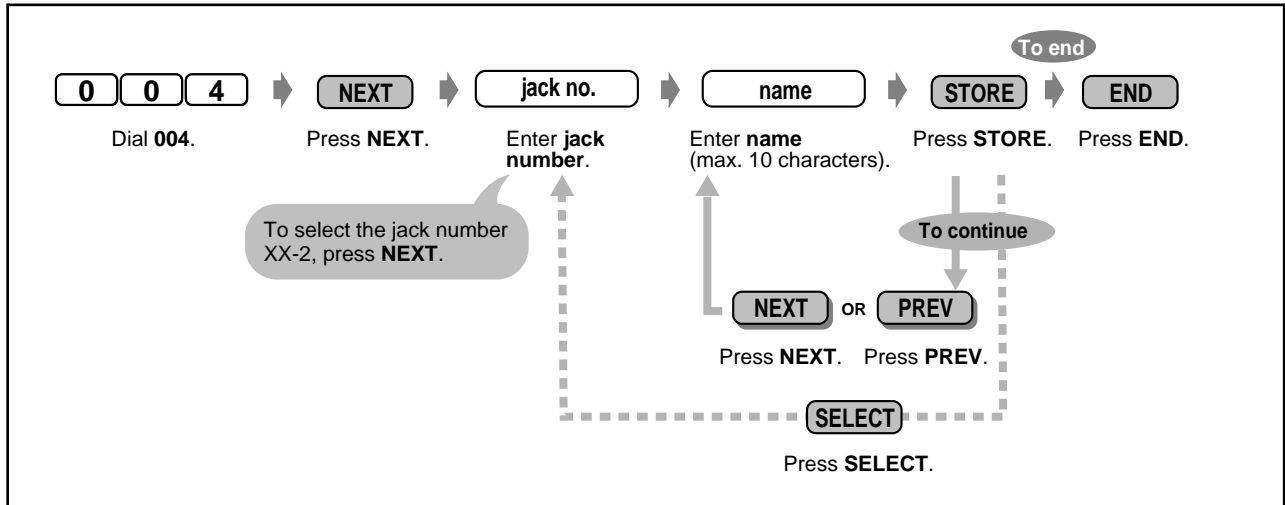



Programming List for 003/004

Jack no.	Extension no.	Name	Jack no.	Extension no.	Name
01-1			01-2		
02-1			02-2		
03-1			03-2		
04-1			04-2		
05-1			05-2		
06-1			06-2		
07-1			07-2		
08-1			08-2		
09-1			09-2		
10-1			10-2		
11-1			11-2		
12-1			12-2		
13-1			13-2		
14-1			14-2		
15-1			15-2		
16-1			16-2		
17-1			17-2		
18-1			18-2		
19-1			19-2		
20-1			20-2		
21-1			21-2		
22-1			22-2		
23-1			23-2		
24-1			24-2		
25-1			25-2		
26-1			26-2		
27-1			27-2		
28-1			28-2		
29-1			29-2		
30-1			30-2		
31-1			31-2		
32-1			32-2		

Customising Your System (System Programming)

Jack no.	Extension no.	Name	Jack no.	Extension no.	Name
33-1			33-2		
34-1			34-2		
35-1			35-2		
36-1			36-2		
37-1			37-2		
38-1			38-2		
39-1			39-2		
40-1			40-2		
41-1			41-2		
42-1			42-2		
43-1			43-2		
44-1			44-2		
45-1			45-2		
46-1			46-2		
47-1			47-2		
48-1			48-2		
49-1			49-2		
50-1			50-2		
51-1			51-2		
52-1			52-2		
53-1			53-2		
54-1			54-2		
55-1			55-2		
56-1			56-2		
57-1			57-2		
58-1			58-2		
59-1			59-2		
60-1			60-2		
61-1			61-2		
62-1			62-2		
63-1			63-2		
64-1			64-2		



• The directory is on page 6-8.

5

DECT Portable Station

This chapter shows you how to operate each DECT Portable Station feature step by step. Read this chapter to become familiar with the many useful features of this DECT system.

Safety Instructions

Take special care to follow the safety suggestions listed below to use the Panasonic DECT Portable Station.

◆◆ Safety

- 1) Power Source: The charger should be connected to a power supply only of the type described in the operating instructions or as marked on the charger.
- 2) Non-use Periods: When the portable station (PS) is not being used, turn the power off. When left unused for a long period of time, the charger should be unplugged from the household AC outlet.

◆◆ Installation

Environment

- 1) Water and Moisture: Do not use this PS and the charger near water – for example, near a bath tub, washbowl, sink, etc. Damp basements should also be avoided.
- 2) Heat: The PS and the charger should be kept away from heat sources such as radiators, kitchen ranges, etc. They also should not be placed in rooms where the temperature is less than 5°C (41°F) or greater than 40°C (104°F).

Placement

- 1) Stacking: Do not place heavy objects on top of the PS and charger.
- 2) Foreign Material: Care should be taken so that objects do not fall onto and liquids are not spilled into the PS and charger. Do not subject the PS and charger to excessive smoke, dust, mechanical vibration, or shock.
- 3) Surface: Place the charger on a flat surface.

◆◆ Battery

To reduce the risk of fire or injury to persons, read and follow these instructions.

- 1) Use only the battery specified.
- 2) Do not dispose of the battery in a fire. It may explode. Check with local waste management codes for special disposal instructions.
- 3) Do not open or mutilate the battery. Released electrolyte is corrosive and may cause burns or injury to the eyes or skin. The electrolyte may be toxic if swallowed.
- 4) Exercise care in handling the battery in order not to short the battery with conductive materials such as rings, bracelets, and keys. The battery and/or conductor may overheat and cause burns.
- 5) Do not recharge batteries, which are provided or specified as replacement parts for use with other products. The battery may leak corrosive electrolyte or explode.
- 6) Do not attempt to rejuvenate the battery provided with or identified for use with this product by heating. Sudden release of battery electrolyte may occur causing burns or irritation to eyes or skin.
- 7) Remove the battery from this product if the product will not be used for a long period of time (several months or more). During this time the battery could leak in the product.
- 8) Discard the “dead” battery as soon as possible. A “dead” battery may leak in the product.
- 9) Do not store this product, or the battery provided with or identified for use with this product, in high temperature areas. Batteries that are stored in a freezer or refrigerator for the purpose of extending shelf life should be protected from condensation during storage and defrosting. Batteries should be stabilised at room temperature prior to use after cold storage.

◆◆ **For Best Performance**

Operating Range

- 1) The range of operation depends on the topography of your office, weather or usage conditions, because signals are transmitted between the Cell Station (CS) and the portable station (PS) by radio waves.
- 2) Normally, you will get greater range outdoors than indoors. If there are obstacles such as walls, noise may interfere with your telephone calls. In particular, high metal shelves or reinforced concrete walls will shorten your operating range.
- 3) A PS may not work if used in places that are too far from the CS depending on the structure of the building.

Noise

Occasional noise or interference may occur due to other sources of electromagnetic radiation, such as refrigerators, microwave ovens, faxes, TVs, radios, or personal computers.

If noise affects your telephone calls, keep the PS away from other electrical appliances.

WARNING:

TO PREVENT FIRE OR SHOCK HAZARD, DO NOT EXPOSE THIS PRODUCT TO RAIN OR ANY TYPE OF MOISTURE.

Before Operating the DECT Portable Station

◆◆ What is the DECT Portable Station?

You can use a Panasonic DECT Portable Station (PS), KX-TD7500, by connecting an optional wireless system to your PBX. It can be used in the system with other telephones.

Capacity

You can use the following number of PS in each system.

KX-TD816 16

KX-TD1232 64

Up to four calls can be made at the same time in the range.

◆◆ Registration

You must register your PS in the system and determine its extension number. For PS registration, consult your dealer.

◆◆ Feature Numbers

To operate certain features, you need to enter specified feature numbers (and an additional parameter, if required).

There are two types of feature numbers as follows:

- Flexible feature number
- Fixed feature number

Fixed feature numbers cannot be changed. However, you can change the flexible numbers to other numbers for easier use. If you want to change the numbers, consult your dealer. In this manual, the default numbers (factory installed) are used for operations.

A flexible number is shown as **0** (half-shaded key). Use the new programmed number if you have changed the feature number. Write the new number in the "Feature Number List" (Appendix).

◆◆ Tones

You will hear various tones, during or after an operation, for confirmation. Refer to "What is This Tone?" (Appendix).

◆◆ Display

The display helps you confirm the settings. For example, when you set the Super EXtra Device Ports (SXDP) feature, the display shows "SXDP On".

Furthermore, your PS can show the guidance messages which show the selectable buttons and help you operate your PS without the operating instructions. Refer to "Customising Your PS – PS Programming".



◆◆ **Your Extension Number / DECT System Number**

You can check your own extension number or/and the connected DECT System number on the display if set to be shown by PS Programming. Refer to “Customising Your PS – PS Programming – Standby Display Selection”.

◆◆ **Examples**

The displays and the illustrations shown as examples are from a PS connected to the KX-TD1232.

◆◆ **Restrictions**

Some features may be restricted at your PS under system programming. Consult your manager or dealer.

Before Operating the DECT Portable Station

◆◆ Icon Descriptions

The following icons show you the feature availability, notes and action to operate the features. While operating the PS, you can easily refer to the Icons noted on the inside back cover of this manual.



Related Programming Title
See "Programming", if necessary.

desired no.

Enter the required number.

<Example>

account code

Enter the account code.



Press the corresponding function
button on the PS.

extension no.

Dial an extension number.



Talk.

phone no.

Dial the telephone number.



You will hear a confirmation, dial, ring
or ringback tone.

C. Tone: confirmation tone

D. Tone: dial tone











R. Tone: ring tone

R. B. Tone: ringback tone







◆◆ Button Descriptions

Your PS has the useful function buttons listed below. These buttons make operations simple.

	Intercom Button: Used to make or receive intercom calls.		Flexible CO Buttons (F1 through F3): Used to seize an outside line or access one of several features.
	Talk Button: Used to make, receive or end calls.		Clear / Transfer Button: Used to clear incorrect digits while entering numbers or transfer a call to another extension.
	Cancel Button: Used to end calls, or exit the directory or Function mode.		Book Button: Used to enter into the directory mode or select a menu in the Function mode.
	Hold Button: Used to place a call on hold.		Flash Button: Used to disconnect a current call and make another call.
	Function Button: Used to enter into the Function mode or access features by pressing additional keys.		Redial Button: Used to redial the last number dialled.
	Auto / OK Button: Used for System Speed Dialling and storing program changes.		

Combination Buttons*

Some special features can be used by combining two buttons.

	Pause Button (⏸): Used to insert a pause in numbers.		Conference Button (⏶): Used to establish a three party conversation.
	Message Button (✉): Used to leave a message waiting indication or call back the party who left the message waiting indication.		Tone Button: Used to change the dialling mode temporarily to tone.
	FWD/DND Button (⏪): Used to set the Call Forwarding or Do Not Disturb (DND) features.		



* These buttons can also be activated using the display. Refer to "Operation – Selecting the Feature Buttons on the Display".

Before Operating the DECT Portable Station

◆◆ How to Follow the Steps

A sample operation is shown below.

Feature title

 **Calling without a Restriction**

◆◆ Using an account code (Account Code Entry)

An Account Code gives information about outside calls for accounting and billing purposes. You may not be able to make an outside call without an account code entry. The mode is assigned to each user. Ask your manager for your mode.

Sub feature title

Description

PT / SLT

Operation steps
The description of the icons are explained on page 2-4 and the inside back cover of this manual.

Conditions

- **A Panasonic proprietary telephone user** can enter an account code during a conversation and when hearing a reorder tone after the other party hangs up.
- **If you enter the wrong code**, press the “*” key while entering the account code and then re-enter the code.
- **To cancel the entry**, press the Account button while entering the code.
- **For your convenience**, you can store the code with the phone number in memory (e.g. Speed dialling).
- **If you hear a reorder tone**, the entered account code is wrong. Enter the correct code.

Hints

!! You may give a specified account code to extension users and check their telephone usage. You can specify an account code to each client and check the call duration.

Customising Your Phone

- **Customising the Buttons**
Create or re-arrange an Account button.

Programming References: The related or required programming is noted. To programme, see “Customising Your Phone & System”.

5-8 DECT Portable Station



Making Calls

◆◆ Calling another extension

◆ To another extension (Intercom Call)

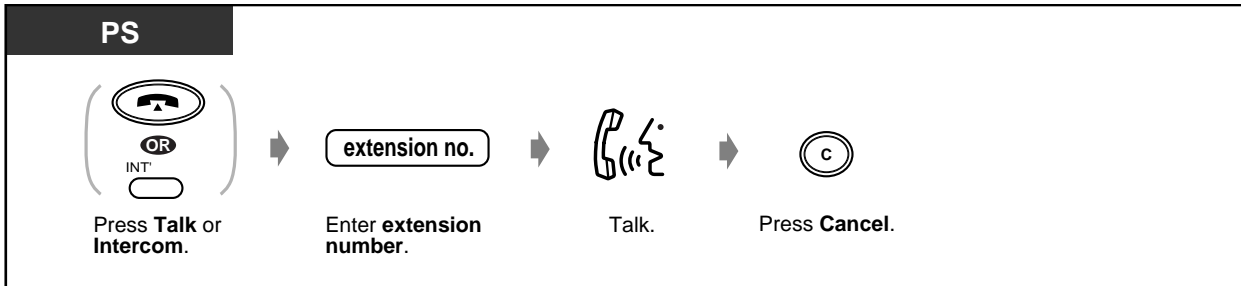

<Example>

When you call Mr. Thomas....

Mr. Thomas's extension number is 123.

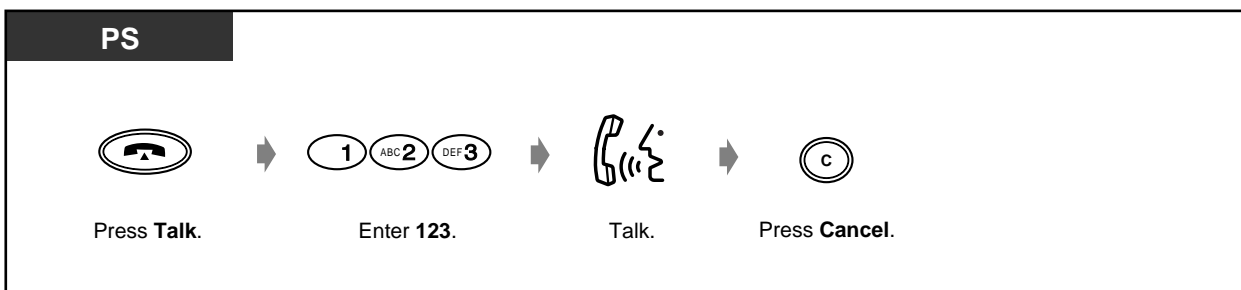

- You can also finish the conversation by placing the PS on the charger or pressing Talk button.
- If “Y” flashes, move towards the Cell Station and try again.









- **Do you have an extension directory?**
Complete the directory on page 5-8 and make a photo copy for your reference.
- **If you misdial,** press the Flash button and enter the number again.
- **Confirming the dialed number before connecting**
You can go off-hook after confirming the number you dialed. If you misdial, press the Clear button to clear each number from the left.
- **Handover**
Even if you move during a conversation, the linking Cell Station (CS) will automatically switch without disconnecting the call. Handover is available only during a conversation (except a conference call). It is not available when a switched CS is busy or there is no CS in the new range.

Operation

◆◆ Calling an external party

You have to seize an outside line before dialling an outside phone number because external calls are made via your system.

Select one of the following methods:

- Press an idle  button.
- Dial automatic line access number  .
An idle line is selected automatically.
- Dial outside line number   to   .
A specific line is selected.

◆ Using a Flexible CO button

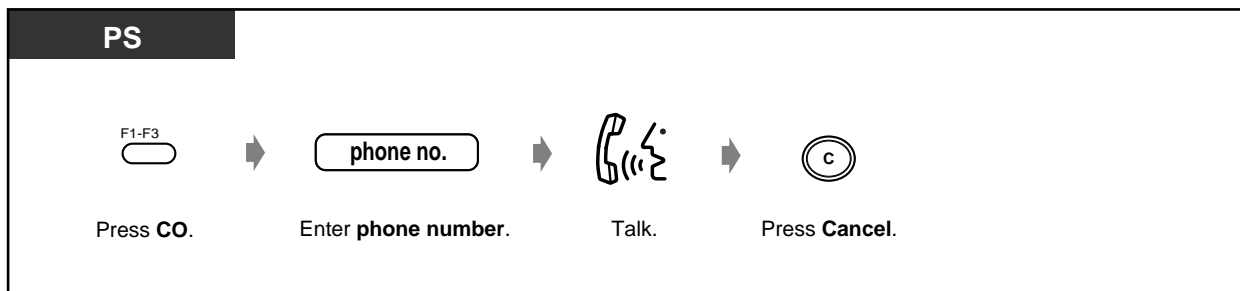

◆ Using automatic line access number / outside line number

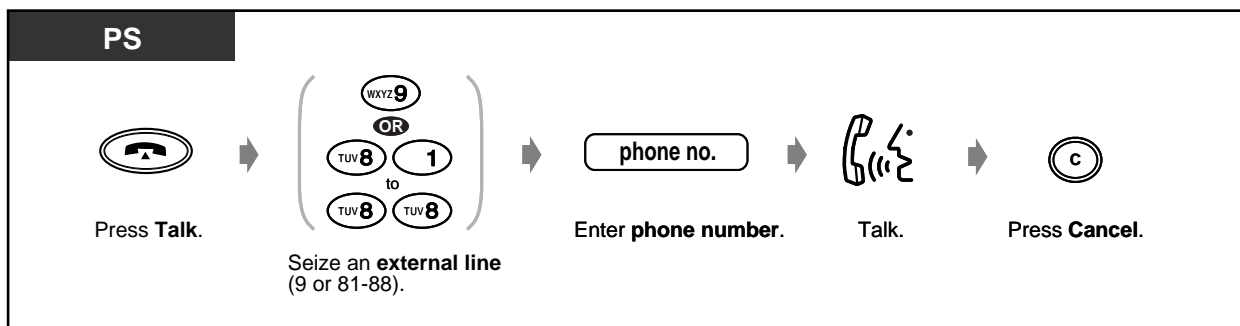

- You can also finish the conversation by placing the PS on the charger or pressing Talk button.
- If “Y” flashes, move towards the Cell Station and try again.
- **Emergency call**
You can dial pre-programmed emergency numbers without any restrictions.
(Default: 999, 112)



- **If you misdial**, press the Flash button and enter the number again.
- **To select the less expensive line automatically**, dial “9” or press the Loop-CO button to seize a line. (**Automatic Route Selection**)
- **Confirming the dialled number before connecting**
You can go off-hook after confirming the number you dialled. If you misdial, press the Clear button to clear each number from the left.
- **Call information**
The following information can be referred to by repeatedly pressing the CO button in use.
 - Phone number (outgoing call) or call duration (incoming call)
 - Meter
 - Call charge



Receiving Calls

When you receive a call, the portable station (PS) rings or vibrates, and the CO line number or extension number of the receiving call will appear on the display.



- You can hang up also by pressing the Talk button or placing the PS on the charger.



Customising Your PS

- **Setting the Quick Answering Mode**
Select to answer calls by just lifting the ringing PS off the charger. (Default: ON)
- **Setting the Automatic Answer Mode**
Select the answering mode when using the headset. (Default: OFF)



- **If the PS is on the charger**, just lift up the PS (Quick Answering).
- **If a headset is connected to the PS**, You can select the answering mode.

Operation

Redial

This is convenient when calling the same external party again.

- Redialling the last number you dialled
- Redialling one of the last five outside phone numbers you dialled

◆◆ Redialling the last number you dialled (Last Number Redial)

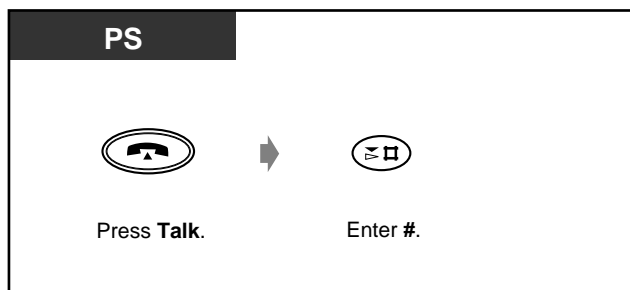

◆◆ Redialling one of the last five outside phone numbers you dialled (Call Log)

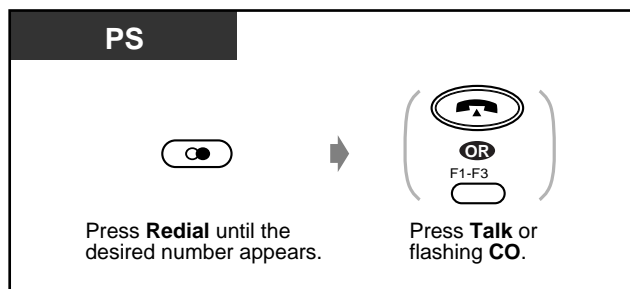

◆ To clear all of the numbers in the call log

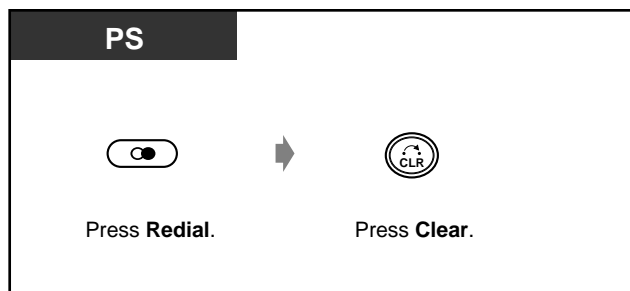

Holding a Call

- Holding
- Denying other people the possibility of retrieving your held calls



- If a call is not retrieved within a specified time, you will hear an alarm as a reminder.
- If a call is not retrieved within fifteen minutes, it is automatically disconnected.

◆◆ **Holding (regular)**

PS



During a conversation



Press **HOLD**.

◆ **To retrieve a call**

PS

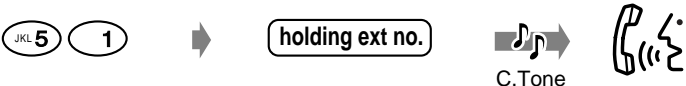
- **At the holding extension**

Press **CO** or **Intercom**. Talk.
- **For an outside call from another extension**

Press **CO**. Talk.
- **For an intercom call from another extension**

Dial **51**. Enter **holding extension number**. C.Tone Talk.

Operation



- The CO or Intercom button light shows the current status as follows:
 - Flashing green:** Your held call
 - Flashing red:** Another extension's held call
- You can hold either an intercom call or an outside call at one time.
- **To hold multiple intercom calls**, use the "Call Park" feature.

◆◆ Denying other people the possibility of retrieving your held calls (*Exclusive Call Hold*)

Only the held extension can retrieve the call.

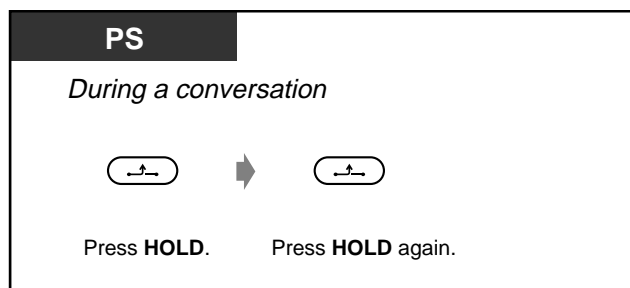

◆ To retrieve a call

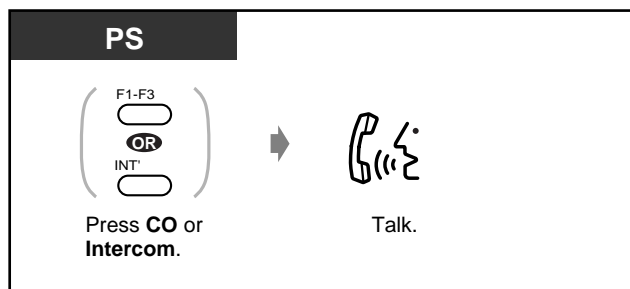



Transferring a Call

– Transferring to an extension

– Transferring to an external party

◆◆ Transferring to an extension

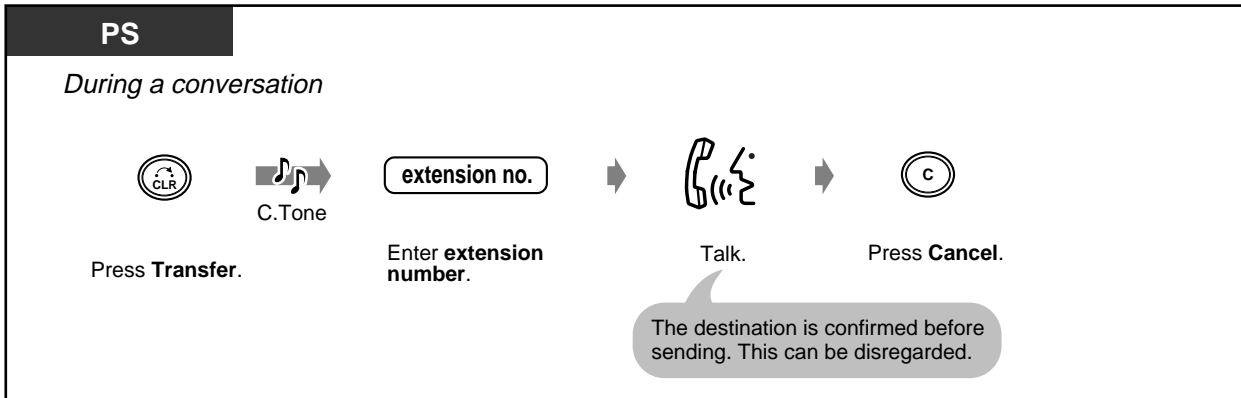

◆◆ Transferring to an external party

Some extensions may be restricted from performing this function.

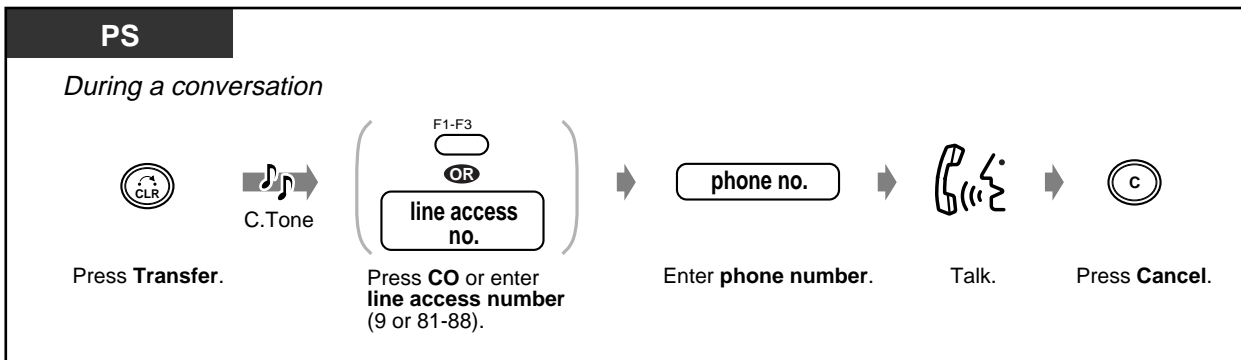

- **If you misdial**, press the Flash button, and re-enter the number.
- **To return to the held call**, press the Transfer button, corresponding CO or the Intercom button before the destination answers.
- **To return to the conversation**, press the corresponding CO button.
- **If you hear an alert tone**, the destination extension did not answer the call. Answer the call.

Operation

Using the Call Directory

- Storing the names and numbers
- Entering characters
- Making calls using the Call Directory

You can store names and/or phone numbers in the directory. A stored number is dialled out by selecting a name or phone number in the directory. There are four types of directory features, including one PS directory and three PBX directories.

PS Dialling Directory: You can store up to 100 private names and phone numbers of outside parties. All directory items are stored in alphabetical order.

PBX System Speed Dialling Directory: You can make a call via the system by selecting system-assigned names and phone numbers (500 max.).

PBX Extension Dialling Directory: You can make a call via the system by selecting system-assigned extension names.

PBX Station Speed Dialling Directory: You can make a call via the system by selecting privately assigned names and phone numbers (10 max.).

Storing the names and numbers

You can store, edit or delete the PS Dialling Directory or PBX Station Speed Dialling Directory items on your PS. There are five displays for directory entry/edition/deletion as shown below.

Display sequence in "MODIFY BOOK" display

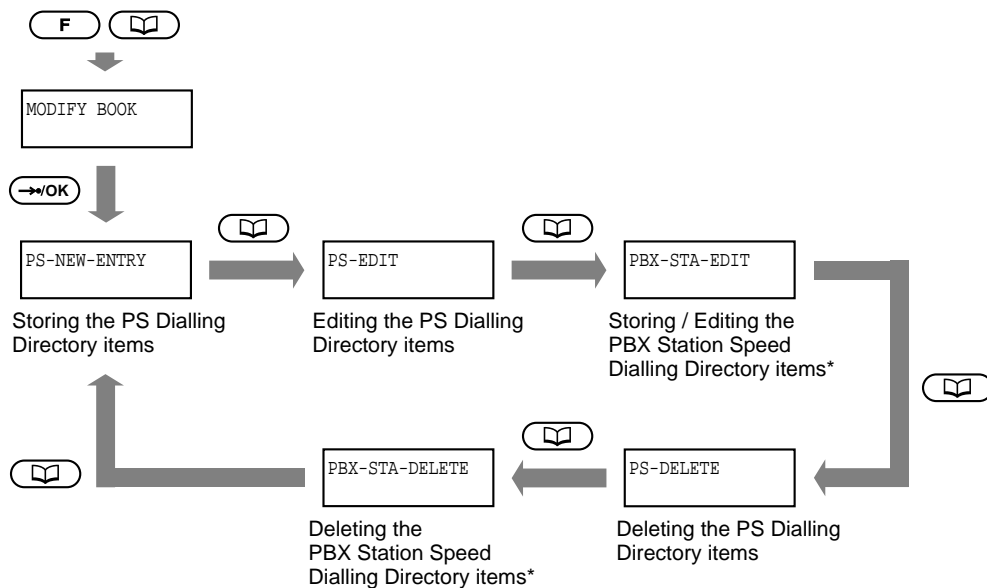

- It is not possible to edit items in the PBX System Speed Dialling or PBX Extension Dialling Directories.
- * Only displayed when registered to a Panasonic Digital Super Hybrid System. It is not displayed when out of range.



◆ To store a PS Dialling Directory item

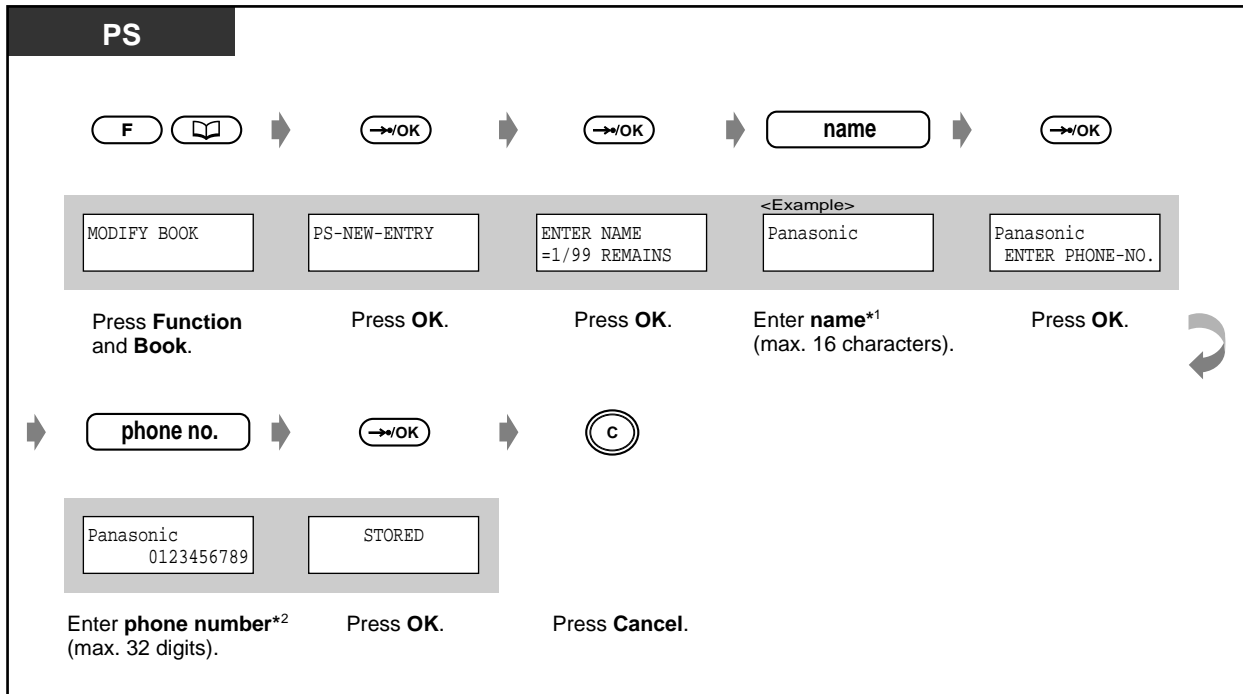

• To store a phone number first and then a name:



- To store a phone number only, skip the step for entering name.
- *1 To enter characters, see page 5-22.
- *2 The line access number is not required.

Operation

◆ To edit a PS Dialling Directory item

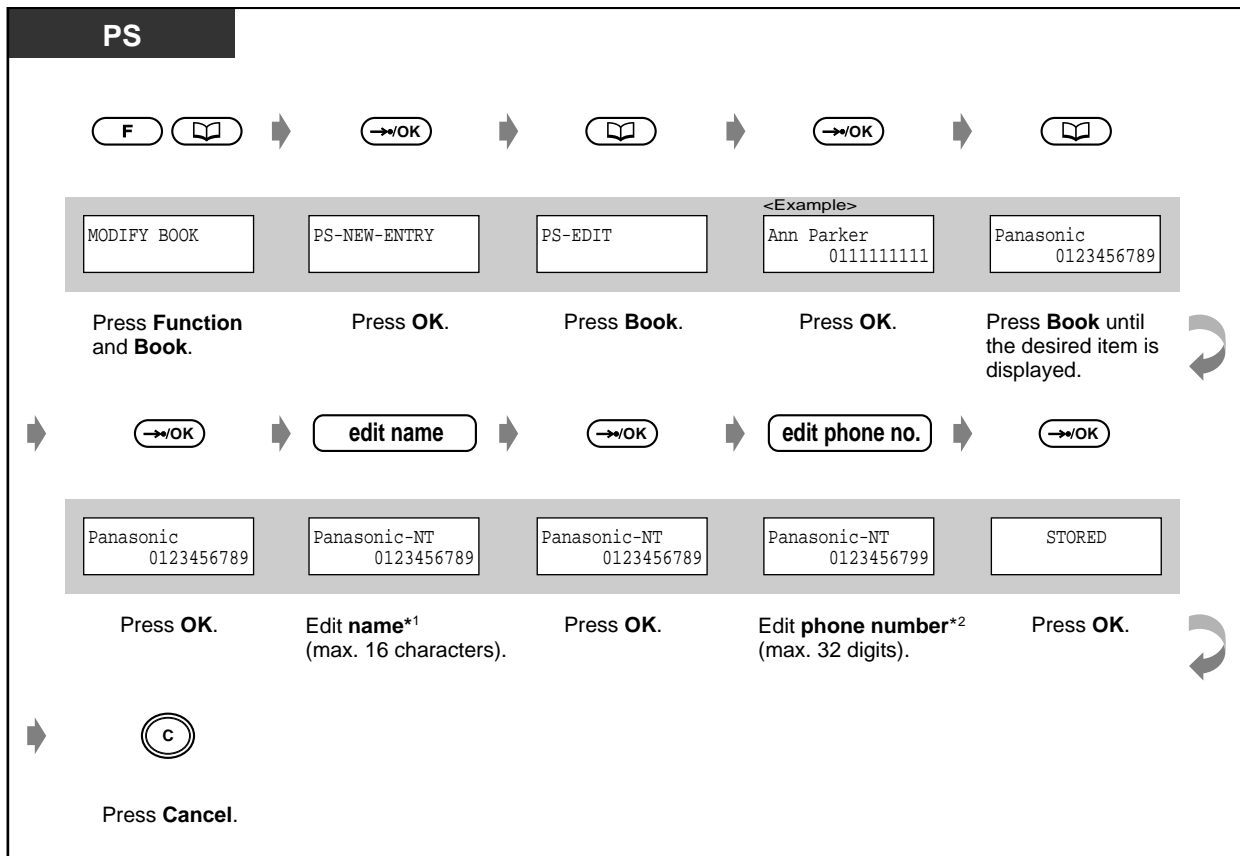

- *1 To enter characters, see page 5-22.
- *2 To change the number, press the Clear button to clear a digit from the left, and enter the number again. To move the cursor on the number, Use # (to the left) or * (to the right) button.



◆ To store / edit a PBX Station Speed Dialling Directory item

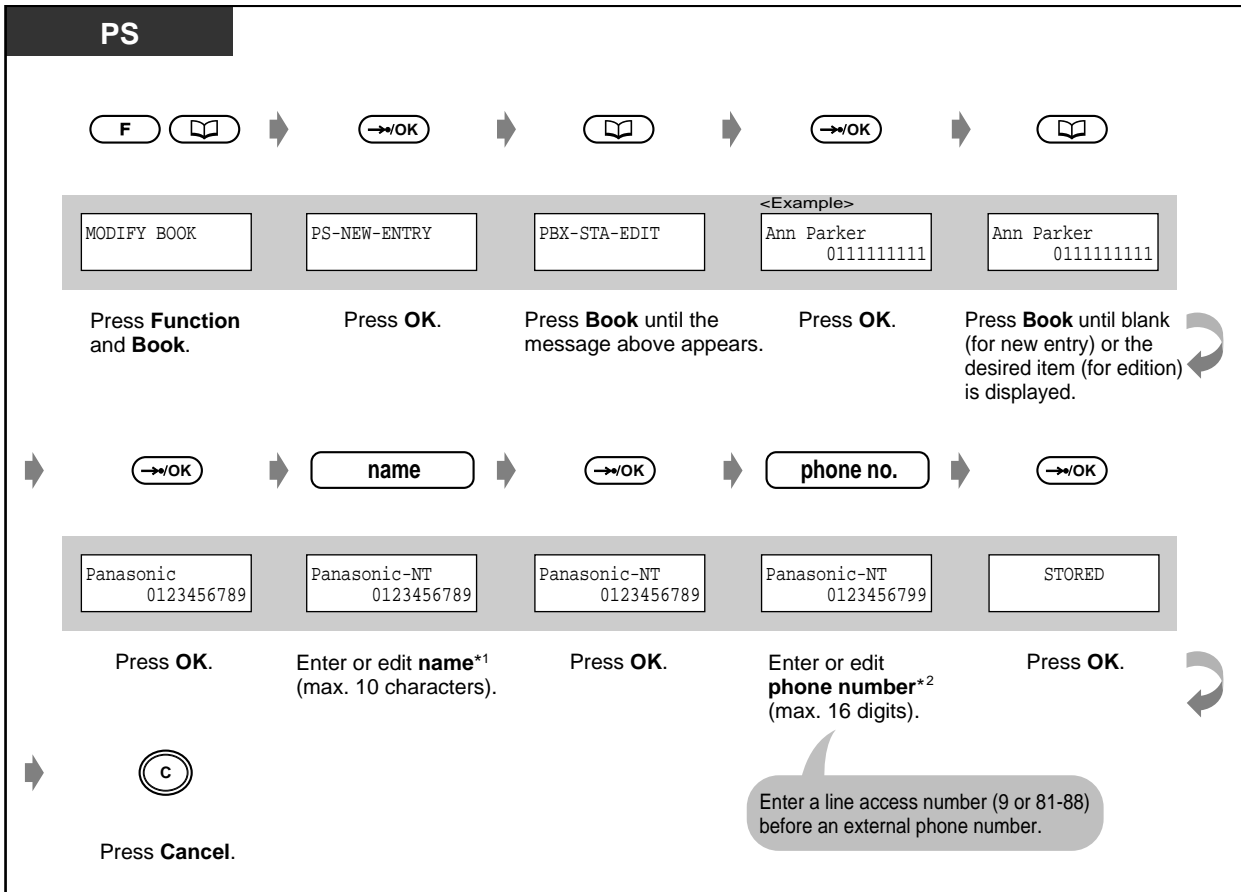

- *1 To enter characters, see page 5-22.
- *2 To change the number, press the Clear button to clear a digit from the left, and enter the number again. To move the cursor on the number, press the # (to the left) or * (to the right) button.

Operation

◆ To delete a PS Dialling / PBX Station Speed Dialling Directory item

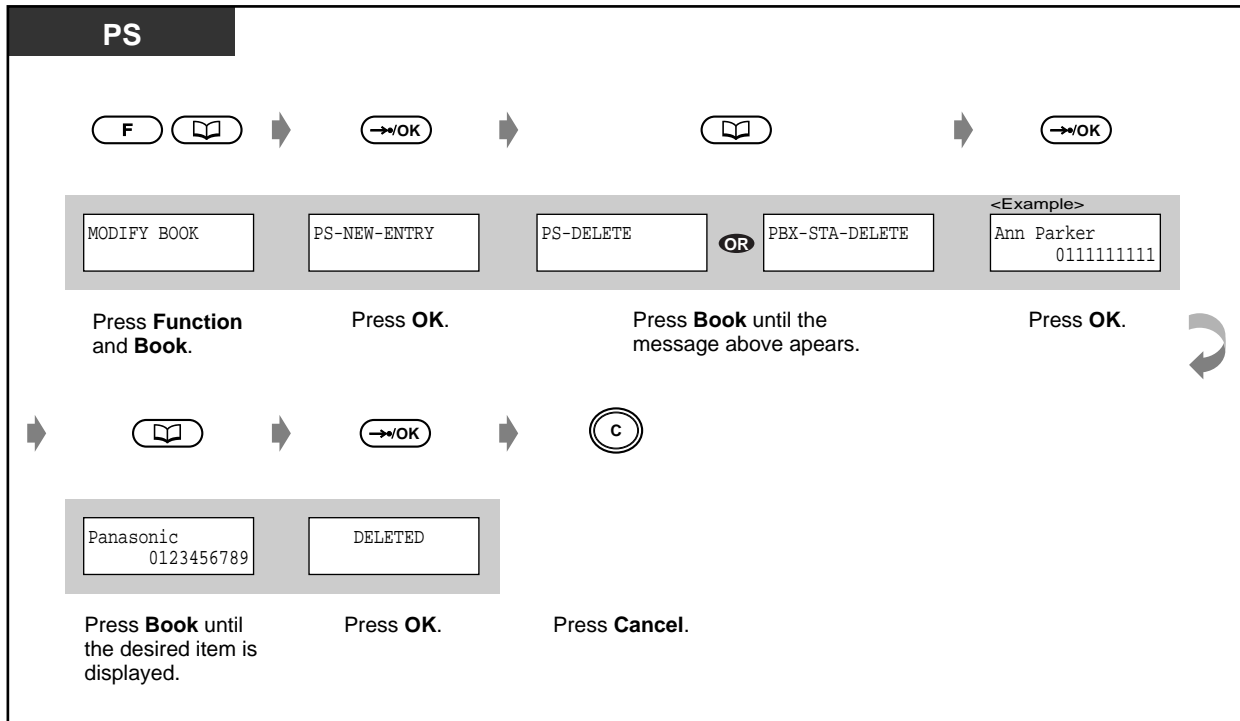



◆◆ Making calls using the Call Directory

There are four displays for directory dialling as shown below.

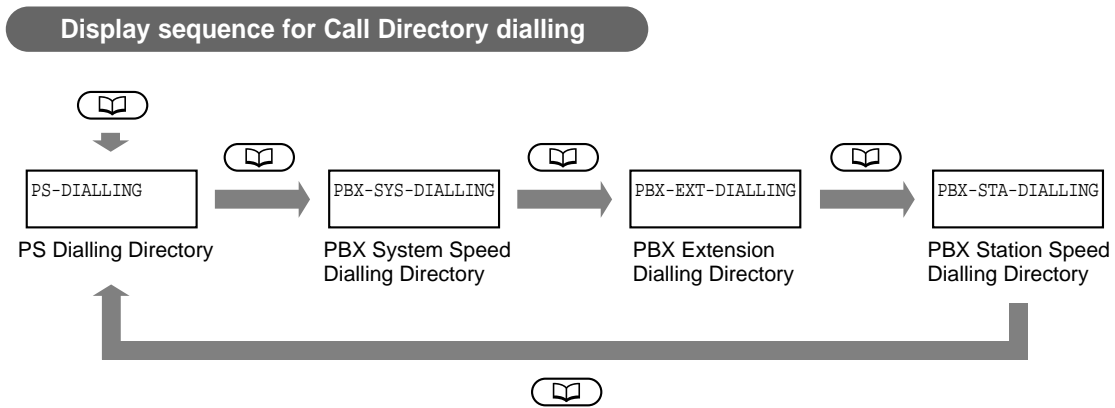

- These displays will not appear when registered to a non-Panasonic Digital Super Hybrid System or when out of range. In this case, the directory item appears after pressing the Book button.
- You can transfer a call to a number stored in the directory. In this case, press the Transfer button during a conversation and then dial by selecting the directory item.

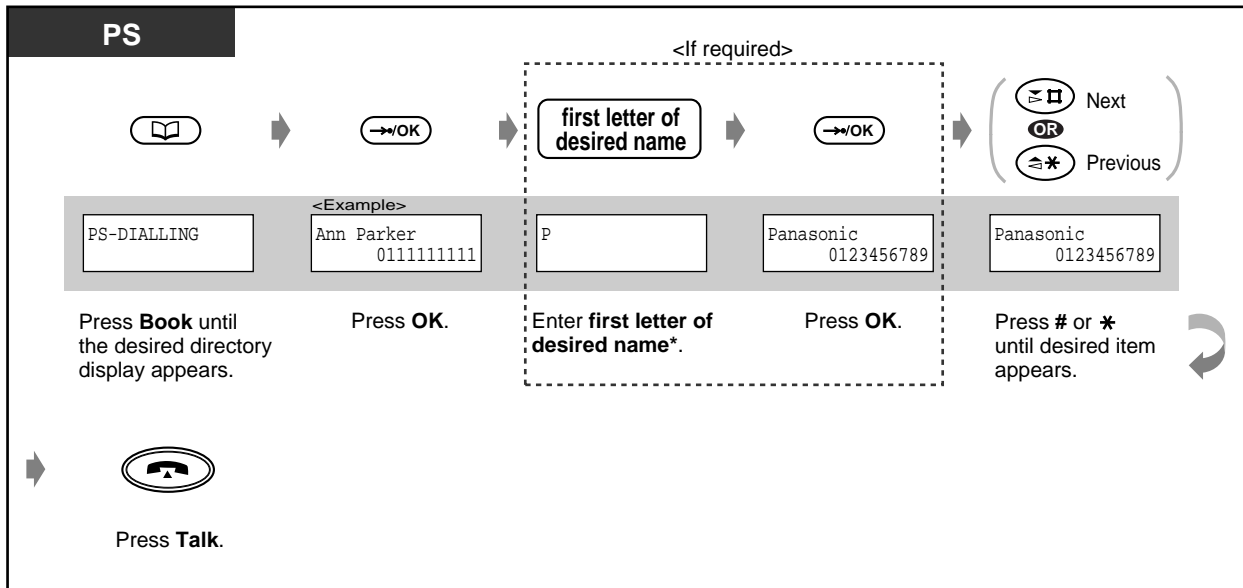

* To enter characters, see page 5-22.

Operation

◆◆ Entering characters

When storing a name or message, enter the characters as follows.
 The table below shows you the characters available for each key.
 You can enter letters by pressing the alphanumeric keys on your telephone.
 Example: Key 2 can enter A, a, B, b, C or c.

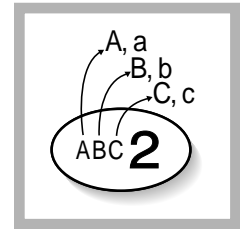

- To erase the each letter from the left, press the Clear button.
- To move the cursor, press the # (to the left) or * (to the right) button.

Combination Table

Keys	Display sequence by pressing the key
1	Ä ä Ö ö Ü ü 1
2	A a B b C c 2
3	D d E e F f 3
4	G g H h I i 4
5	J j K k L l 5
6	M m N n O o 6
7	P p Q q R r S s 7
8	T t U u ü V v 8
9	W w X x Y y Z z 9
0	(space) , : / - () 0
*	Moves the cursor to the left
#	Moves the cursor to the right

<Example> To enter “Ann”,

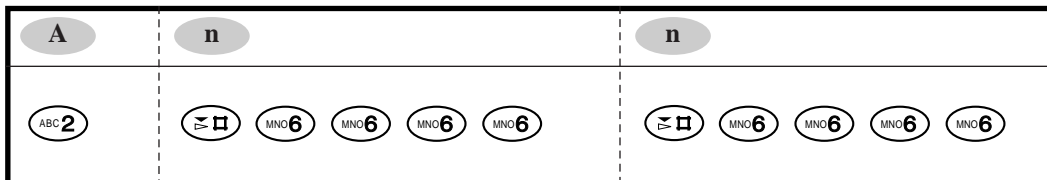



Using Your PS in Parallel with the Wired Telephone (Super EXtra Device Ports [SXDP])

Your PS can be used in parallel with a proprietary wired (PT) or single line telephone (SLT). When in the SXDP mode, incoming calls to a wired telephone also reach the paired PS, while incoming calls to a PS only reach the PS. If one telephone is busy, you cannot make a call from the other telephone.

The “Call Forwarding – All” feature for the wired telephone can also be set from the paired PS so that all incoming calls to the wired telephone will be forwarded to the desired destination.

◆ To set

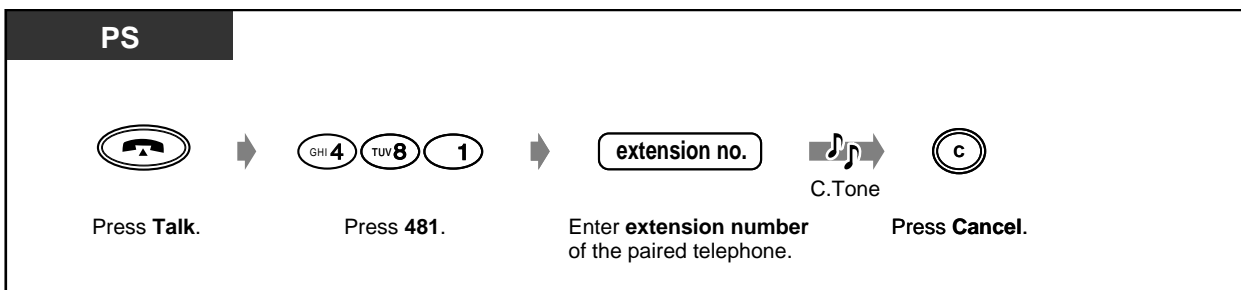

◆ To cancel

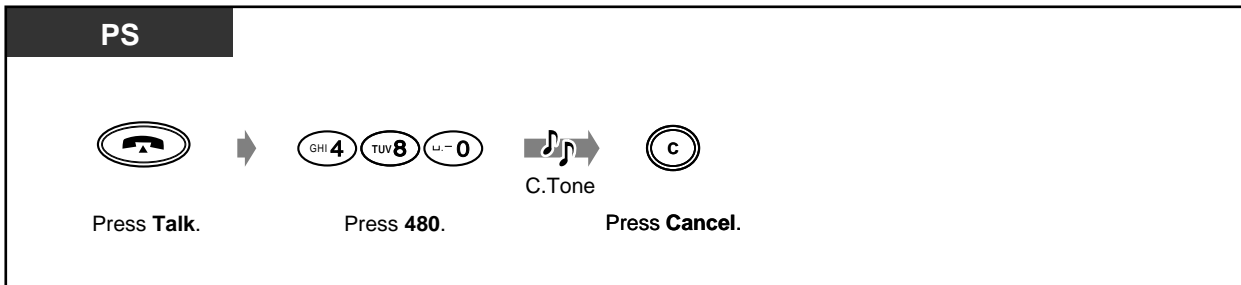

◆ To confirm the extension number of the paired telephone

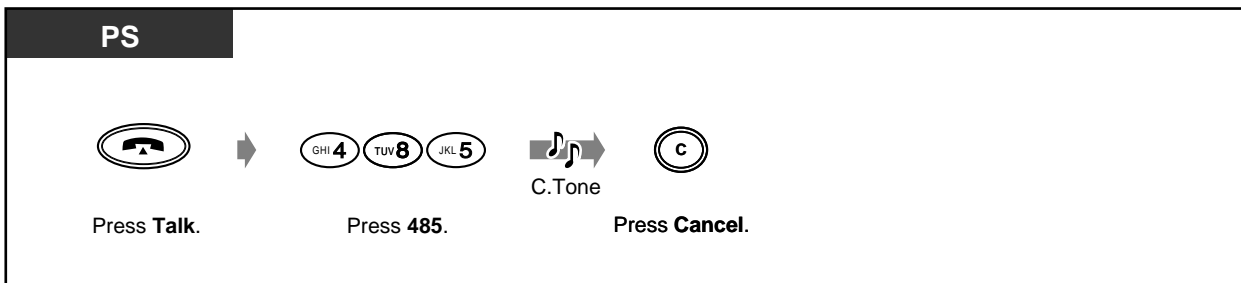

Operation

◆ To set the “Call Forwarding – All Calls” for the paired telephone

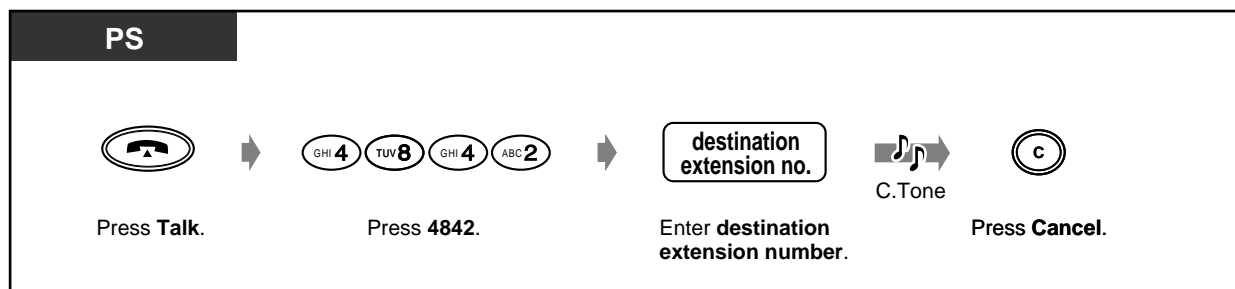

◆ To set the “Call Forwarding – All Calls” for the paired telephone

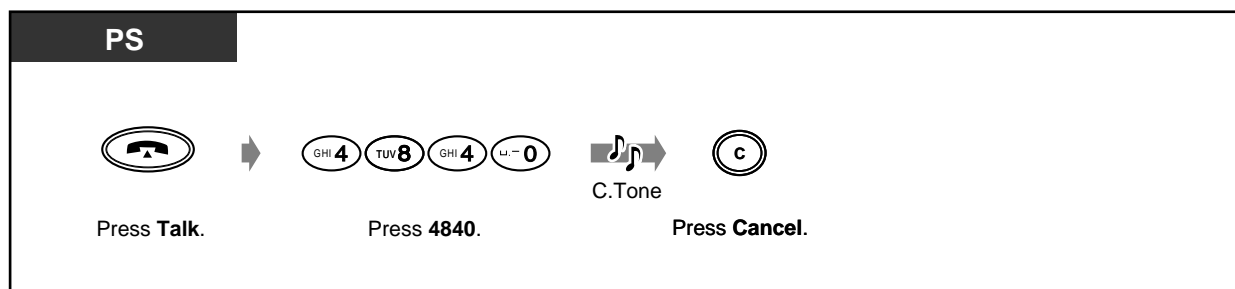

- The Call Log memory can be used by both the PS and paired telephone.
- Some wired telephones are restricted to perform this feature.



Locking the Keypads

Incoming calls can be answered, but outgoing calls cannot be dialled.

◆ **To lock / unlock**

PS

While on-hook



Press **Function** for **2 seconds**.

Operation

Selecting the Feature Button on the Display

The following buttons can be activated using display operations.

- Pause Button
- FWD/DND Button
- Message Button
- Conference Button
- Tone Button

Display sequence in "KEY" display

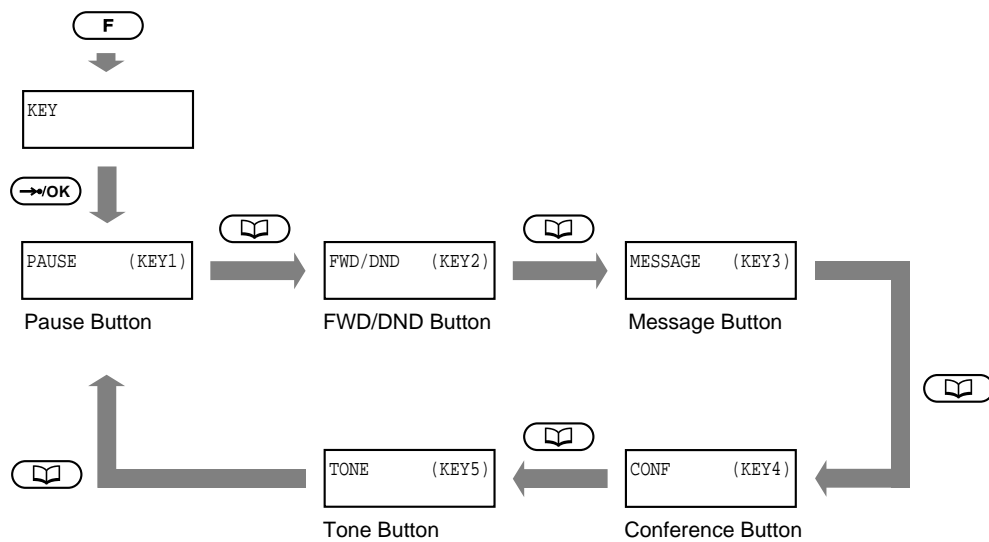

<Example>

To cancel the Do Not Disturb feature

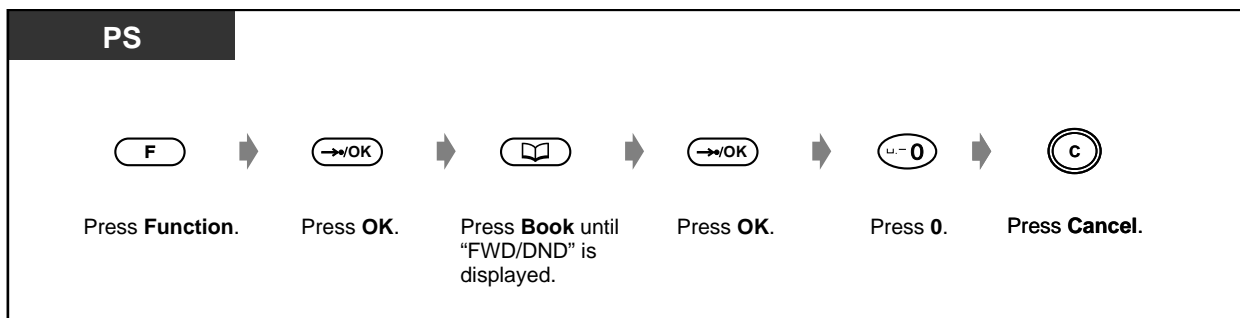

- These buttons can also be activated using a combination of buttons. For descriptions and button combinations, refer to "Before Operating the DECT Portable Station – Button Descriptions"





















Other Operations

Most of the wired telephone features are also supported by a system with a DECT portable station (PS). For feature descriptions and details, refer to the respective features in Operation (Section 2).

Desired Function	Operation
Making Calls	
Basic Calling To an operator	General Call ► WXYZ 9 Specific Call ► [MNC 6 1 Operator 1 / MNC 6 ABC 2 Operator 2]
Basic Calling Cancelling an external party Emergency Call	► F1-F3 ► emergency number
Easy Dialling With one touch button	► F1-F3
Easy Dialling Using numbers stored at your extension	Storing a phone number ► MNC 6 0 ► station speed dial no. (0-9) ► phone no. ► ► Dialling ► MNC 6 ► station speed dial no. (0-9)
Easy Dialling Using numbers stored in the system	► ► system speed dial no. (000-499)
Easy Dialling Using a single digit number	► quick dial number.
Easy Dialling To a pre-set party by going off-hook	Programming the phone number ► PQRS 7 GHI 4 ABC 2 ► phone number ► ► Setting / Canceling ► PQRS 7 GHI 4 ► [1 set / 0 cancel] ► Dialling
Redial Redialling the last number you dialled	►
Redial Saving the number and redialling	Storing <i>During a conversation or while hearing a busy tone</i> ► F1-F3 Dialling ► F1-F3











Operation

Desired Function	Operation
Making Calls	
<p>When the Dialed Line is Busy or There is No Answer Leaving a message waiting indication</p>	<p>To leave a notification  ► PQRS7 ◻-0 1 ► extension no. ► C</p> <p>To leave a notification when the extension is busy  ► GHI 4 ► C  ► F + DEF 3 ► C</p> <p>To cancel a notification  ► PQRS7 ◻-0 ◻-0 ► extension no. ► C</p> <p>To call back  ► PQRS7 ◻-0 ABC 2 ► C  ► F + DEF 3 ► C</p> <p>To clear all notifications  ► PQRS7 ◻-0 ◻-0 ► receiver's extension no. ► C</p>
<p>When the Dialed Line is Busy or There is No Answer Joining an existing call</p>	 ► PQRS7 DEF 3 DEF 3 ► [1 Set / ◻-0 Cancel] ► C
<p>Calling without Restrictions Using an account code</p>	<p>Entering before dialing  ► GHI 4 WXYZ 9 ► account code ► ≅ □</p>
<p>Calling without Restrictions To an extension refusing the call</p>	<p><i>While hearing the DND fine</i>  ► ABC 2</p>
<p>Alternating the Calling Method</p>	<p><i>When hearing the ring back tone, ring-calling</i>  ► ≅ □</p> <p><i>When hearing the confirmation tone, voice-calling</i>  ► ≅ □</p>
Receiving Calls	
<p>Answering Calls</p>	<p>F1-F3 </p>
<p>Answering a Call Ringing at Another Telephone</p>	 ► <div style="border: 1px dashed black; padding: 5px;"> <p>CO Line GHI 4 ≅ *</p> <p>Directed GHI 4 1 ► extension no.</p> <p>Group GHI 4 ◻-0</p> </div> ► C
<p>Answering a call via an External Speaker</p>	<p>Answering the external pager  ► GHI 4 GHI 4 ► extension pager number</p> <p>Answering the external ringer  ► GHI 4 PQRS7 ► extension ringer number</p>
During a Conversation	
<p>Holding a Call To retrieve a call</p>	<p>Retrieving an outside call -from another extension F1-F3 </p> <p>Retrieving an intercom call -from another extension  ► JKL 5 1 ► extension no.</p>

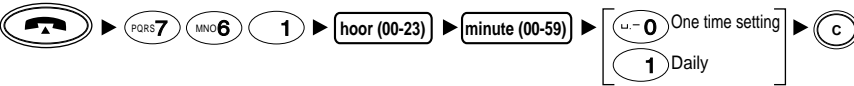

Desired Function	Operation
During a Conversation	
Holding a Call Holding in a system parking zone	To set ► JKL 5 ABC 2 ► parking zone number ► C To retrieving ► JKL 5 ABC 2 ► stored parking zone number
Talking to Two Parties Alternately	During a conversation while holding another call During a conversation with an intercom call while holding another intercom
Transferring a Call Transferring to an extension Transferring to an external party	► [extension no. to an extension F1-F3] ► [phone no. to an external party] ► ► C
Three-party Conversation Adding a third party during a conversation	+ GHI 4 ► third party's no. ► ► + GHI 4
Three-party Conversation Leaving a conference	<i>When you are talking with two external parties</i> + GHI 4
Saving a Number	Storing <i>While hearing a Call Waiting tone</i> ► ► phone number ► Save Dialling ► Save
Before Leaving Your Desk	
Forwarding your Calls	► PQRS 7 1 U-0 ► <div style="border: 1px dashed black; padding: 5px; display: inline-block;"> All calls ABC 2 ► extension no. ► C Busy DEF 3 ► extension no. No answer GHI 4 ► extension no. Busy / No answer JKL 5 ► extension no. To an outside line MNO 6 U-0 ► phone no. ► Follow Me PQRS 7 ► your extension no. </div>
Showing an Absent Message on the Caller's Telephone Display	► PQRS 7 JKL 5 U-0 ► message no. ► C
Preventing Other People from Using Your Telephone	► [PQRS 7 PQRS 7 lock code lock code Lock] ► C [PQRS 7 PQRS 7 lock code] Unlock
Leaving a Call Distribution Group	► <div style="border: 1px dashed black; padding: 5px; display: inline-block;"> GHI 4 JKL 5 U-0 + group no. For Log-In to specific group GHI 4 JKL 5 1 + group no. For Log-Out from specific group GHI 4 JKL 5 U-0 + For Log-In to all groups GHI 4 JKL 5 1 + For Log-Out from all groups </div> ► C

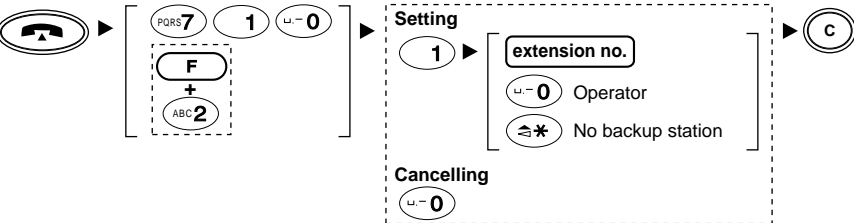
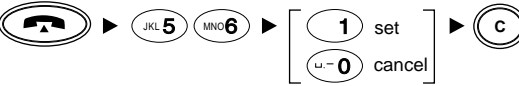
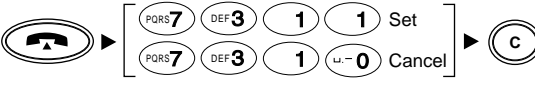

Operation

Desired Function	Operation
Making / Answering an Announcement	
Paging	<p>All</p>  <p>External -To access all external pagers  -To access a particular pager only </p> <p>Group -To access all groups simultaneously  -To access a particular group of extensions </p>
Paging a Person and Transferring a Call	
Answering a Paged Announcement Through the telephones	 <p>To answer a "Paging-External" To answer a "Paging-Group" in the same extension group</p>
Setting the Telephone According to Your Needs	
Setting the Alarm	<p>Setting</p>  <p>Canceling</p>  <p>Checking the setting time</p> 
Refusing Incoming Calls	 <p>Setting 1 → [extension no.] u-0 Operator No backup station</p> <p>Canceling u-0</p>
Refusing Incoming Calls Refusing direct outside calls	<p>Setting / Canceling</p> 
Receiving a Call Waiting	<p>Setting / Canceling</p>  <p>To talk to the new caller, terminate the current call While hearing a Call Waiting tone</p>  <p>To talk to the new caller, hold the current call While hearing a Call Waiting tone</p> 



Desired Function	Operation
Setting the Telephone According to Your Needs	
<p>Preventing Your Number Being Displayed on the Called Party's Telephone</p>	<p>To show / To restrict your number</p> <p> ► ► [Cancel] ►]</p> <p>[Set]</p> <p>To change the setting at any time for a particular call</p> <p> ► ► ► <input type="text" value="phone number"/></p>
<p>Preventing Your Number Being Displayed on the Calling Party's Telephone</p>	<p>To restrict showing your number to the calling party</p> <p> ► ► [Cancel] ►]</p> <p>[Set]</p>
<p>Denying Other People the Possibility of Picking up your Calls</p>	<p> ► ► [set] ►]</p> <p>[cancel]</p>
<p>Denying Other People the Possibility of Joining Your Conversation</p>	<p> ► ► [Set] ►]</p> <p>[Cancel]</p>
<p>Checking the Day / Night Service Status</p>	<p>Switching modes using the feature number</p> <p> ► ► [for Auto mode] ►]</p> <p>[for Manual Day mode]</p> <p>[for Manual Night mode]</p>
<p>Clearing the Feature Settings at Your Extension</p>	<p> ► ►]</p>
Using User-supplied Equipment	
<p>If a Doorphone / Door Opener is Connected To call the doorphone</p>	<p> ► ► <input type="text" value="doorphone number"/></p>
<p>If a Doorphone / Door Opener is Connected Opening the door</p>	<p> ► [► <input type="text" value="doorphone number"/> from a specified extension] ►]</p> <p>[from any extension while to the doorphone]</p>
<p>If a Doorphone / Door Opener is Connected Opening the door</p>	<p> ►]</p>
<p>If a Voice Processing System is Connected Voice mail integration</p>	<p>Setting Call Forwarding destination to Voice Mail (VM)</p> <p> ► ► <input type="text" value="Call Forwarding number. (2-5)"/> ► <input type="text" value="VM extension number"/> ►]</p> <p>Listening to a stored message</p> <p> ► <input type="text" value="VM extension number"/></p>
<p>If a Voice Processing System is Connected To record into another mailbox</p>	<p><input type="text" value="Voice Mail (VM) Transfer"/> ► <input type="text" value="extension number."/></p>
<p>If a Voice Processing System is Connected Recording a conversation</p>	<p>Recording into your mailbox</p> <p><input type="text" value="Two-Way Record"/></p> <p>Stopping recording into your mailbox</p> <p><input type="text" value="Two-Way Record"/></p> <p>Recording into another mailbox</p> <p><input type="text" value="Two-Way Transfer"/> ► <input type="text" value="extension number."/></p> <p>Stopping recording another mailbox</p> <p><input type="text" value="Two-Way Transfer"/></p>

Operation

Desired Function	Operation
Using User-supplied Equipment	
If an External Relay is Connected	 ► MNO 6 ► PORS 7 ► relay number ► C
If an External Ringer is Connected	Answering <i>While hearing a tone from the external ringer</i>  ► GHI 4 ► PORS 7 ► external ringer number
Using the Display Proprietary Telephone	
Changing the display	F1-F3 

Customising Your PS

Programming Information

You can customise your telephone functions with your DECT portable station (PS).

PS Programming: You can change the initial settings according to your needs.

PBX Programming: You can enter into the proprietary wired telephone (PT) programming mode (Station Programming) and program several items for your PS.

There are three displays for programming as shown below.

Display sequence in "PROGRAMMING" display

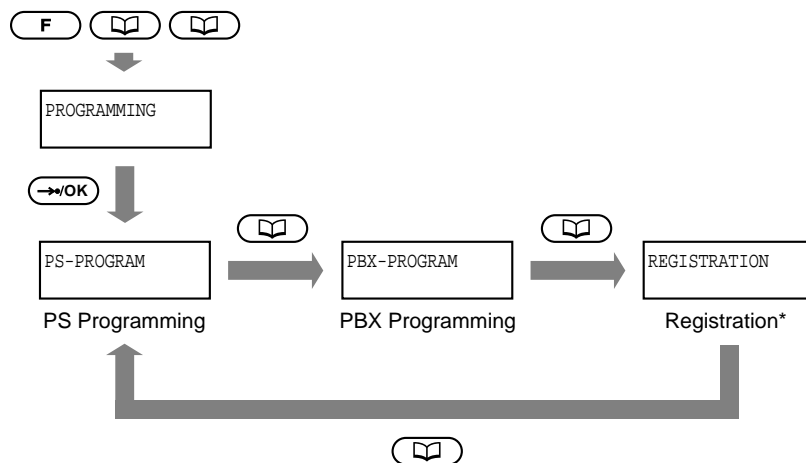

* This display is used for PS registration and not displayed if the DECT System Lock is set. For details, consult your dealer.

Customising Your PS

PS Programming

You may be required to enter a **PS Programming password** or a **DECT System Lock password** when entering the PS Programming mode.

Depending on the password, the number of possible programming items changes for PS security reasons. There are three password levels.

Level 0: A password is not required.

Level 1: A PS Programming password is required.

Level 2: A System Lock password is required.

After selecting the PS programming display, "ENTER PASSWORD" may be displayed.

If not displayed, no password is required.

The combinations of the passwords are as shown below.

If DECT System Lock password is:	DISABLE	DISABLE	ENABLE	ENABLE
If PS Programming password is:	DISABLE	ENABLE	DISABLE	ENABLE
System Lock password	Not required.	Not required.	Level 0 – 2 are possible.	Level 0 – 2 are possible.
PS Programming password	Not required.	Level 0 – 2 are possible.	Not required.	Level 0 – 1 are possible.
No password or If incorrect password	Level 0 – 2 are possible.	Level 0 is possible.	Level 0 – 1 are possible.	Level 0 is possible.



◆◆ To set the PS Programming / DECT System Lock password

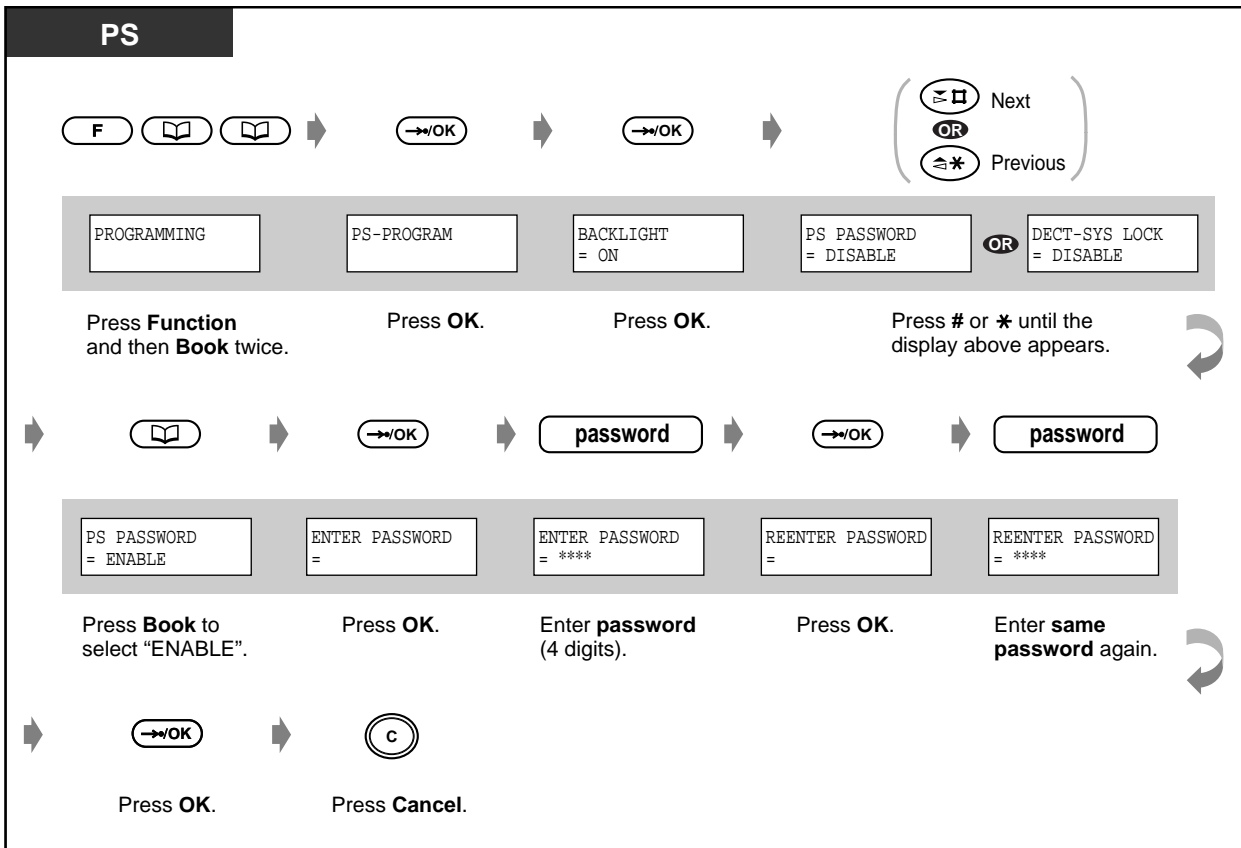

◆◆ To cancel the PS Programming / DECT System Lock password

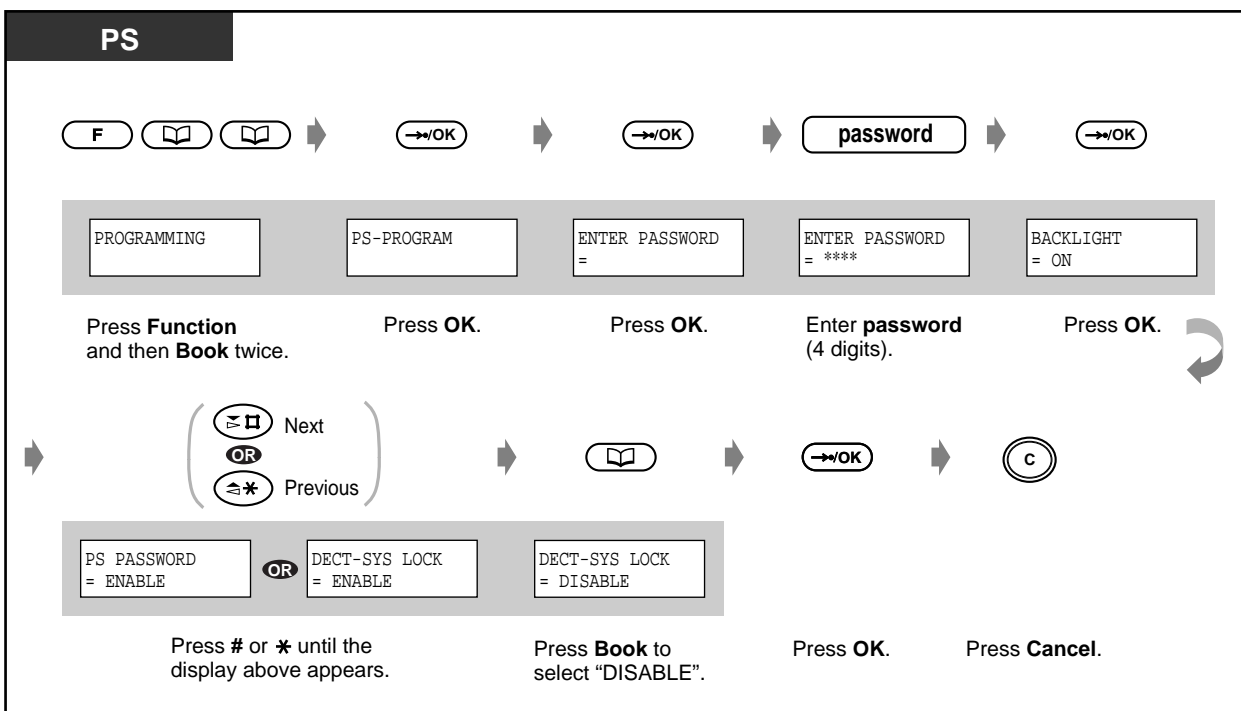

Customising Your PS

◆◆ To change the initial settings or program your PS

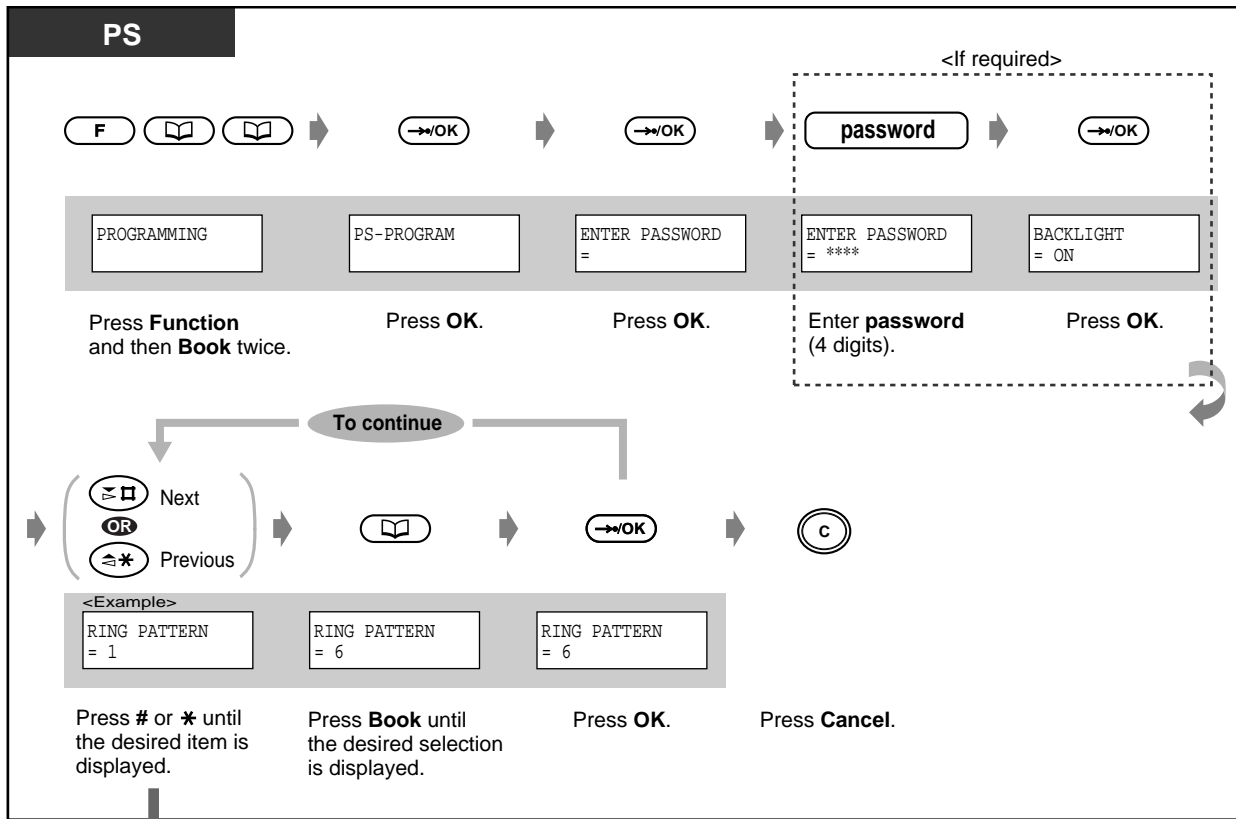

Display	Item	Selection	Level
BACKLIGHT = ON	Do you prefer the keypad backlight? (Keypad Backlight Mode Set)	<input type="checkbox"/> No (OFF) <input checked="" type="checkbox"/> Yes (ON)	0
KEY TONE = ON	Do you prefer to hear the key tone (except during PBX Programming mode)? (Key Tone Set)	<input type="checkbox"/> No (OFF) <input checked="" type="checkbox"/> Yes (ON)	0
RING PATTERN = 1	Which ringer pattern do you prefer in 6 patterns? (Ringer Pattern Selection)	<input type="checkbox"/> Ringer pattern no. <input type="text"/> <input checked="" type="checkbox"/> Ringer pattern 1	0
VIBRATION & RING = OFF	How do you receive a call? (Vibration and Ring Type Selection)	<input type="checkbox"/> Ring and vibrate at the same time (RING & VIB) <input type="checkbox"/> Vibrate for 9 seconds then ring (VIB→RING) <input checked="" type="checkbox"/> Not use the vibration and ring mode (OFF)	0



Display	Item	Selection	Level
LANGUAGE = AUTO	Do you prefer to change the display language? (Display Language Selection)	<input type="checkbox"/> English <input type="checkbox"/> German <input type="checkbox"/> French <input type="checkbox"/> Italian <input type="checkbox"/> Spanish <input type="checkbox"/> Dutch <input checked="" type="checkbox"/> Auto (English)	0
DIRECTORY LOCK = OFF	Do you lock / unlock the PS Dialling Directory? (Directory Lock Control)	<input type="checkbox"/> lock (ON) <input checked="" type="checkbox"/> Unlock (OFF)	1
QUICK ANSWER = ON	Do you prefer to answer an incoming call by just lifting your ringing PS off the Charger? (Quick Answering Mode Set)	<input type="checkbox"/> No (OFF) <input checked="" type="checkbox"/> Yes (ON)	0
AUTO ANSWER = OFF	Do you prefer to answer a call without lifting your PS using the headset? (Automatic Answer Mode Set)	<input checked="" type="checkbox"/> No (OFF) <input type="checkbox"/> Answer all calls. (INT/CO) <input type="checkbox"/> Answer only intercom calls. (INT ONLY)	0
AUTO ANS DELAY = OFF	Select the number of rings before answering a call automatically when using the headset. (Automatic Answer Delay Selection)	<input type="checkbox"/> [] ringers <input checked="" type="checkbox"/> 1 ring	0
ACCESS DECT-SYS = DECT-SYS1	Do you prefer to change the DECT system (1 through 4)? (DECT System Selection)	<input type="checkbox"/> DECT System no. [] <input type="checkbox"/> AUTO (All connected terminals) <input checked="" type="checkbox"/> Your registered DECT system no.	2
STANDBY DISPLAY = OFF	Which standby display do you prefer? (Standby Display Selection)	<input type="checkbox"/> Extension no. (EXT) <input type="checkbox"/> DECT system no. (DECT-SYS-NO.) <input type="checkbox"/> DECT system and extension no. (DECT-SYS-NO.&EXT) <input checked="" type="checkbox"/> None of these (OFF)	0

DECT
Portable Station

Customising Your PS

Display	Item	Selection	Level
DATE/TIME DISPLY = TIME	Which display do you prefer in the Standby mode? (Date / Time Display Selection)	<input type="checkbox"/> Date (DATE) <input checked="" type="checkbox"/> Date and time (TIME)	0
MEMORY CLEAR	The following settings will be returned to their default settings – Call log numbers – Ringer volume – Receiver volume – PS Programming items (except: Selecting the DECT System; Cancelling the PS Registration; Setting the PS Programming Password; Setting the DECT System Lock) Press OK after the display on the left appears. (Memory Clear)		1
CANCEL DECT-SYS = DECT-SYS1	After cancelling the PS registration in System Programming, cancel again by pressing OK after the display on the left appears. For details, consult your dealer. (PS Registration Cancellation)		2
GUIDANCE = OFF	Do you prefer the Guidance menu to help you operate your PS? (Guidance Menu Set)	<input type="checkbox"/> Yes (ON) <input checked="" type="checkbox"/> No (OFF)	0
PS PASSWORD = DISABLE	Do you prefer to use the PS Programming password? (PS Programming Password Set)	<input type="checkbox"/> Yes (ENABLE) <input checked="" type="checkbox"/> No (DISABLE)	1
DECT-SYS LOCK = DISABLE	Do you prefer to use the DECT System Lock password? (DECT System Lock Password Set)	<input type="checkbox"/> Yes (ENABLE) <input checked="" type="checkbox"/> No (DISABLE)	2

PBX Programming

You can enter into the proprietary wired telephone (PT) programming mode and program several items for your PS.
The available programs are listed below.

Initial Settings

Preferred Line Assignment – Outgoing

Customising the Buttons

Charge Fee Management

For more details, refer to “Customising Your Phone (Station Programming)” (Customising Your Phone & System).

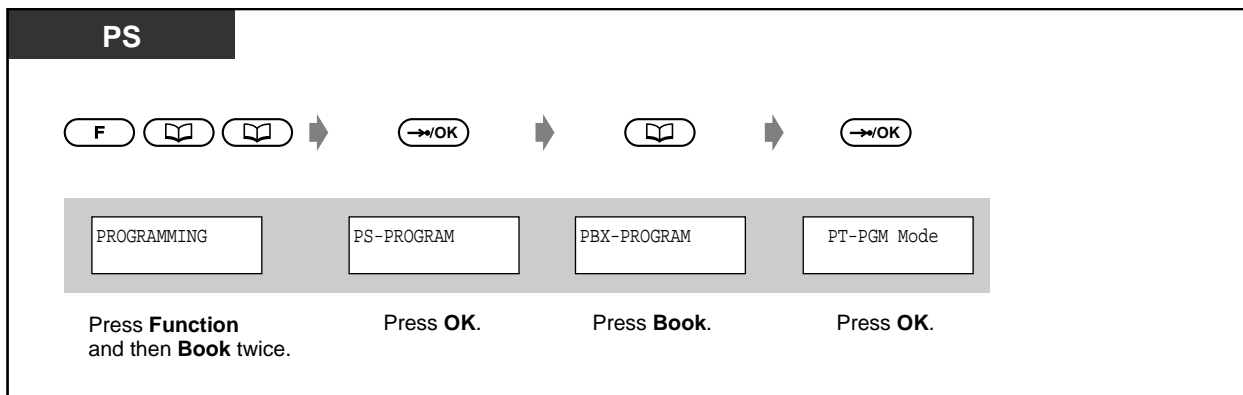

◆◆ **To enter the PBX programming mode**



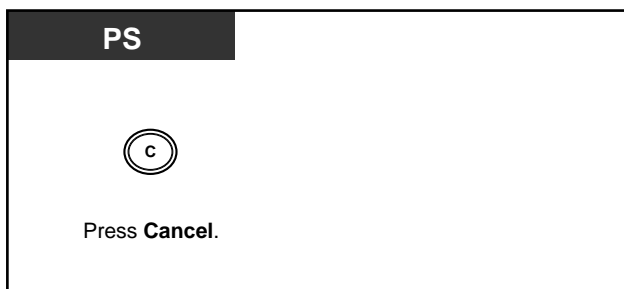

◆◆ **To exit the PBX programming mode**



Troubleshooting

Problem	Remedy
The PS does not work.	<ul style="list-style-type: none"> • The battery is empty. Charge the batteries fully. • The PS has been cancelled or the PS has not been registered. To register the PS, please consult with your dealer.
The PS does not operate.	<ul style="list-style-type: none"> • The power switch is OFF. Turn it ON .
The PS does not ring.	<ul style="list-style-type: none"> • Ringer volume is set to OFF or VIBRATION. • The PS is out of range or the Cell Station (CS) is busy. • The radio channel is busy or a radio communication error occurred. Try again later.
You cannot dial.	<ul style="list-style-type: none"> • The number which you dialled is restricted by the system. • The key lock mode is set. To cancel the mode, press the Function for about 2 seconds. • The radio channel is busy or a radio communication error occurred. Try again later.
Static, sound cuts in/out, fades. Interference from other electrical units.	<ul style="list-style-type: none"> • Set the PS and CS away from other electrical appliances. • Move closer to the CS.
“CS Busy” is displayed.	<ul style="list-style-type: none"> • The Cell Station is busy. Try again later.
“PS NOT CONNECTED” is displayed.	<ul style="list-style-type: none"> • The power switch is set to OFF. • The PS is out of range. • The radio channel is busy or a radio communication error occurred. Try again later.
You cannot store a phone number and name in the directory.	<ul style="list-style-type: none"> • Your entry exceeds the maximum digits or characters. • Do not pause for over 30 seconds while programming.
The alarm sounds after pressing the Redial button.	<ul style="list-style-type: none"> • A number is not saved in the Call Log.
“” flashes or beeps tones sound every 5 seconds during a conversation.	<ul style="list-style-type: none"> • The battery is low. Charge the batteries fully.
You charged the batteries fully, but “” flashes.	<ul style="list-style-type: none"> • Clean the charge contacts and charge again. • It is time to change the batteries. Please purchase new batteries.
The PS stops working during operation.	<ul style="list-style-type: none"> • Turn the power switch OFF and ON. Then try again. • Re-insert the battery and try again.
Handover does not work.	<ul style="list-style-type: none"> • You moved to a busy CS or are out of range. • You moved while not having a conversation (e.g., while hearing a busy tone). • The radio channel is busy or a radio communication error occurred.

Problem	Remedy
<p>The display does not show a strong radio signal “ <ul style="list-style-type: none"> • Normally, the PS user can make a call even with a “ <p>The alarm sounds during a conversation while receiving a weak radio signal “ <ul style="list-style-type: none"> • The radio signal is weak. Move closer to the CS. </p></p>	



Appendix

This chapter provides the Troubleshooting, Feature Number List, Directory, Tone List, Specifications and the Quick Reference Card for a Single Line Telephone. Check the Troubleshooting before consulting your dealer.

Troubleshooting

Problem	Remedy
The telephone does not work properly.	<ul style="list-style-type: none">• The wiring is wrong.<ul style="list-style-type: none">➔ Check the wiring.• The system does not work properly.<ul style="list-style-type: none">➔ Restart the system. (☞ P. 1-7)
I cannot use the telephone.	<ul style="list-style-type: none">• The telephone is locked.<ul style="list-style-type: none">➔ Unlock your telephone. (☞ P. 2-52, 3-3)• Your telephone is connected to an eXtra Device Port.<ul style="list-style-type: none">➔ System programming is required. Consult your dealer.
Some features do not work.	<ul style="list-style-type: none">• System management may restrict certain features.<ul style="list-style-type: none">➔ Consult your manager.• The feature numbers have changed.<ul style="list-style-type: none">➔ Confirm the revised number and try again.
Even though following the manual instructions, none of the operations work when using a proprietary telephone.	<ul style="list-style-type: none">• The Intercom line was not seized. The seized line, when going off-hook, was changed by personal setting. (☞ P. 4-2)<ul style="list-style-type: none">➔ In the manual, going off-hook means an Intercom line is seized. <p>If the setting has been changed, press the INTERCOM button after going off-hook and follow the instructions.</p>
The paralleled single line telephones do not ring.	<ul style="list-style-type: none">• This is the default setting.<ul style="list-style-type: none">➔ Change the setting to ring. (☞ P. 2-71)
The telephone does not work using the personal settings or with other settings. (One-touch dialling, forwarding destination, etc.)	<ul style="list-style-type: none">• The extension line has been changed. The previous telephone's settings have not be cleared.<ul style="list-style-type: none">➔ Clear the settings and then programme your desired settings again. (☞ P. 2-73, 4-3, 4-6)
My proprietary telephone does not have a function button.	<ul style="list-style-type: none">• Some models do not have the function button.<ul style="list-style-type: none">➔ Change a flexible button to the desired button. (☞ P. 4-4)➔ Enter the specified feature number instead of the function button. (☞ P. 2-2)
I cannot make an outside call.	<ul style="list-style-type: none">• The telephone is locked.<ul style="list-style-type: none">➔ Unlock your telephone. (☞ P. 2-52, 3-3)• Toll restriction is activated.<ul style="list-style-type: none">➔ Consult your manager or dealer.• An account code is required. (☞ P. 2-22, 4-7)• Another PBX is connected to your system.<ul style="list-style-type: none">➔ A host PBX access code is required. (☞ P. 2-77)• Nothing was dialled within 10 seconds after going off-hook.<ul style="list-style-type: none">➔ Hang up, off-hook and re-dial again.
A reorder tone is audible or "Restricted" is displayed.	<ul style="list-style-type: none">• The telephone is locked.<ul style="list-style-type: none">➔ Unlock your telephone. (☞ P. 2-52, 3-3)• Toll restriction is activated.<ul style="list-style-type: none">➔ Consult your manager or dealer.• An account code is required. (☞ P. 2-22, 4-7)



Problem	Remedy
I cannot make an outside call using the One-Touch Dialling button or speed dialling.	<ul style="list-style-type: none">• A line access number was not stored.<ul style="list-style-type: none">➔ A line access number is required for outside calls. (☞ P. 2-9, 2-92, 4-4)
I cannot remember the feature numbers.	<ul style="list-style-type: none">➔ Ask your dealer to change the feature numbers for easier use.➔ Store the feature numbers into the One-Touch Dialling buttons. (☞ P. 4-4)
Redialling does not function.	<ul style="list-style-type: none">• The stored number was more than 24 digits or an extension number. (☞ P. 2-14)
I do not want to show my identification number to the calling or called party's telephone.	(☞ P. 2-68, 2-69)
I want to show my identification number to the calling or called party's telephone.	(☞ P. 2-67)
I cannot send a call waiting tone to the dialled extension.	<ul style="list-style-type: none">• The other party has not set the Call Waiting feature. (☞ P. 2-17, 2-18, 2-38, 2-65)• The other party has set Data Line Security.<ul style="list-style-type: none">➔ Consult your dealer.
I forgot the lock code / Live Call Screening Password.	<ul style="list-style-type: none">➔ Ask the Operator or manager to assist you. (☞ P. 3-3)
The background music started suddenly.	<ul style="list-style-type: none">➔ Turn off the music. (☞ P. 2-70, 3-7)
I do not want to display a number which is stored in memory.	<ul style="list-style-type: none">➔ Conceal the number. (☞ P. 2-92, 4-5)
The display does not show the message described in the manual.	<ul style="list-style-type: none">• The telephone is not a Panasonic proprietary telephone.<ul style="list-style-type: none">➔ This manual shows messages which appear only on Panasonic proprietary telephones (e.g. KX-T7436). (☞ P. 2-3)
I want to confirm my extension number and jack number.	(☞ P. 4-9)
The date and time are not correct.	<ul style="list-style-type: none">• Set the date and time by system programming. (☞ P. 4-14)
The display is abnormal.	<ul style="list-style-type: none">• The lithium battery for memory back-up needs to be replaced.<ul style="list-style-type: none">➔ Consult your dealer.
I want to distinguish the tones.	(☞ P. 4-3, 4-5)
I hear a warning tone from the telephone.	<ul style="list-style-type: none">• The handset was off-hook in an idle status for an extended period of time.<ul style="list-style-type: none">➔ Replace the handset.

Troubleshooting

Problem	Remedy														
The MESSAGE button light lit.	<ul style="list-style-type: none"> • Another extension left you a message waiting indication during you were on the phone or left your desk. 														
“System Data Err 1” is displayed at the operator 1’s telephone.	<ul style="list-style-type: none"> • There is a wrong system data with back up RAM for master system. ➔ Consult your dealer. 														
“System Data Err 2” is displayed at the operator 1’s telephone.	<ul style="list-style-type: none"> • There is a wrong system data with back up RAM for slave system. ➔ Consult your dealer. 														
“Check Printer” is displayed at the operator 1’s telephone.	<ul style="list-style-type: none"> • The paper of the printer runs out or the printer is out-of-service. ➔ Consult your manager or dealer. 														
“System Link Down” is displayed at the operator 1’s telephone.	<ul style="list-style-type: none"> • System inter-connection is down. ➔ Consult your dealer. 														
A Power Failure occurred.	<p>When a power failure occurs... The system and Panasonic proprietary telephones stop all functions. Specific single line telephones are automatically connected straight to specific CO lines. This provides CO line conversations between the single line telephone and the following CO lines:</p> <table data-bbox="669 1087 1024 1308"> <tr> <td>KX-TD816</td> <td>KX-TD1232</td> </tr> <tr> <td>CO01</td> <td>CO01</td> </tr> <tr> <td>CO02</td> <td>CO02</td> </tr> <tr> <td>CO05</td> <td>CO09</td> </tr> <tr> <td></td> <td>CO13</td> </tr> <tr> <td></td> <td>CO14</td> </tr> <tr> <td></td> <td>CO21</td> </tr> </table> <p>All intercom calls and features do not function. When turning the power back on... Your system restarts with the stored data automatically. Memory is protected by a pre-installed lithium battery. There is no memory loss except for Automatic Callback Busy (Reserving a busy line) and Held calls.</p>	KX-TD816	KX-TD1232	CO01	CO01	CO02	CO02	CO05	CO09		CO13		CO14		CO21
KX-TD816	KX-TD1232														
CO01	CO01														
CO02	CO02														
CO05	CO09														
	CO13														
	CO14														
	CO21														

Feature Number List

Numbers listed below are the default settings. There are flexible feature numbers and fixed feature numbers. If you change the flexible feature numbers, fill in your assigned numbers in the list for future reference.

Feature	Default	Assigned no.	Additional digits
Calling the operator	0		
Automatic line access number / ARS	9		
Outside line number	8		1-8
Calling a pre-set party by going off-hook / cancelling / storing	74		1 / 0 / 2+phone no.+#
Calling using the number stored at your extension	6*		0-9
Storing the numbers	60		[0-9]+phone no.+#
Calling using the number stored in the system	*		000-499
Redialling the last phone number you dialled	#		
Reserving a busy line / Completing a call to a busy party on an ISDN line (CCBS)	6	Fixed	
Cancel the reserving of a busy line	46		
Cancelling the CCBS setting	713		
Sending a call waiting tone	2	Fixed	
Leaving a message waiting indication / cancelling / calling back / clearing a received indication	70		1+ext. no. / 0+ext. no. / 2 / 0+your ext. no.
Joining an existing call	3	Fixed	
16th incoming call log is stored / disregarded	56		1 / 0
Picking up a call for someone else – outside call	4*		
– group	40		
– direct	41		ext. no.
Holding or retrieving a call	50		
Retrieving from another extension – outside call	53		01-24
– intercom call	51		ext. no.
Holding in a system parking zone or retrieving	52		0-9
Paging or transferring and paging	63		* / 00 / 01-16
– all devices / all extensions /group			
– external speaker	62		1-4
Answering a paged announcement or an incoming call through the speaker	42		1-4
Answering the paged announcement through telephones	43		
Accessing external services	64		
Forwarding your call – All calls / Busy / No answer / Busy, No answer	710		[2 / 3 / 4 / 5]+ ext. no.
– to an external party			6+line access no. +phone no.+#
– cancel			0
– Follow Me/cancel	▼		[7 / 8]+your ext. no.

Feature Number List

Feature	Default	Assigned no.	Additional digits
Refusing all calls (DND) – forwarding to extension / operator / no backup station	710		1+[ext. no. / 0 / *]
– cancelling	↓		0
Forwarding calls from a receiving group	714		1+forwarding group no.+destination group or ext. no. / 0+forwarding group no.
Refusing direct outside calls (DND or DDI) / cancelling	54		1 / 0
Showing a message to the caller / cancelling	750		[1-9]+(parameter) / 0
Joining the call receiving group / leaving	45		[1 / 0]+ [group no. or * (all)]
Conference	3	Fixed	
Calling with account codes	49		code+[# or 99]
Temporary tone dialling	*#	Fixed	
Dialling a DND extension	2	Fixed	
Setting the alarm / cancelling / viewing	76		1+time+ [0 (once) / 1 (daily)] / 0 / 2
Receiving or refusing a call waiting tone or voice no tone / tone / OHCA / whisper OHCA	731		0 / 1 / 2 / 3
Displaying your number on the called / calling party's telephone – showing a number assigned for an outside line / your extension	711		1 / 2
– showing a desired number when making a particular call	↓		3+desired no.+#
Preventing your number being displayed on the called party's telephone / showing / changing the setting when making a particular call	59		2 / 0 / 1
Preventing your number being displayed on the calling party's telephone / showing	57		1 / 0
Denying other people the possibility of – seeing your call logs / allowing	59		3 digit code twice / stored code
– using your telephone / allowing	77		3 digit code twice / stored code
– picking up your calls / allowing	720		1 / 0
– paging through the speaker / allowing	721		1 / 0
– joining your conversation / allowing	733		1 / 0
Day / Night service confirmation	#	Fixed	
Switching the display – day, month, time / day, month, year, day of the week	*	Fixed	
Paralleled telephones ring / do not ring	69		1 / 0

Feature	Default	Assigned no.	Additional digits
Switching the calling method (Ring / Voice)	*	Fixed	
Cancelling the feature settings	790		
Calling the doorphone	61		1-2
Opening the door from a specified phone	55		1-2
from any extension while talking	5	Fixed	
Forwarding doorphone calls to outside parties	716		[1-2 or * (all)]+[1 / 0]
– setting / cancelling	715 ↓		[0 (day) / 1 (night)]+ [1-2 or * (all)]+line access no.+phone no.+#
– storing the phone number			/ [0 (day) / 1 (night)]+ [1-2 or * (all)]+#
– clear the phone number			
Overwriting the oldest call in call log / disregarding	56		1 / 0
*Assigning level of service – primary / secondary	79		[1 / 3]+ext. no.
*Setting the Live Call Screening password / cancelling	799		3 digit code twice / stored code
Hotel use features	7		1+ext. no.+time+ [0 (once) / 1 (daily)] /
– Setting the alarm for other extensions / cancelling / viewing			0+ext. no. / 2+ext. no.
– Printing out guest room information	750		[6-9]+(parameter)
*Turning on / off the background music	65		
Switching the Day / Night service	78		0 / 1 / 2
– automatic / to day / to night			
*Recording an outgoing message / playing back	712		[1 / 2]+OGM no.
*Printing out the system working report / clearing	794		1 / 0

* : Operator only

Directory

◆◆ Extension

Jack no.	Extension no.	Name	Jack no.	Extension no.	Name
01-1			01-2		
02-1			02-2		
03-1			03-2		
04-1			04-2		
05-1			05-2		
06-1			06-2		
07-1			07-2		
08-1			08-2		
09-1			09-2		
10-1			10-2		
11-1			11-2		
12-1			12-2		
13-1			13-2		
14-1			14-2		
15-1			15-2		
16-1			16-2		
17-1			17-2		
18-1			18-2		
19-1			19-2		
20-1			20-2		
21-1			21-2		
22-1			22-2		
23-1			23-2		
24-1			24-2		
25-1			25-2		
26-1			26-2		
27-1			27-2		
28-1			28-2		
29-1			29-2		
30-1			30-2		
31-1			31-2		
32-1			32-2		



Jack no.	Extension no.	Name	Jack no.	Extension no.	Name
33-1			33-2		
34-1			34-2		
35-1			35-2		
36-1			36-2		
37-1			37-2		
38-1			38-2		
39-1			39-2		
40-1			40-2		
41-1			41-2		
42-1			42-2		
43-1			43-2		
44-1			44-2		
45-1			45-2		
46-1			46-2		
47-1			47-2		
48-1			48-2		
49-1			49-2		
50-1			50-2		
51-1			51-2		
52-1			52-2		
53-1			53-2		
54-1			54-2		
55-1			55-2		
56-1			56-2		
57-1			57-2		
58-1			58-2		
59-1			59-2		
60-1			60-2		
61-1			61-2		
62-1			62-2		
63-1			63-2		
64-1			64-2		

Directory

◆◆ System Speed Dialling

No.	Name	No.	Name	No.	Name
000		043		086	
001		044		087	
002		045		088	
003		046		089	
004		047		090	
005		048		091	
006		049		092	
007		050		093	
008		051		094	
009		052		095	
010		053		096	
011		054		097	
012		055		098	
013		056		099	
014		057		100	
015		058		101	
016		059		102	
017		060		103	
018		061		104	
019		062		105	
020		063		106	
021		064		107	
022		065		108	
023		066		109	
024		067		110	
025		068		111	
026		069		112	
027		070		113	
028		071		114	
029		072		115	
030		073		116	
031		074		117	
032		075		118	
033		076		119	
034		077		120	
035		078		121	
036		079		122	
037		080		123	
038		081		124	
039		082		125	
040		083		126	
041		084		127	
042		085		128	



	Name	No.	Name	No.	Name
129		174		219	
130		175		220	
131		176		221	
132		177		222	
133		178		223	
134		179		224	
135		180		225	
136		181		226	
137		182		227	
138		183		228	
139		184		229	
140		185		230	
141		186		231	
142		187		232	
143		188		233	
144		189		234	
145		190		235	
146		191		236	
147		192		237	
148		193		238	
149		194		239	
150		195		240	
151		196		241	
152		197		242	
153		198		243	
154		199		244	
155		200		245	
156		201		246	
157		202		247	
158		203		248	
159		204		249	
160		205		250	
161		206		251	
162		207		252	
163		208		253	
164		209		254	
165		210		255	
166		211		256	
167		212		257	
168		213		258	
169		214		259	
170		215		260	
171		216		261	
172		217		262	
173		218		263	

Directory

	Name	No.	Name	No.	Name
264		309		354	
265		310		355	
266		311		356	
267		312		357	
268		313		358	
269		314		359	
270		315		360	
271		316		361	
272		317		362	
273		318		363	
274		319		364	
275		320		365	
276		321		366	
277		322		367	
278		323		368	
279		324		369	
280		325		370	
281		326		371	
282		327		372	
283		328		373	
284		329		374	
285		330		375	
286		331		376	
287		332		377	
288		333		378	
289		334		379	
290		335		380	
291		336		381	
292		337		382	
293		338		383	
294		339		384	
295		340		385	
296		341		386	
297		342		387	
298		343		388	
299		344		389	
300		345		390	
301		346		391	
302		347		392	
303		348		393	
304		349		394	
305		350		395	
306		351		396	
307		352		397	
308		353		398	



	Name	No.	Name	No.	Name
399		433		467	
400		434		468	
401		435		469	
402		436		470	
403		437		471	
404		438		472	
405		439		473	
406		440		474	
407		441		475	
408		442		476	
409		443		477	
410		444		478	
411		445		479	
412		446		480	
413		447		481	
414		448		482	
415		449		483	
416		450		484	
417		451		485	
418		452		486	
419		453		487	
420		454		488	
421		455		489	
422		456		490	
423		457		491	
424		458		492	
425		459		493	
426		460		494	
427		461		495	
428		462		496	
429		463		497	
430		464		498	
431		465		499	
432		466			

◆◆ **Station Speed Dialling**

Name	No.	Name	No.
	0		5
	1		6
	2		7
	3		8
	4		9

What is This Tone?

◆◆ While on-hook

Ring Tones

Tone 1

- Incoming call from an external party
- An outside call is held for more than a specified time (default: 60 seconds).



Tone 2

- Incoming call from an extension
- An intercom call is held for more than a specified time (default: 60 seconds).



Tone 3

- Incoming call from a doorphone
- The pre-set alarm time has arrived.



Tone 4

- A reserved outside line or extension became idle.
- A caller is leaving a message in your mailbox (Live Call Screening-Private mode).

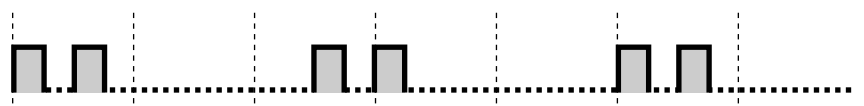

◆◆ When going off-hook

Dial Tones

Tone 1

Normal



Tone 2

At least one feature has been changed from the default setting at your extension.

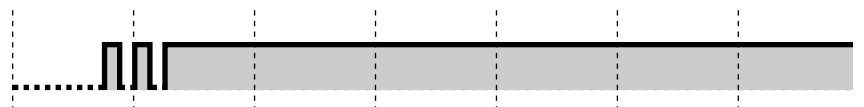

Tone 3

- The alarm is being answered.
- Enter an account code to turn off the tone.



Tone 4

A call waiting indication was received.



What is This Tone?

◆◆ When you make calls

Busy Tone



CCBS Tone

The called party on an ISDN line is busy.



Reorder Tone

- The outside line you tried to seize is not assigned or denied.
- The wrong account code was entered.



Ringback Tone



Do Not Disturb Tone

The dialed extension is refusing incoming calls.



◆◆ While off-hooking

Indication Tones

Tone 1

Call Waiting tone (default)

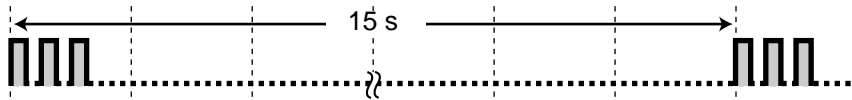

Tone 2

Call Waiting tone from outside



Tone 3

Call Waiting tone from another extension

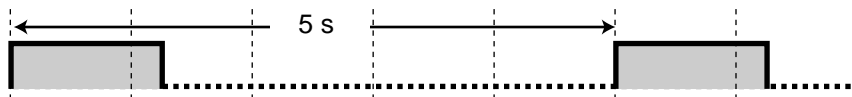

Tone 4

A call is held for more than a specified time (default: 60 seconds).

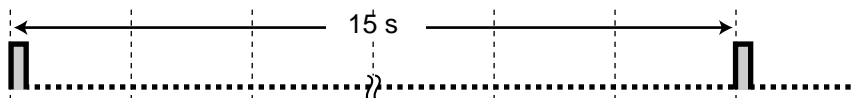

◆◆ When talking to an external party

Warning Tone

This tone is sent 15, 10 and 5 seconds before the time limit.

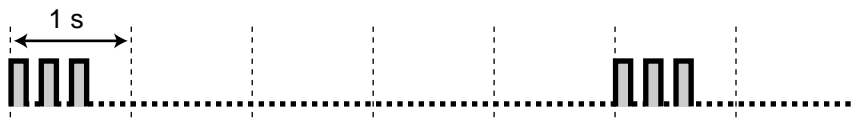

◆◆ *When setting the features or programming*

Confirmation Tones

Tone 1

- Set/cancel to deny other people the possibility of using your phone.
- The new setting differs from the previous setting by personal programming.
- Completing the system programming.

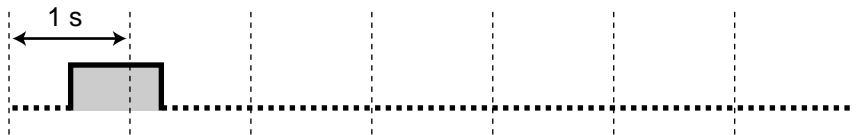

Tone 2

- The feature setting was completed successfully.
- Before paging through an external speaker
- The new setting is same as the previous setting by personal programming.



Tone 3

Before performing the following features:

- Retrieving a held call
- Picking up another call
- Paging/Answering a paged announcement
- Answering the call through a speaker



Tone 4

Establishing or leaving a three-party conversation

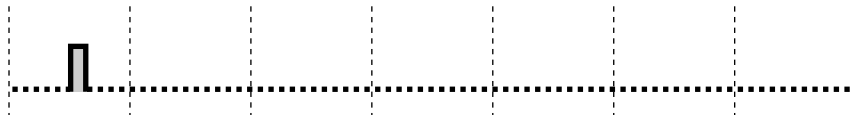

Specifications

◆◆ General Description

Item	Description			
System Capacity		Basic	Expansion	System Connection
	KX-TD816			
	Outside lines	0	8	—
	Extension lines	8	16	—
	(Extension lines with XDP	16	32	—)
	KX-TD1232			
Outside lines	0	12	24	
Extension lines	16	32	64	
(Extension lines with XDP	32	64	128)	
Power Supplies	Primary	230 VAC, 50 Hz		
	Secondary	Station Supply Volt: 30V Circuit Volt: ± 5V, ± 15V		
	Power Failure	<ul style="list-style-type: none"> • Memory backup duration: seven years with a factory-provided lithium battery • 2 outside lines max. for KX-TD408, 3 outside lines max. for KX-TD816 and 6 outside lines max. for KX-TD1232 automatically assigned to stations (Power Failure Transfer) • System operation for about three hours using recommended batteries (consisting of two 12 VDC car batteries) 		
Dialling	Outward/Internal Mode Conversion	Dial Pulse (DP) 10 pps, Tone (DTMF) Dialling DP-DTMF, DTMF-DP		
SMDR (Station Message Detail Recording)	Interface	V. 24 (RS-232C)		
	Output Equipment	Printer		
	Detail Recording	Date, Time, Extension Number, Outside Line Number, Dialed Number, Ring Duration, Call Duration, Account Code, Department Code, Charge Fee		

◆◆ Characteristics

Item	Description
Maximum Number of Station Instruments per Line	1 or 2 by Parallel or eXtra Device Port Connection
Ring Voltage	65 Vrms at 32 Hz depending on the ringing load
Environmental Requirements	0 – 40 °C, 10 – 90% relative humidity

Please cut out these cards and distribute to the single line telephone users.

Quick Reference Card

To Make Calls

- Intercom: Ext. no.
- Operator: 0
- External Party: 9 or 81-88 + Phone no.
- Station Speed Dialling: 6 X + No. 0-9
- System Speed Dialling: X + No. 000-499
- Doorphone: 6 1 + Doorphone no.



When a Line is Busy

- Reserving a busy line: 6
- Sending a call waiting tone: 2
- Redialling the last dialled number: #

To Pick Up Someone's Call

- Outside Call: 4 X
- Specified Extension: 4 1 + Ext. no.
- Extension Group: 4 0

During a Conversation

- Holding: (Recall) + 5 0 + 
- Retrieving: (Recall) + 5 0
- Transferring: (Recall) + Dial no.
- Answering Call Waiting: (Recall) + 5 0 +  + 

Quick Reference Card

To Make Calls

- Intercom: Ext. no.
- Operator: 0
- External Party: 9 or 81-88 + Phone no.
- Station Speed Dialling: 6 X + No. 0-9
- System Speed Dialling: X + No. 000-499
- Doorphone: 6 1 + Doorphone no.



When a Line is Busy

- Reserving a busy line: 6
- Sending a call waiting tone: 2
- Redialling the last dialled number: #

To Pick Up Someone's Call

- Outside Call: 4 X
- Specified Extension: 4 1 + Ext. no.
- Extension Group: 4 0

During a Conversation

- Holding: (Recall) + 5 0 + 
- Retrieving: (Recall) + 5 0
- Transferring: (Recall) + Dial no.
- Answering Call Waiting: (Recall) + 5 0 +  + 

Quick Reference Card

To Make Calls

- Intercom: Ext. no.
- Operator: 0
- External Party: 9 or 81-88 + Phone no.
- Station Speed Dialling: 6 X + No. 0-9
- System Speed Dialling: X + No. 000-499
- Doorphone: 6 1 + Doorphone no.



When a Line is Busy

- Reserving a busy line: 6
- Sending a call waiting tone: 2
- Redialling the last dialled number: #

To Pick Up Someone's Call

- Outside Call: 4 X
- Specified Extension: 4 1 + Ext. no.
- Extension Group: 4 0

During a Conversation

- Holding: (Recall) + 5 0 + 
- Retrieving: (Recall) + 5 0
- Transferring: (Recall) + Dial no.
- Answering Call Waiting: (Recall) + 5 0 +  + 

Quick Reference Card

To Make Calls

- Intercom: Ext. no.
- Operator: 0
- External Party: 9 or 81-88 + Phone no.
- Station Speed Dialling: 6 X + No. 0-9
- System Speed Dialling: X + No. 000-499
- Doorphone: 6 1 + Doorphone no.



When a Line is Busy

- Reserving a busy line: 6
- Sending a call waiting tone: 2
- Redialling the last dialled number: #

To Pick Up Someone's Call

- Outside Call: 4 X
- Specified Extension: 4 1 + Ext. no.
- Extension Group: 4 0

During a Conversation

- Holding: (Recall) + 5 0 + 
- Retrieving: (Recall) + 5 0
- Transferring: (Recall) + Dial no.
- Answering Call Waiting: (Recall) + 5 0 +  + 

Please cut out these cards and distribute to the single line telephone users.

Locking / Unlocking Your Phone
• Lock: 7 7 + 3 digit desired code + same code
• Unlock: 7 7 + Stored code
Settings
• Storing the number for Station Speed Dialling: 6 0 + No. 0-9 + Line no. 9 or 81-88 + Phone no. + #
• Call Waiting: — Set: 7 3 1 1 — Cancel: 7 3 1 0
Frequently Used Features at Your Extension

Locking / Unlocking Your Phone
• Lock: 7 7 + 3 digit desired code + same code
• Unlock: 7 7 + Stored code
Settings
• Storing the number for Station Speed Dialling: 6 0 + No. 0-9 + Line no. 9 or 81-88 + Phone no. + #
• Call Waiting: — Set: 7 3 1 1 — Cancel: 7 3 1 0
Frequently Used Features at Your Extension

Locking / Unlocking Your Phone
• Lock: 7 7 + 3 digit desired code + same code
• Unlock: 7 7 + Stored code
Settings
• Storing the number for Station Speed Dialling: 6 0 + No. 0-9 + Line no. 9 or 81-88 + Phone no. + #
• Call Waiting: — Set: 7 3 1 1 — Cancel: 7 3 1 0
Frequently Used Features at Your Extension

Locking / Unlocking Your Phone
• Lock: 7 7 + 3 digit desired code + same code
• Unlock: 7 7 + Stored code
Settings
• Storing the number for Station Speed Dialling: 6 0 + No. 0-9 + Line no. 9 or 81-88 + Phone no. + #
• Call Waiting: — Set: 7 3 1 1 — Cancel: 7 3 1 0
Frequently Used Features at Your Extension

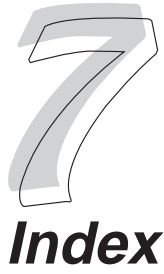

NOTE: Index is not fixed yet.

Index

- A**bsent Message2-46
- ABST MSG Off / Absent MSG Off.....2-47, 2-48
- ABST MSG On 1-9 / Absent MSG On (1-9)
.....2-46, 2-47
- ACCNT.....2-21
- Account2-21, 4-4, 4-7, 5-15
- Adding Telephone.....ii, 1-6, 2-69
- Alarm.....2-58, 3-12, 3-16, 5-15
- Alert3-11, 4-4
- Alternate Calling — Ring / Voice2-23
- Announce → Paging
- ANSWER.....2-5, 3-9
- Answering → Receiving Calls
- At Ext %%% (extension no.)2-46
- AUTO ANSWER2-5, inside back cover
- AUTO DIAL2-5, inside back cover
- Automatic
 - Callback Busy2-15
 - Log.....2-83
 - Night Service3-5
 - Overflow.....3-4
 - Redial.....2-14
 - Route Selection.....ii, 2-9
- B**ack at %:%% (Hour:Minute)2-46
- Background Music (BGM)2-67, 3-7
- BGM2-67
- BSS (Busy Station Signalling) / BSS.....2-17
- Busy2-14, 2-15, 2-16, 2-17, 2-18, 2-42
- Busy Station Signalling (BSS)2-17
- Busy tone5-16
- Button.....2-5, 4-4, 4-5, 4-6, inside back cover
- C**amp-On → Automatic Callback Busy
- CALL.....2-83
- Call
 - Duration2-9, 2-85
 - Information.....2-9, 2-18, 2-24, 2-83, 2-85
 - Record.....ii, 2-85
- Caller ID2-24, 2-83, 2-85
- Call Forwarding2-42, 2-45, 2-76, 2-94
- Call Hold → Hold
- Calling → Making Calls
- Calling back2-83
- Calling method.....2-23
- Calling Line Identification Presentation (CLIP)
.....2-64
- Calling Line Identification Restriction (CLIR)
.....2-65, 4-5
- Call Log → Incoming Call Log
- Call Log.....2-89, 2-91
- Call Log Lock, Incoming → Incoming Call Log
- Call Park2-30
- Call Park 0-9 / Call Park (0-9)
.....2-31, 2-32
- Call Pickup.....2-26, 5-17
- Call Pickup Deny2-66, 4-5
- Call Splitting.....2-33
- Call Transfer → Transferring
- Call Waiting.....2-17, 2-36, 2-62, 4-5
 - Tone.....2-36, 2-78, 4-3, 5-16
- Cancelling → Clearing
- Capacity.....1-2, 5-18
- C.BCK.....2-15
- CCBS → Completion of Calls to Busy Subscriber
/ CCBS.....2-16
- Character4-12
- Charge Fee Management.....4-7
- Check in / Check out.....3-10
- Check-in / check-out3-10
- Clearing
 - Initial setting.....4-3
 - (Flexible) button data.....4-6
 - Live Call Screening Password.....2-78
 - Programs2-71
 - System working report.....3-15
- CLIP → Calling Line Identification Presentation
- CLIR → Calling Line Identification Restriction
- COLP → Connected Line Identification Presentation
- COLR → Connected Line Identification Restriction
- CLR2-83, 3-11, 3-13, 4-7, 4-9
- CO.....2-4, 2-5, 2-9, 4-4, inside back cover
- Completion of Calls to Busy Subscriber (CCBS)
.....2-16
- CONF.....2-5, 4-4, inside back cover
- Conference2-37, 5-17
- Confirmation.....2-2, 4-3, 4-7, 4-9, 5-17
- Connected Line Identification Presentation
(COLP).....2-64
- Connected Line Identification Restriction (COLR)



2-66, 4-5

Connection1-6, 2-69

Control extension3-2

COS (Class of Service).....3-2

COS Primary ext / COS Primary (ext).....3-2

COS Second ext / COS Second (ext).....3-2

C.Pickup GRP / C.Pickup Group.....2-26, 2-27

Customise4-1

Date2-83, 4-14

Day / Night2-68, 3-5

Default Set → Clearing

Denying

Displaying your number on the called party's
telephone.....2-65

Displaying your number on the calling party's
telephone.....2-66

Paged announcement2-63, 4-5

Ringling (DND)2-60, 2-61

Joining your conversation2-67

Picking up your calls.....2-66

Retrieving your held calls2-30

Seeing your call log2-86

Using your telephone2-49, 3-3

Department code4-7

Dial Tone.....5-15

Direct Outside Calls2-61

Directed Call Pickup
Directory5-8

Direct Station Selection → DSS

Display

.....2-2, 2-3, 2-83, 2-87, 4-9, inside back cover

Display feature list2-93

DND → Do Not Disturb, FWD/DND

DND (→0/*/ext)2-60, 2-94

DND for DDI2-61, 4-5

Do Not Disturb (DND)
.....2-5, 2-22, 2-60, 2-94, 5-16

Do Not Disturb Override2-22

Door Open2-74

Door Opener2-72

Doorphone1-5, 2-72, 5-15

Doorphone Call Forwarding to Outside Line
.....2-73, 4-5

DSS2-5, 2-8, 4-4

Easy Dialling.....2-10

EFA.....2-75

Electronic Station Lockout2-49, 3-3

Emergency call2-9

END3-10, 3-13

Exclusive Call Hold2-30

Executive Busy Override2-20

Executive Busy Override Deny.....2-67, 4-5

EXT2-88, 2-90

Extension.....2-87, 2-89, 2-91

Extension

Customise.....4-2

Dialling.....2-8, 2-87, 2-88, 2-89, 2-90, 2-91

Directory5-8

Group.....2-26, 2-51

Lock2-49, 3-3

Name / Number4-23

External Feature Access.....2-

External Party2-9, 2-35, 2-42

External Relay.....2-81

External Ringer2-82

External Sensor3-16

eXtra Device Port (XDP)ii, 1-6

Ext-BGM On/Off / Extrn BGM On/Off.....3-7

Facsimile (FAX)1-5

FEAT2-88, 2-90

Feature Access2-87

Feature Number2-2, 5-5

Features2-89, 2-91

Flexible CO2-5, 4-4, inside back cover

Follow Me.....2-42

Forwarding Calls2-42, 2-45, 2-76

Full One-Touch Dialling4-2

Function2-5, inside back cover

FWD → FWD/DND

FWD/DND2-5, 2-94, 4-4, inside back cover

FWD-All Calls (→ext).....2-43, 2-76

FWD-BSY N/A (→ext)2-43, 2-76

FWD-Busy (→ext).....2-43, 2-76

FWD-CO Line (→dial).....2-43

FWD/DND Cancel.....2-43, 2-60

FWD-From (→ext)2-43

FWD-From Cancel (→ext)2-43

Index

FWD-No Answer (→ext).....2-43, 2-76

Gone Home.....2-46

Greeting → Outgoing message

Group Call Pickup.....2-26

Guest room information3-14

Hands-free Answerback.....2-25

Hands-free mode2-78, 4-3

Hands-free operation.....2-9, 2-24

Handset.....4-3

Handset Mute.....2-40

Headset.....4-3

Hold (HOLD)2-5, 2-28, 5-15, inside back cover

Host PBX2-75

Hot Line → Pickup Dialling

Hotel3-10, 3-12, 3-13

Hotel Use Features3-10

Hurry-Up / Hurry-Up Transfer3-4, 4-4

Iconiii, 2-4, 4-10, inside back cover

Identification number2-64, 2-65, 2-66

In a Meeting2-46

Incoming Call Log2-83, 2-85, 2-86, 3-3

Indication Tone.....2-22, 2-36, 2-77, 5-16

INFO.....2-83

Initial Display.....2-83

Initial Settings.....4-2

INTERCOM.....2-5, inside back cover

Intercom Alert4-3

Intercom Call

.....2-8, 2-87, 2-88, 2-89, 2-90, 2-91, 4-3, 5-15

Interrupt2-17, 2-20

Jack number.....4-9

Joining

An existing call2-20, 2-38

Receiving group.....2-50

Key Click Tone4-3

Last Number Redial.....2-14

L-CO → Loop-CO

LCS → Live Call Screening

Leaving

Conference2-38

Message waiting indication.....2-18

Receiving group.....2-50

Line

Access number2-9

Name2-24, 2-83

Outside line.....1-2, 2-9

Selection → Preferred Line Assignment.....4-2

Live Call Screening (LCS)

.....2-78, 3-3, 4-3, 4-4, 5-15

Location1-3, inside back cover

Lock2-49, 3-3

Log.....2-85

Log-In/Log-Out.....2-50, 4-4

Loop-CO.....2-5, 2-9, 4-4

Mailbox.....2-76

Making Calls

.....2-8, 2-87, 2-88, 2-89, 2-90, 2-91, 4-2

Account Codes2-21

Call log2-83, 2-89, 2-91

Doorphone2-72

Easy Dialling.....2-10

Phantom2-13

Manager3-15

Manual Night Service.....3-5

Message.....2-18, 2-46, 2-78, 3-8

MESSAGE2-5, 4-4, inside back cover

Message Waiting.....2-18, 2-76, 5-15

Microphone2-40, inside back cover

Microphone Mute2-40

Minibar3-10

MODE2-5

Monitoring2-78

MSG Off ext / Message Off (ext) ...2-18, 2-19

MSG On ext / Message On (ext).....2-18, 2-19

Music → Background Music

Mute (MUTE)2-5, 2-40, inside back cover

Name.....1-3, inside back cover

Extension4-23

Character Entering.....4-12

Outside line.....2-24, 2-83

Station Speed Dialling2-92

System Speed Dialling.....4-16



New.....	2-83	Picking up	2-26, 5-17
Night.....	4-5	Pickup Dialling	2-12, 4-5
Night Service → Day / Night		Power Failure.....	5-18
Night Mode 0-2 /		Preferred Line	4-2
Night Auto/On/Off (0-2).....	3-5	Preventing Ringing.....	2-60
NO	3-10	PRINT.....	3-10
No Answer.....	2-15, 2-42, 2-76	Print out.....	ii, 1-5, 3-10, 3-14, 3-15
Notebook Function.....	2-39	Private mode	2-78, 4-3, 5-15
O ff-Hook Call Announcement (OHCA)		PROG.....	3-12
.....	2-17, 2-36, 2-62	PROGRAM	2-5, inside back cover
Off-Hook Monitor.....	2-41	Programming	4-1
OGM → Outgoing Message		Proprietary Telephone.....	1-5, 2-2, 4-2
OHCA → Off-Hook Call Announcement		Pulse to Tone.....	2-22
OLD.....	2-83	Q uick Dialling	2-13
One-Touch Dialling.....	2-10, 4-2, 4-4	Directory	5-14
One-Touch Transfer.....	2-35	R ECALL (for PT)	
Opening the door	2-74	2-5, 2-8, 2-14, inside back cover
Operations	2-1	Recall (for SLT).....	2-4, inside back cover
Operator.....	2-9, 3-1	Received group	2-45, 2-50, 4-4
Others	3-10	Receiving calls	2-24, 2-50, 4-2, 4-3
Outgoing Message (OGM)	3-8, 3-12	Call waiting	2-36
Outside	2-9, 2-26, 2-33, 2-36, 2-42, 2-61	Hands-free.....	2-24, 2-25
Outside (CO) Call Pickup.....	2-26	Mailbox	2-76, 2-78
Out until %/% (Month/Day)	2-46	Paging.....	2-56
Over	2-20, 2-22	Recording	
Overlay.....	4-8	Call log.....	ii, 2-85
P age E-ANS 1-4 /		Conversation.....	2-80
Page-Ext Answer (1-4)	2-28, 2-56	Outgoing message.....	3-8
Page Extrn 0-4 /		Redial (REDIAL)	
Paging External (0-4)	2-51, 2-52	2-5, 2-14, 2-89, 2-91, inside back cover
Page GRP 00-16 /		RELEASE	2-5, 3-9
Paging Group (00-16).....	2-52, 2-53	Remote Operation.....	3-1
Page-GRP ANS / Page-GRP Answer	2-57	Remote Station Lock Control.....	3-3
Paging	2-51, 5-17	Reorder Tone.....	5-16
Paralleled telephone.....	1-6, 2-69, 4-5	Reserve line	2-15
Parallel 1/0 /		Reset button	1-3, 1-8
Parallel On/Off (1/0)	2-69, 2-70	Restarting.....	1-8
PAUSE	2-5, inside back cover	Restriction	2-3, 2-21, 2-65, 2-66
Personal Computer.....	1-5	Ring.....	2-23, 4-3, 4-6, 5-15
Password	2-78, 3-3, 4-8, 4-11	S AVE	4-4
PF	2-5, 4-4	Saved Number Redial.....	2-14
Phantom	2-13, 4-4, 4-6	Saving a number.....	2-39

Index

SECRET4-5, 4-15
SEL.....4-7
SELECT.....2-5, 4-12
SHIFT.....2-5, inside back cover
Single-CO → CO
Single line telephone1-5, 1-6, 2-2, 2-4, 2-69
Soft2-5, inside back cover
Speaker1-5, 2-28, 2-51, inside back cover
Speakerphone → SP-PHONE
Specifications5-18
Speed Dialling → Station speed dialling /
 System Speed Dialling
SP-PHONE2-5, inside back cover
STA2-88, 2-90
STA Speed2-89, 2-91
Station Speed.....2-87
Station Program Clear → Clearing-Programs
 2-71
Station Message Detail Recording (SMDR)
 ii, 4-7, 5-18
Station speed dialling
 2-11, 2-87, 2-88, 2-89, 2-90, 2-91, 2-92
 Directory5-13
STORE2-5, inside back cover
SYS Speed.....2-89, 2-91
System Feature Access
 2-87, 2-88, 2-89, 2-90, 2-91
System Speed.....2-87
System speed dialling
 2-11, 2-87, 2-88, 2-89, 2-90, 2-91, 4-15, 4-16
 Directory5-10
System Working Report.....3-15

TAFAS → Trunk Answer From Any Station
Telephone.....ii, 1-5, 1-6, 2-2, 2-5
Telephone.....3-10
Temporary tone dialling2-22
Terminate.....2-9, 4-5
Three-party Conversation.....2-20, 3-36, 5-17
Time2-83, 2-85, 4-14
Time Limit.....2-29, 2-81, 5-16
Timed Reminder.....2-58, 3-11, 3-12, 5-15
Tone2-22, 5-15
 → Call Waiting – tone
 → Confirmation

Tone.....2-23
TRANSFER2-6, inside back cover
Transferring2-34, 2-54, 2-77
TRM.....2-9
Troubleshooting5-2
Trunk Answer From Any Station (TAFAS)....2-28
Two-Way Recording2-80, 4-4
Two-Way Transfer2-80, 4-4

Unattended Conference.....2-38, 5-17
Unlock2-49, 2-74, 2-86, 3-3

Voice.....2-23
Voice-Calling.....2-23
Voice mailii, 2-76, 4-3, 4-4
Voice processing systemii, 1-5, 2-76

Wake up / Wake-Up call.....3-12, 3-13
Wake-Up call → Timed Reminder
Will Return Soon2-46
Warning Tone5-3, 5-16
Whisper OHCA.....2-17, 2-36, 2-62







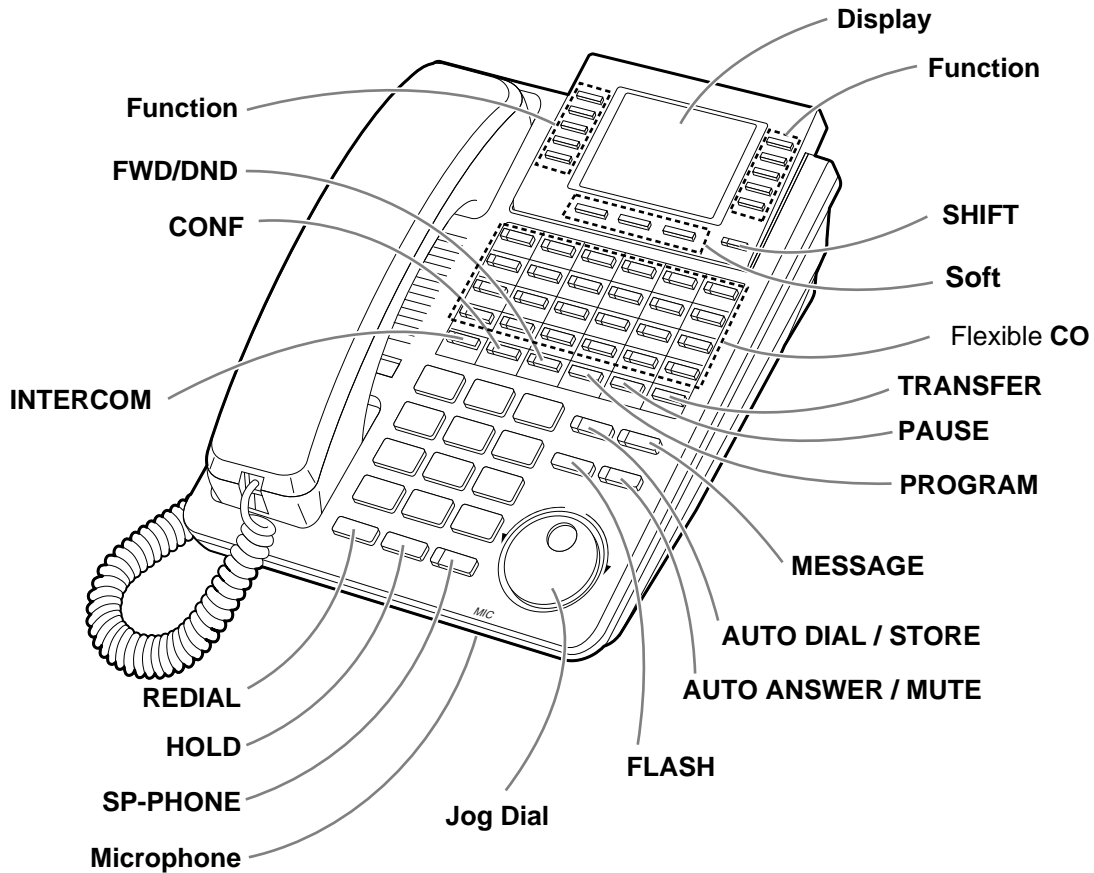





XDP → eXtra Device Port

YES3-10

◆◆ Names and Locations of the KX-T7436



◆◆ Icons

	Conditions		Press the Call button on the Doorphone.
	Hints		Press the Recall button on a single line telephone.
	Related Programming Title or Programming steps.		Wait for an answer.
	Not available for a single line telephone.		Talk.
	Off-hook.		You will hear a confirmation, dial, ring or ringback tone. C. Tone: confirmation tone D. Tone: dial tone R. Tone: ring tone R. B. Tone: ringback tone
	On-hook.		One short beep

Warning
This is a Class A product. In a domestic environment
this product may cause radio interference in which case
the user may be required to take adequate measures.



73/23/EEC
89/336/EEC
92/31/EEC
93/68/EEC

Panasonic Business Systems U.K.
Panasonic House, Willoughby Road, Bracknell,
Berkshire RG12 4FP

Printed in the United Kingdom

PSQX1835ZA KS06699MT0